

QUALITYLAV

ARTICOLI TECNICI IN GOMMA E SILICONE

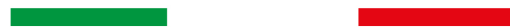

Catalogo

Profili a Disegno

Eseguibili in:

EPDM – Silicone

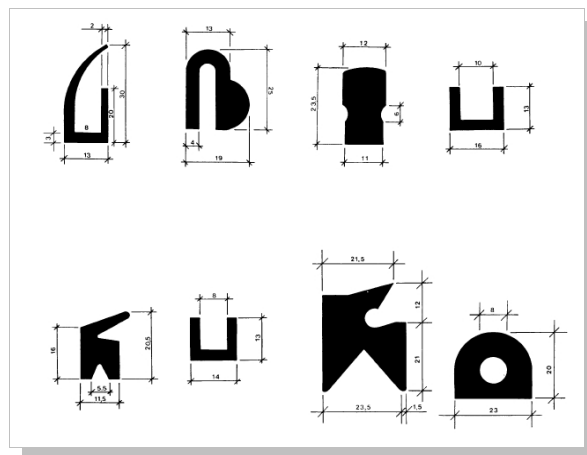

2023

ATTENZIONE:

Il peso in gr/mt, talora indicato, è teorico. Può variare infatti a seconda della mescola utilizzata per l'estrusione.

Alcune sezioni sono realizzabili solo con determinate mescole e durezza.

TAKE CARE:

The given weight/mtr has a theoretical value. The use of a different rubber can change this weight/mts.

Please take note that some profiles are realized only according to a precise silicone rubber or Shore degree.

ATTENTION:

Le poids par mètre, parfois indiqué, est théorique. En effet il peut changer selon le mélange employé.

Quelques profilés peuvent être boudinés seulement avec des mélanges de caoutchouc bien précis ou avec des duretés particulières.

BEMERKUNG:

Die angegebene Mtr. Gewichte sind als theoretische Werte anzusehen und können sich nach einzusetzender Gummimischung verändern.

Außerdem ist darauf zu achten, dass einige eingetragene Profile nur aus einer bestimmten Gummimischung, bzw, bestimmten Shore Härte realisierbar sind.

QUALITYLAV

ARTICOLI TECNICI IN GOMMA E SILICONE

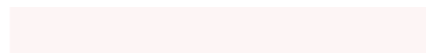

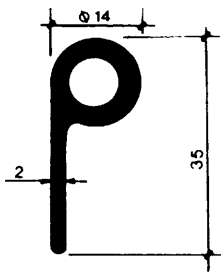

11 gr./mt. 170 60 Sh

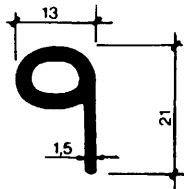

12 gr./mt. 97 60 Sh

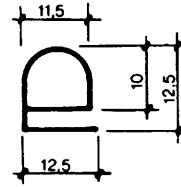

P 13 gr./mt. 95 60 Sh

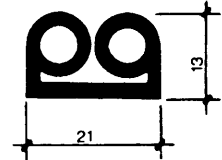

P 14 gr./mt. 165 60 Sh



P 15 gr./mt. 170 60 Sh

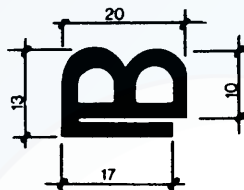

P 16 gr./mt. 163 60 Sh

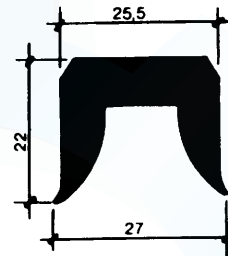

P 17 gr./mt. 375 60 Sh

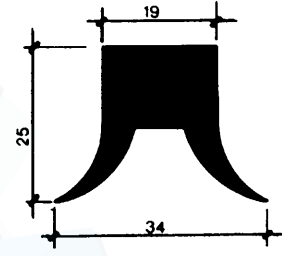

P 18 gr./mt. 450 60 Sh

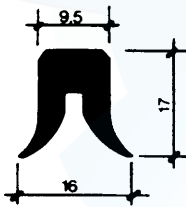

P 19 gr./mt. 175 60 Sh

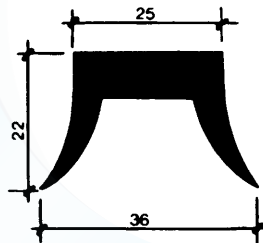

P 20 gr./mt. 384 60 Sh

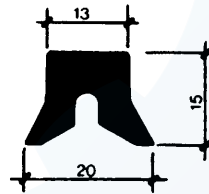

P 21 gr./mt. 222 60 Sh

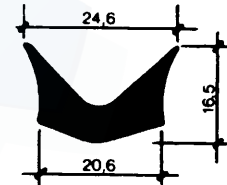

P 22 gr./mt. 200 60 Sh

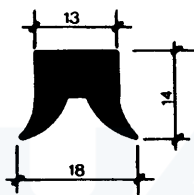

P 23 gr./mt. 202 60 Sh

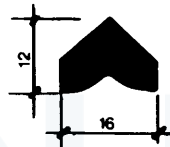

P 24 gr./mt. 130 60 Sh

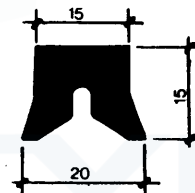

P 25 gr./mt. 270 60 Sh

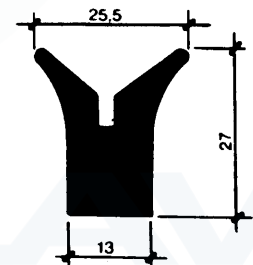

P 26 gr./mt. 403 65 Sh

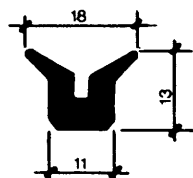

P 27 gr./mt. 200 60 Sh

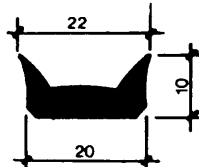

P 28 gr./mt. 160 60 Sh

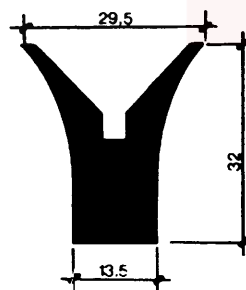

P 29 gr./mt. 430 60 Sh

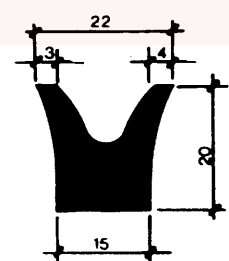

P 30 gr./mt. 336 60 Sh

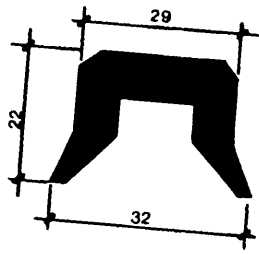

P 31 gr./mt. 570 60 Sh

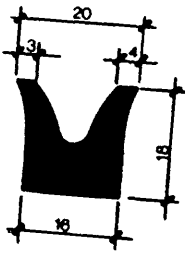

P 32 gr./mt. 340 60 Sh

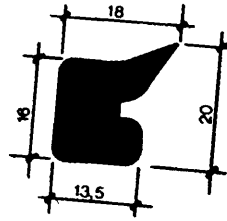

P 33 gr./mt. 320 60 Sh

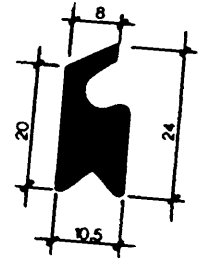

P 34 gr./mt. 235 60 Sh

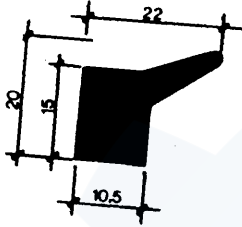

P 35 gr./mt. 260 65 Sh



P 36 gr./mt. 420 60 Sh

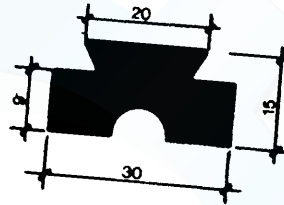

P 37 gr./mt. 450 65 Sh

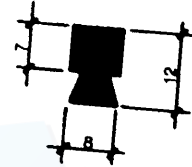

P 38 gr./mt. 115 60 Sh

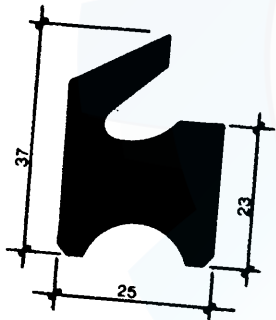

P 39 gr./mt. 713 60 Sh

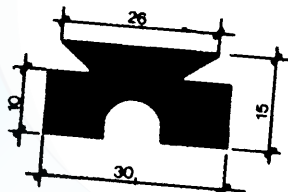

P 40 gr./mt. 500 60 Sh



P 41 gr./mt. 360 60 Sh

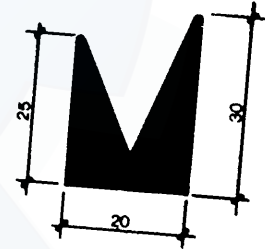

P 42 gr./mt. 500 70 Sh

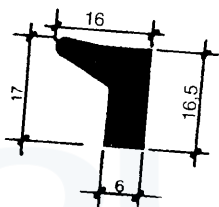

P 43 gr./mt. 175 65 Sh

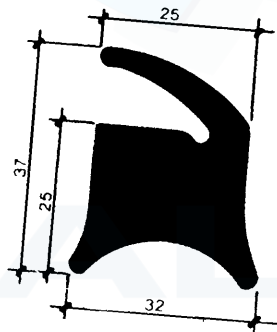

P 44 gr./mt. 784 60 Sh



P 45 gr./mt. 245 70 Sh

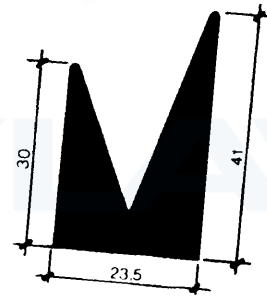

P 46 gr./mt. 800 70 Sh

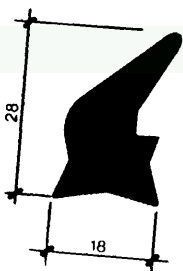

P 47 gr./mt. 335 65 Sh



P 48 gr./mt. 178 65 Sh

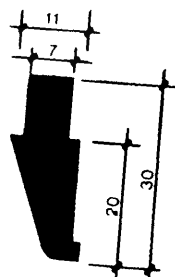

P 49 gr./mt. 310 70 Sh

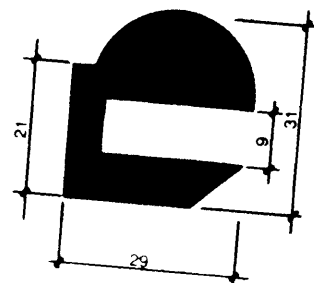

P 50 gr./mt. 700 60 Sh

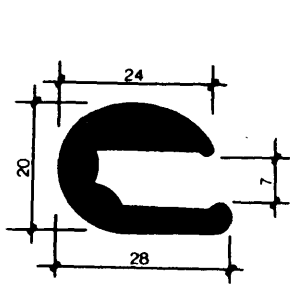

P 51 gr./mt. 360 60 Sh

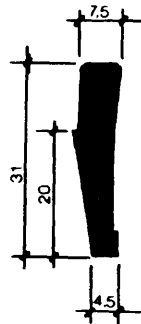

P 52 gr./mt. 270 65 Sh

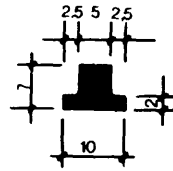

P 53 gr./mt. 60 70 Sh

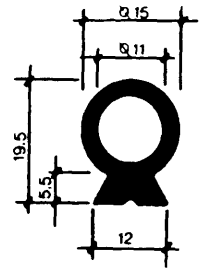

P 54 gr./mt. 178 60 Sh

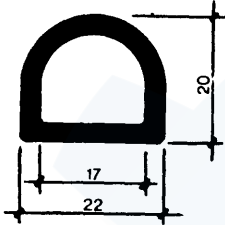

P 55 gr./mt. 210 60 Sh

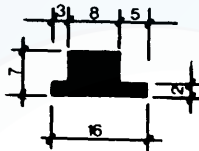

P 56 gr./mt. 110 60 Sh

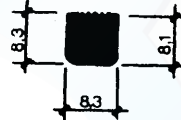

P 57 gr./mt. 93 60 Sh

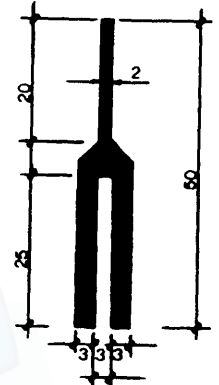

P 58 gr./mt. 300 60 Sh

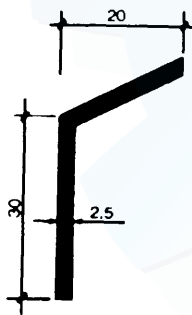

P 59 gr./mt. 195 60 Sh

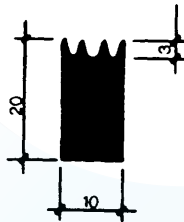

P 60 gr./mt. 250 55 Sh

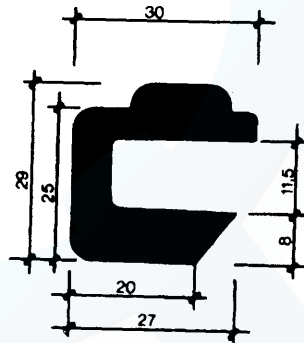

P 61 gr./mt. 590 60 Sh

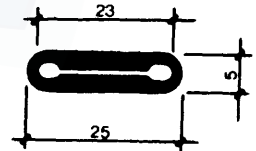

P 62 gr./mt. 136 60 Sh

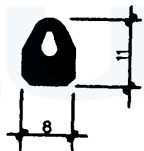

P 63 gr./mt. 70 60 Sh

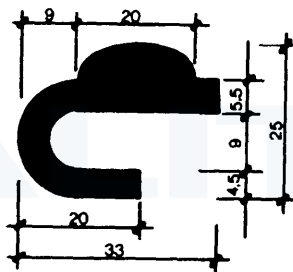

P 64 gr./mt. 533 55 Sh

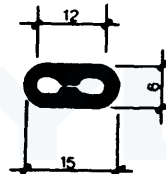

P 65 gr./mt. 70 60 Sh

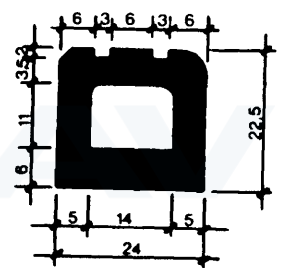

P 66 gr./mt. 500 50 Sh

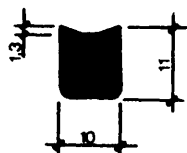

P 67 gr./mt. 140 60 Sh

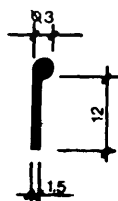

P 68 gr./mt. 33 60 Sh

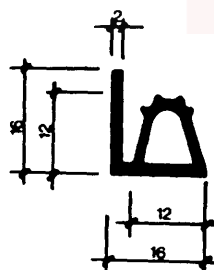

P 69 gr./mt. 130 55 Sh

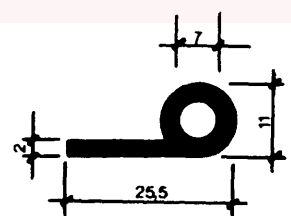

P 70 gr./mt. 150 60 Sh

ARTICOLI TECNICI IN GOMMA E SILICONE

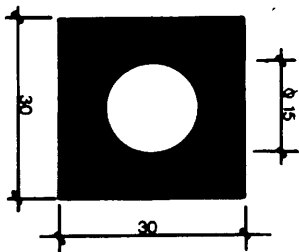

P 71 gr./mt. 980 60 Sh

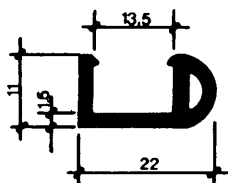

P 72 gr./mt. 100 60 Sh

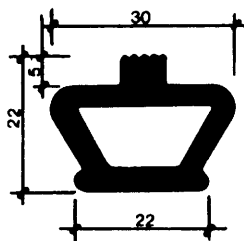

P 73 gr./mt. 330 60 Sh

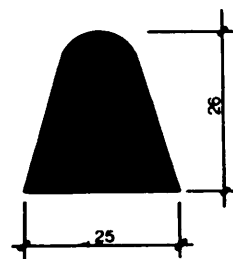

P 74 gr./mt. 600 60 Sh

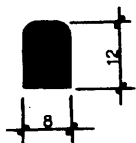

P 75 gr./mt. 130 60 Sh



P 76 gr./mt. 84 60 Sh

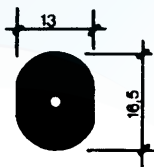

P 77 gr./mt. 260 60 Sh

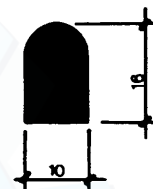

P 79 gr./mt. 190 60 Sh

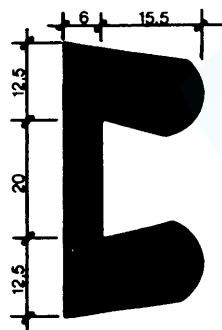

P 80 gr./mt. 860 60 Sh

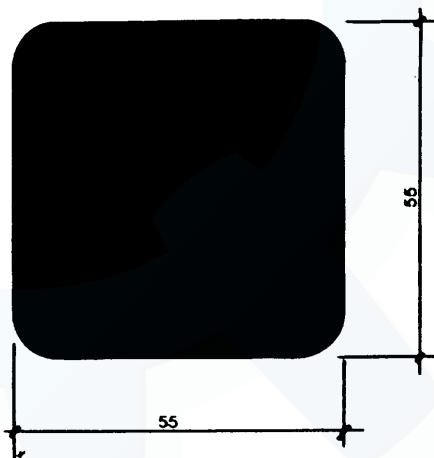

P 81 gr./mt. 3800 60 Sh

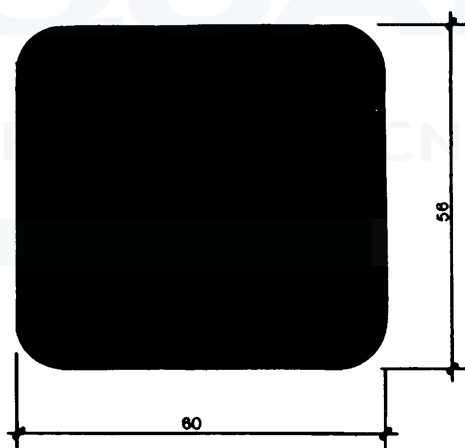

P 82 gr./mt. 4200 60 Sh

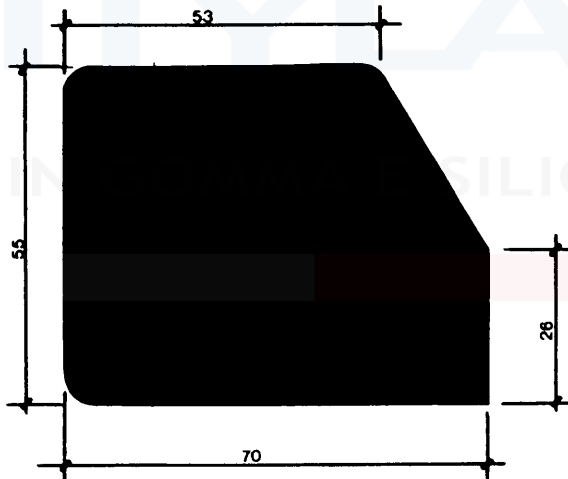

P 83 gr./mt. 4200 60 Sh

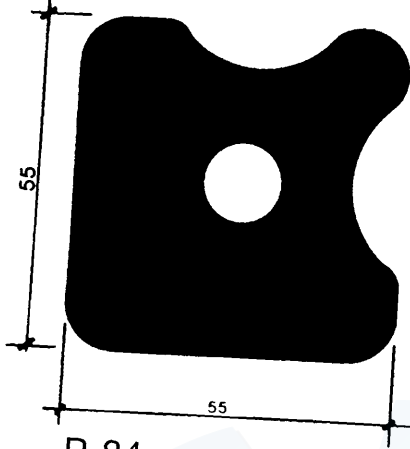

P 84 gr./mt. 3250 60 Sh

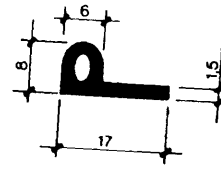

P 85 gr./mt. 60 60 Sh

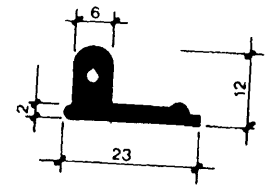

P 88 gr./mt. 117 65 Sh

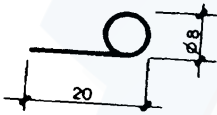

P 89 gr./mt. 62 60 Sh
SP = 1,5

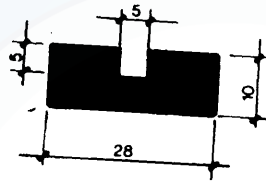

P 90 gr./mt. 330 60 Sh



P 91 gr./mt. 180 60 Sh



P 92 gr./mt. 36 60 Sh
SP = 1

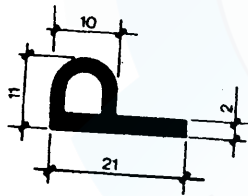

P 93 gr./mt. 120 60 Sh

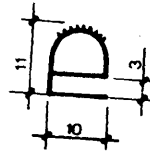

P 94 gr./mt. 70 60 Sh
SP = 1,5

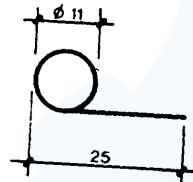

P 95 gr./mt. 100 55 Sh
SP = 2

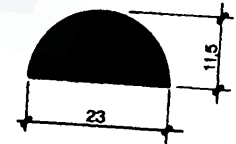

P 96 gr./mt. 270 60 Sh



P 97 gr./mt. 60 60 Sh

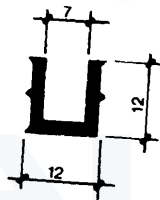

P 98 gr./mt. 80 60 Sh

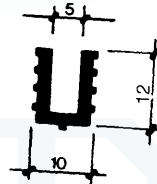

P 99 gr./mt. 84 60 Sh



P 100 gr./mt. 74 60 Sh

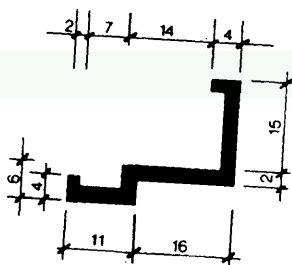

P 101 gr./mt. 130 60 Sh

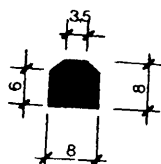

P 102 gr./mt. 78 60 Sh

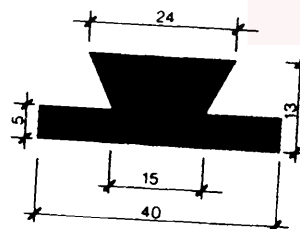

P 103 gr./mt. 510 60 Sh

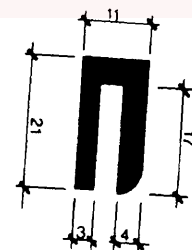

P 104 gr./mt. 199 60 Sh

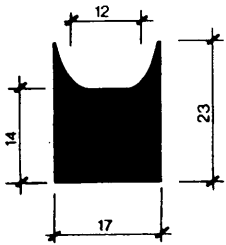

P 105 gr./mt. 340 60 Sh

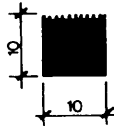

P 107 gr./mt. 130 60 Sh

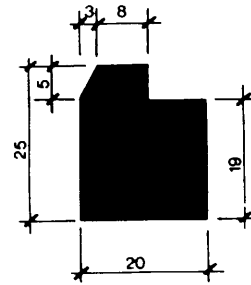

P 108 gr./mt. 555 60 Sh

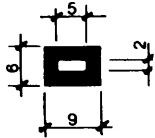

P 109 gr./mt. 55 55 Sh

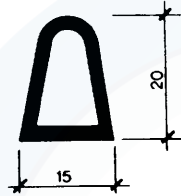

P 110 gr./mt. 150 60 Sh
SP = 2

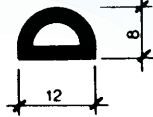

P 111 gr./mt. 63 60 Sh

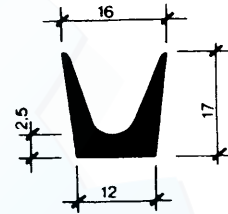

P 112 gr./mt. 120 60 Sh

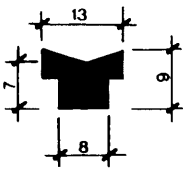

P 113 gr./mt. 94 60 Sh

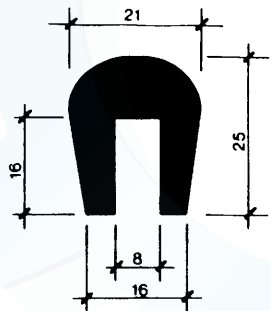

P 114 gr./mt. 425 60 Sh

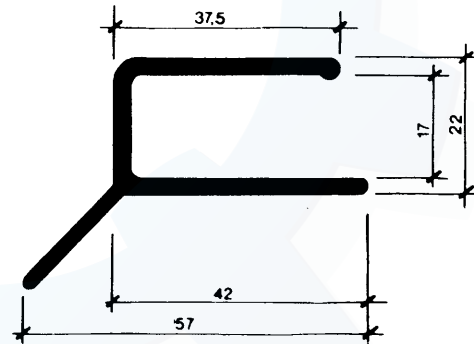

P 115 gr./mt. 480 60 Sh

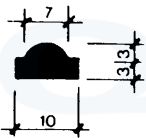

P 116 gr./mt. 65 60 Sh



P 117 gr./mt. 65 60 Sh
SP = 1

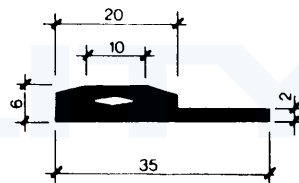

P 118 gr./mt. 300 60 Sh

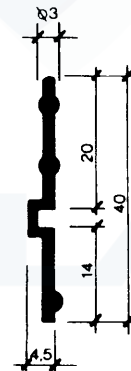

P 119 gr./mt. 145 60 Sh

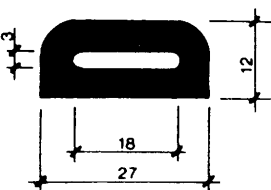

P 120 gr./mt. 350 60 Sh

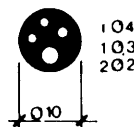

P 121 gr./mt. 88 60 Sh

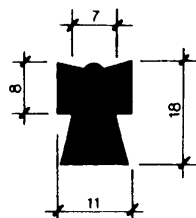

P 122 gr./mt. 280 60 Sh

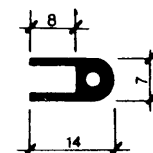

P 123 gr./mt. 75 60 Sh

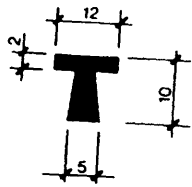

P 124 gr./mt. 88 60 Sh

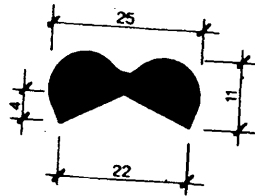

P 127 gr./mt. 300 60 Sh

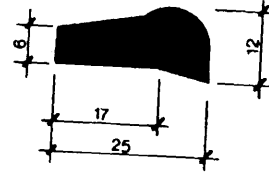

P 128 gr./mt. 270 60 Sh

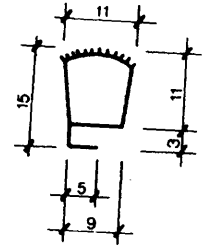

P 129 gr./mt. 67 60 Sh
SP = 1

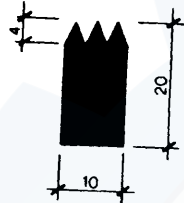

P 130 gr./mt. 250 55 Sh

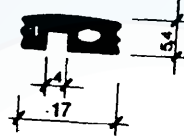

P 131 gr./mt. 107 60 Sh

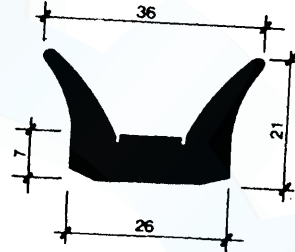

P 132 gr./mt. 430 60 Sh

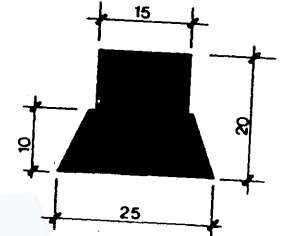

P 133 gr./mt. 455 60 Sh

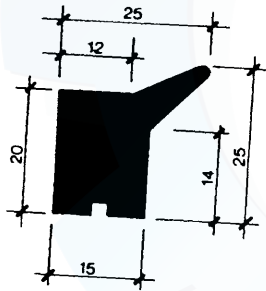

P 134 gr./mt. 440 55 Sh

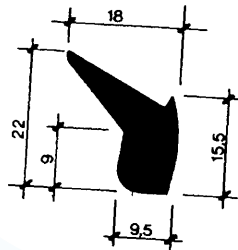

P 135 gr./mt. 178 60 Sh

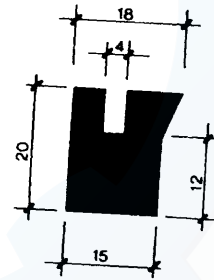

P 136 gr./mt. 374 60 Sh

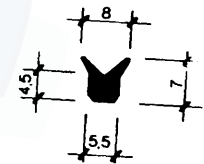

P 137 gr./mt. 46 60 Sh

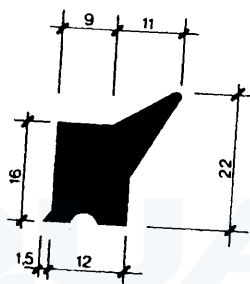

P 138 gr./mt. 305 60 Sh

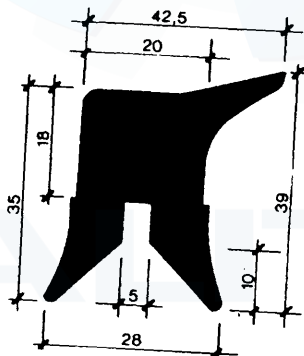

P 139 gr./mt. 940 60 Sh

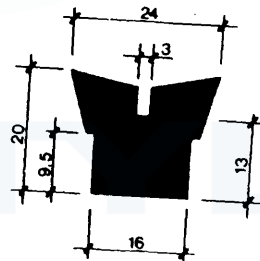

P 140 gr./mt. 440 60 Sh

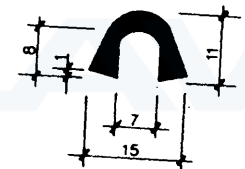

P 141 gr./mt. 95 60 Sh

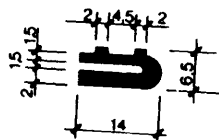

P 142 gr./mt. 83 55 Sh

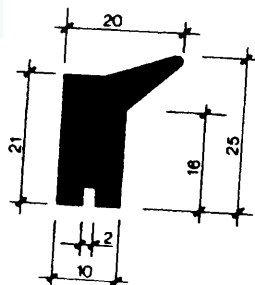

P 143 gr./mt. 370 60 Sh

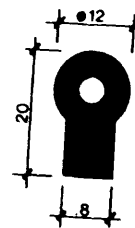

P 144 gr./mt. 220 65 Sh

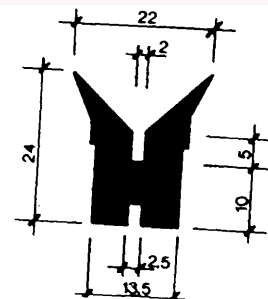

P 145 gr./mt. 340 60 Sh

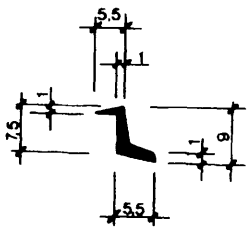

P 146 gr./mt. 18 60 Sh

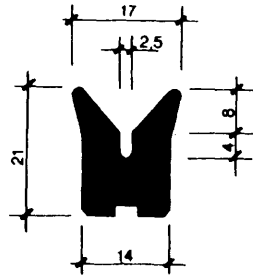

P 147 gr./mt. 300 60 Sh

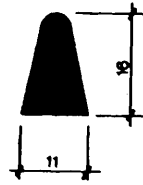

P 148 gr./mt. 160 60 Sh

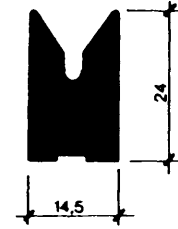

P 149 gr./mt. 430 60 Sh

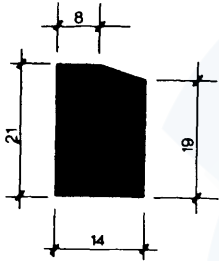

P 150 gr./mt. 375 60 Sh

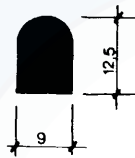

P 151 gr./mt. 145 60 Sh

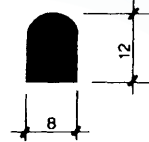

P 152 gr./mt. 130 60 Sh

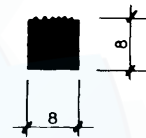

P 153 gr./mt. 81 60 Sh

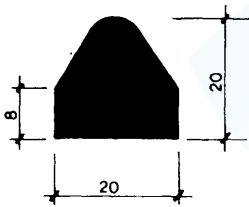

P 154 gr./mt. 430 Sh 60

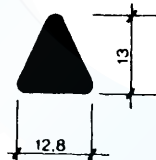

P 155 gr./mt. 110 60 Sh

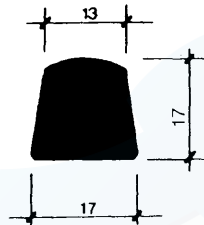

P 156 gr./mt. 335 60 Sh



P 157 gr./mt. 66 60 Sh

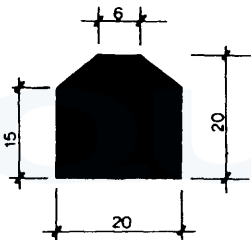

P 158 gr./mt. 475 Sh 60

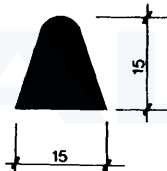

P 159 gr./mt. 205 60 Sh

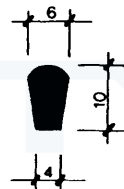

P 160 gr./mt. 65 60 Sh

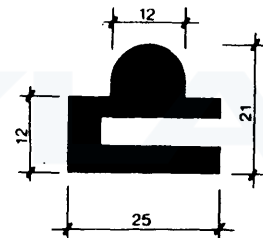

P 161 gr./mt. 380 60 Sh

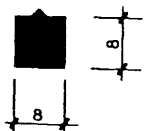

P 162 gr./mt. 90 60 Sh

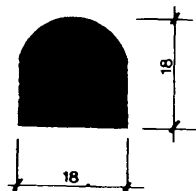

P 163 gr./mt. 357 60 Sh

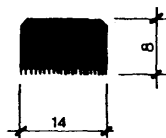

P 164 gr./mt. 145 60 Sh

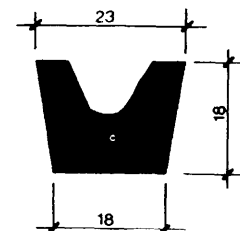

P 165 gr./mt. 357 65 Sh

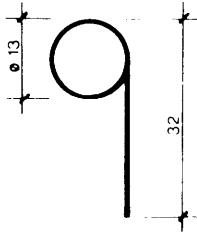

P 166 gr./mt. 165 60 Sh
SP = 2

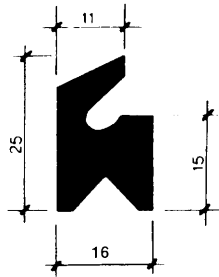

P 167 gr./mt. 323 60 Sh

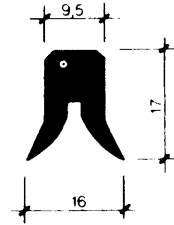

P 168 gr./mt. 200 60 Sh

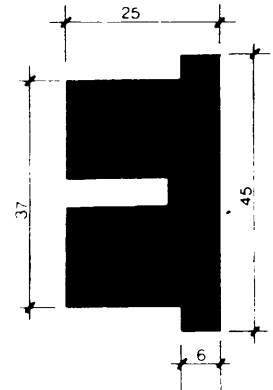

P 169 gr./mt. 1110 60 Sh

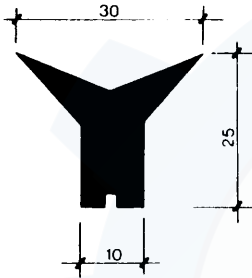

P 170 gr./mt. 440 60 Sh

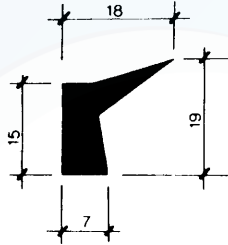

P 171 gr./mt. 150 60 Sh

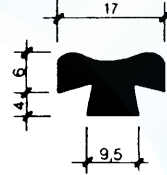

P 172 gr./mt. 165 60 Sh

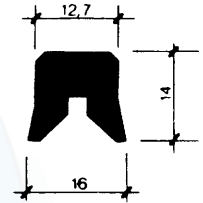

P 173 gr./mt. 200 60 Sh

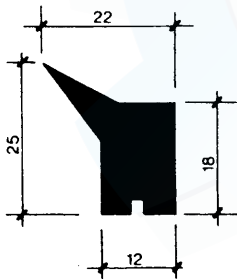

P 174 gr./mt. 300 65 Sh

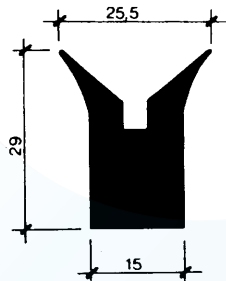

P 175 gr./mt. 450 60 Sh

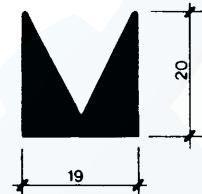

P 176 gr./mt. 290 60 Sh

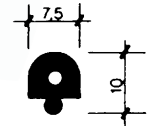

P 177 gr./mt. 65 60 Sh

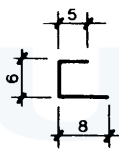

P 178 gr./mt. 22 60 Sh
SP = 1



P 179 gr./mt. 96 60 Sh

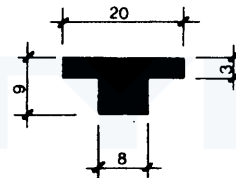

P 180 gr./mt. 140 60 Sh

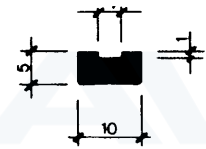

P 181 gr./mt. 67 60 Sh

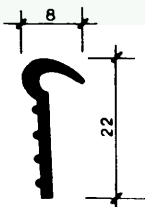

P 182 gr./mt. 87 60 Sh



P 183 gr./mt. 75 60 Sh

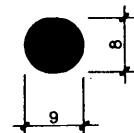

P 184 gr./mt. 75 60 Sh

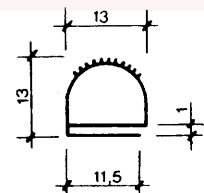

P 185 gr./mt. 121 60 Sh
SP = 1,5

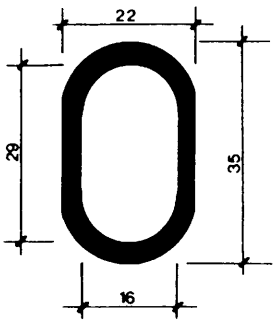

P 186 gr./mt. 325 60 Sh

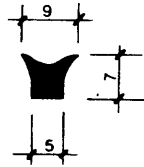

P 188 gr./mt. 65 70 Sh

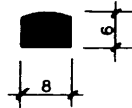

P 189 gr./mt. 56 70 Sh

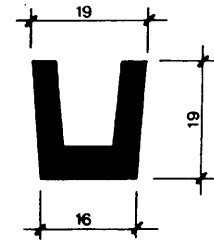

P 191 gr./mt. 240 60 Sh

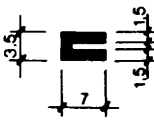

P 192 gr./mt. 27 60 Sh

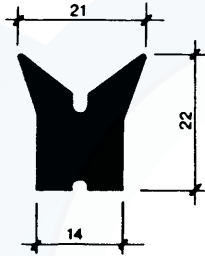

P 194 gr./mt. 430 60 Sh

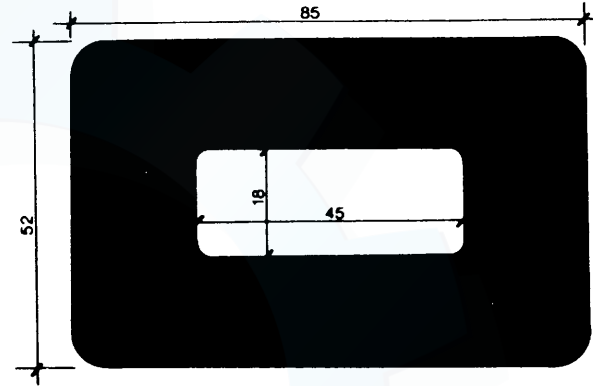

P 195 gr./mt. 4500 60 Sh

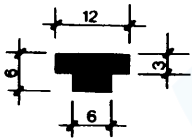

P 196 gr./mt. 70 60 Sh



P 197 gr./mt. 80 70 Sh

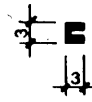

P 198 gr./mt. 10 60 Sh



P 204 gr./mt. 25 60 Sh

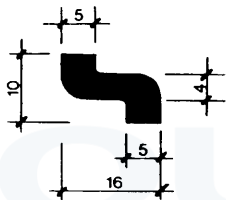

P 205 gr./mt. 125 60 Sh



P 206 gr./mt. 30 60 Sh

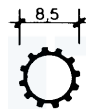

P 207 gr./mt. 47 70 Sh
SP=1

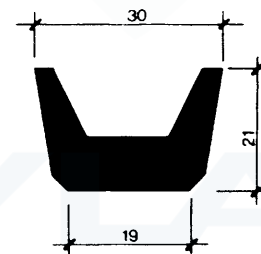

P 208 gr./mt. 400 60 Sh

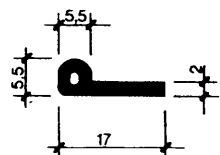

P 209 gr./mt. 62 60 Sh

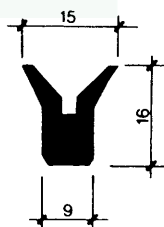

P 210 gr./mt. 175 70 Sh

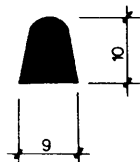

P 211 gr./mt. 115 60 Sh

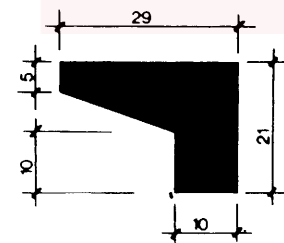

P 212 gr./mt. 410 60 Sh

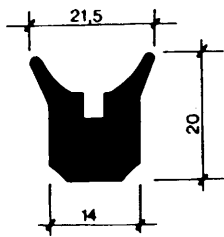

P 213 gr./mt. 250 60 Sh

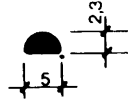

P 214 gr./mt. 14 70 Sh

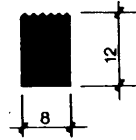

P 215 gr./mt. 130 60 Sh

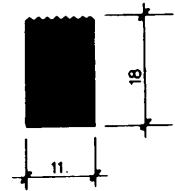

P 216 gr./mt. 250 60 Sh

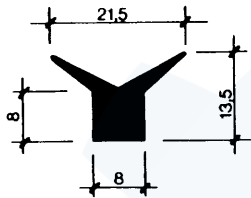

P 217 gr./mt. 135 60 Sh

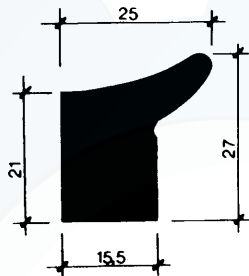

P 218 gr./mt. 470 60 Sh

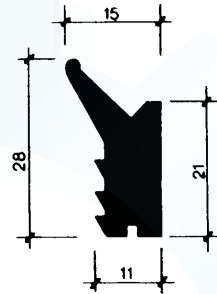

P 219 gr./mt. 296 60 Sh

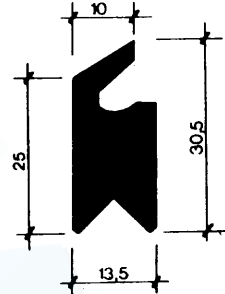

P 220 gr./mt. 400 70 Sh

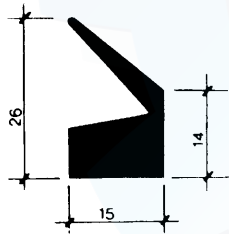

P 221 gr./mt. 225 60 Sh

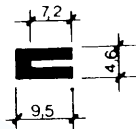

P 222 gr./mt. 36 60 Sh

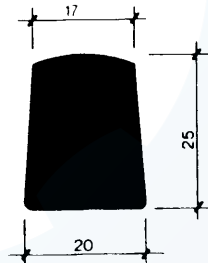

P 223 gr./mt. 585 60 Sh

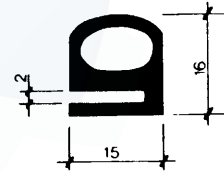

P 224 gr./mt. 165 60 Sh

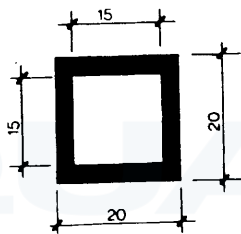

P 225 gr./mt. 230 60 Sh

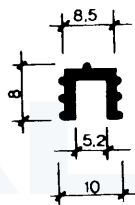

P 226 gr./mt. 60 60 Sh

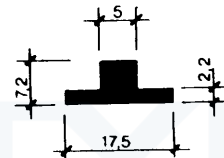

P 227 gr./mt. 80 70 Sh

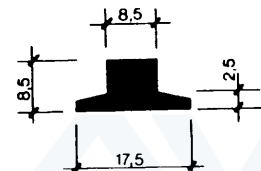

P 228 gr./mt. 120 70 Sh

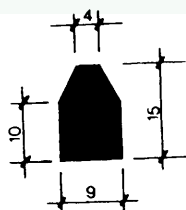

P 229 gr./mt. 140 60 Sh

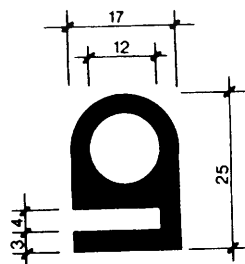

P 230 gr./mt. 335 60 Sh

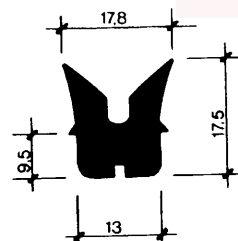

P 231 gr./mt. 270 60 Sh

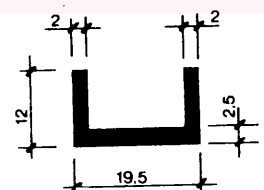

P 233 gr./mt. 120 60 Sh

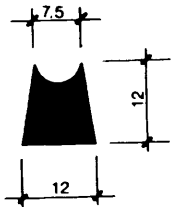

P 234 gr./mt. 155 60 Sh

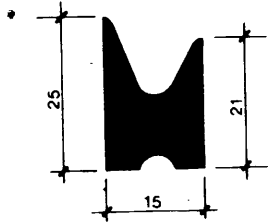

P 235 gr./mt. 350 60 Sh

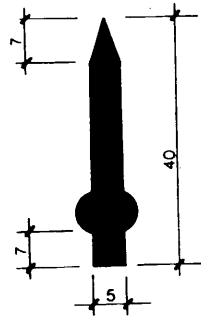

P 236 gr./mt. 260 60 Sh

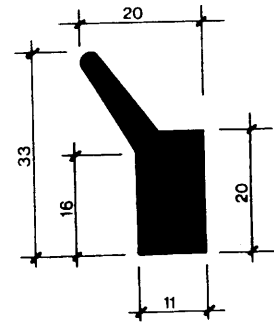

P 237 gr./mt. 350 60 Sh

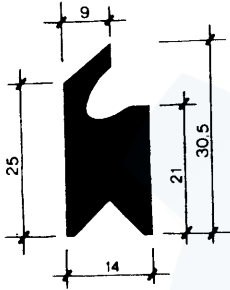

P 238 gr./mt. 400 70 Sh

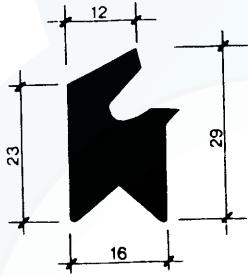

P 241 gr./mt. 351 70 Sh

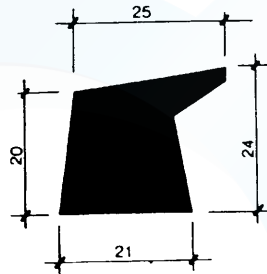

P 242 gr./mt. 610 60 Sh

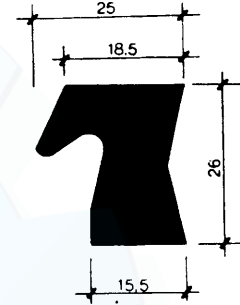

P 243 gr./mt. 560 60 Sh

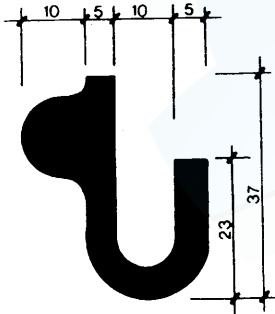

P 244 gr./mt. 600 60 Sh

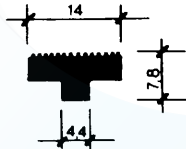

P 245 gr./mt. 90 70 Sh

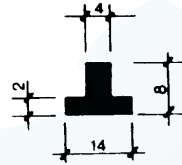

P 246 gr./mt. 55 60 Sh

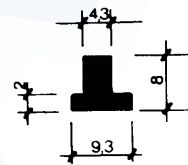

P 247 gr./mt. 58 60 Sh

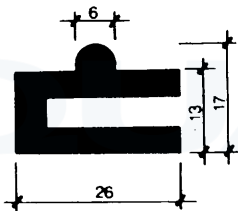

P 248 gr./mt. 325 60 Sh



P 249 gr./mt. 650 60 Sh

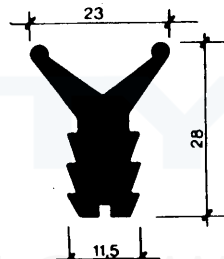

P 250 gr./mt. 335 60 Sh

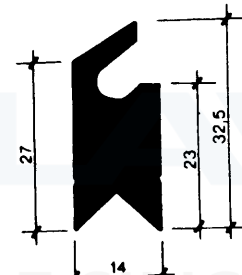

P 251 gr./mt. 455 60 Sh



P 252 gr./mt. 370 60 Sh



P 253 gr./mt. 150 60 Sh



P 254 gr./mt. 185 60 Sh

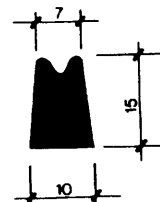

P 255 gr./mt. 160 70 Sh

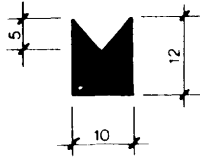

P 256 gr./mt. 130 60 Sh

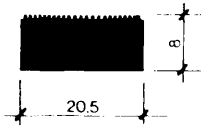

P 257 gr./mt. 205 60 Sh

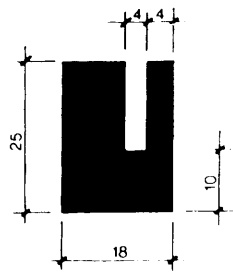

P 258 gr./mt. 510 50 Sh

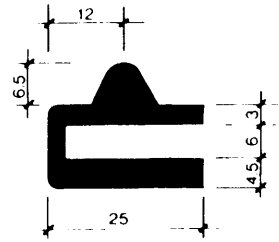

P 259 gr./mt. 340 60 Sh

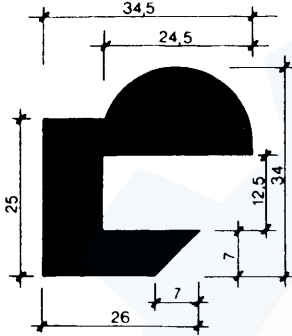

P 260 gr./mt. 740 60 Sh

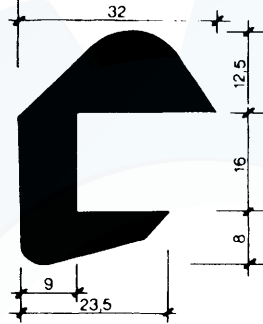

P 261 gr./mt. 640 60 Sh

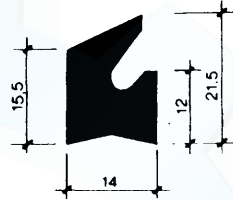

P 262 gr./mt. 265 70 Sh

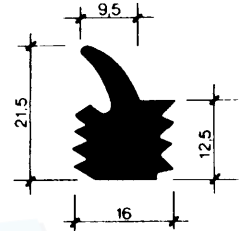

P 263 gr./mt. 310 60 Sh

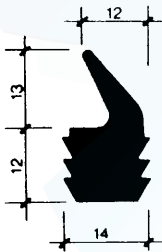

P 264 gr./mt. 261 70 Sh

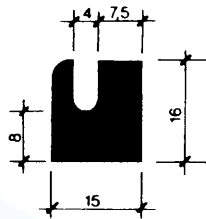

P 265 gr./mt. 285 60 Sh

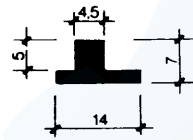

P 266 gr./mt. 57 50 Sh

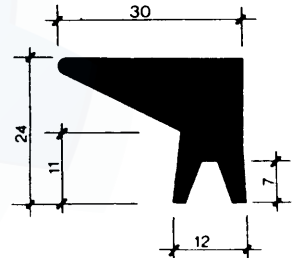

P 267 gr./mt. 480 60 Sh

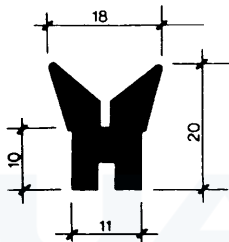

P 268 gr./mt. 290 Sh 60

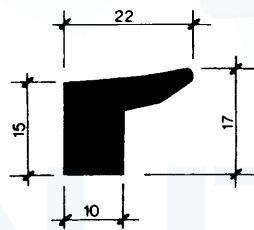

P 269 gr./mt. 270 Sh 60

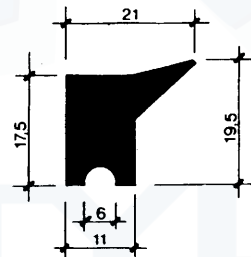

P 270 gr./mt. 310 Sh 60

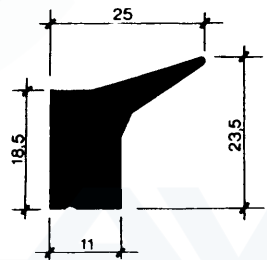

P 271 gr./mt. 307 Sh 60

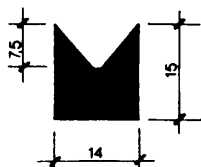

P 272 gr./mt. 230 60 Sh

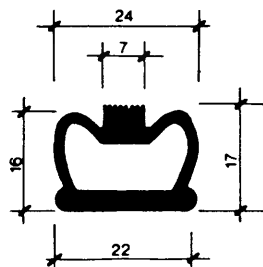

P 273 gr./mt. 220 60 Sh

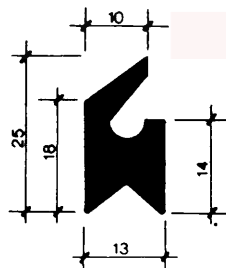

P 275 gr./mt. 273 70 Sh

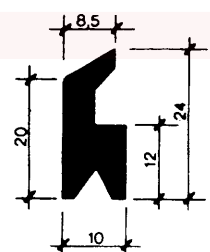

P 276 gr./mt. 205 70 Sh

ARTICOLI TECNICI IN GOMMA E SILICONE

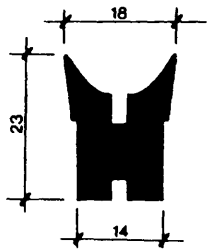

P 277 gr./mt. 380 60 Sh

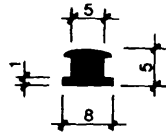

P 278 gr./mt. 33 60 Sh

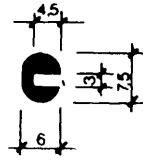

P 279 gr./mt. 35 60 Sh



P 280 gr./mt. 90 60 Sh

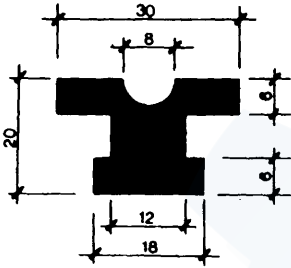

P 281 gr./mt. 460 60 Sh

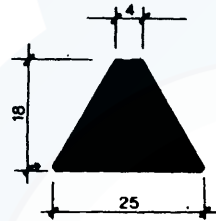

P 282 gr./mt. 310 60 Sh

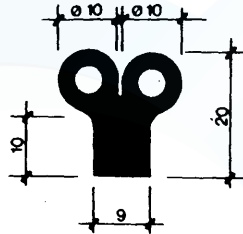

P 286 gr./mt. 250 50 Sh

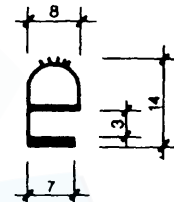

P 287 gr./mt. 54 60 Sh

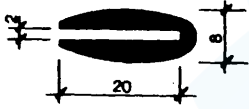

P 292 gr./mt. 195 60 Sh

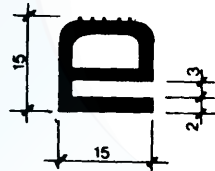

P 293 gr./mt. 156 60 Sh

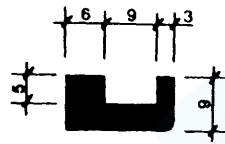

P 295 gr./mt. 155 60 Sh

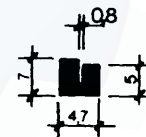

P 297 gr./mt. 32 60 Sh



P 298 gr./mt. 1000 50 Sh

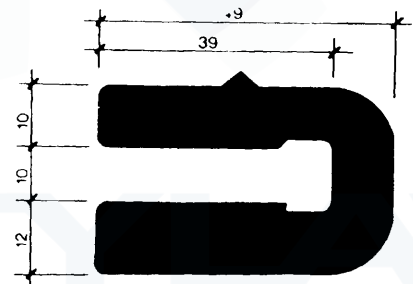

P 299 gr./mt. 1350 70 Sh

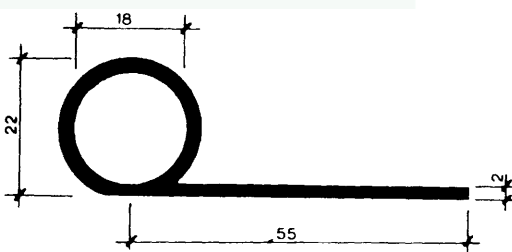

P 300 gr./mt. 228 60 Sh

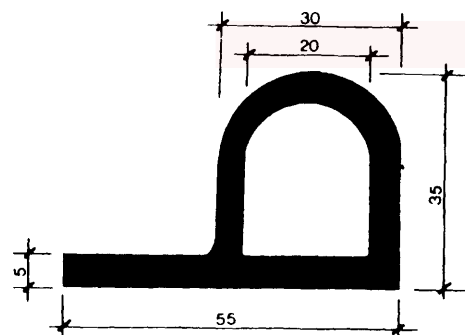

P 301 gr./mt. 820 60 Sh

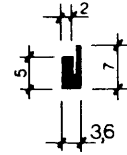
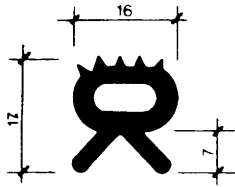

P 302 gr./mt. 160 60 Sh

P 303 gr./mt. 25 60 Sh

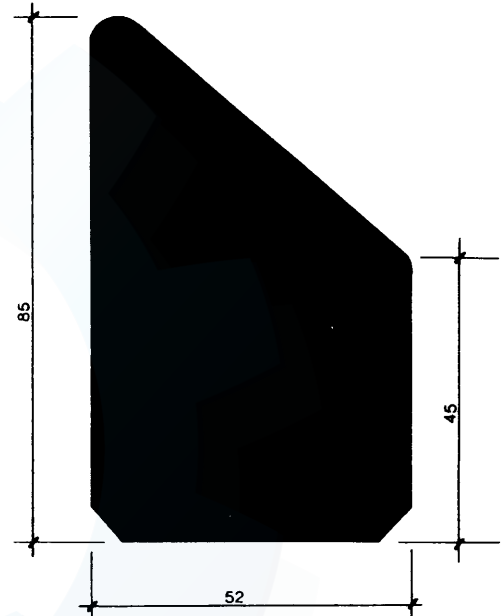
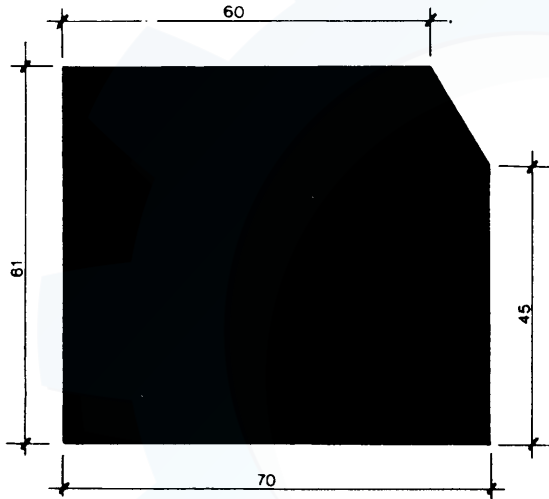

P 306 gr./mt. 5150 60 Sh

P 307 gr./mt. 4300 60 Sh

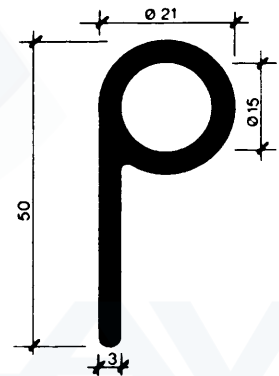
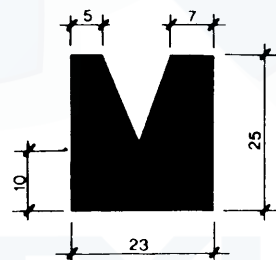
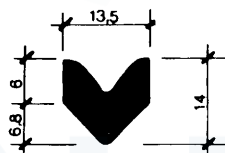
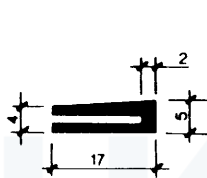

P 308 gr./mt. 80 60 Sh

P 312 gr./mt. 172 70 Sh

P 313 gr./mt. 490 60 Sh

P 314 gr./mt. 350 60 Sh

ARTICOLI TECNICI IN GOMMA E SILICONE

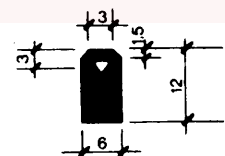
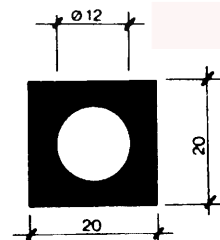
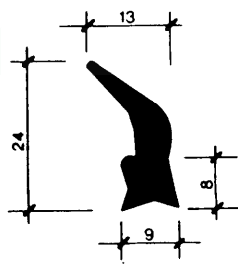
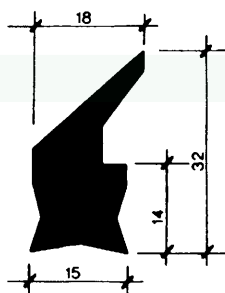

P 315 gr./mt. 400 70 Sh

P 316 gr./mt. 185 70 Sh

P 317 gr./mt. 360 50 Sh

P 318 gr./mt. 50 70 Sh

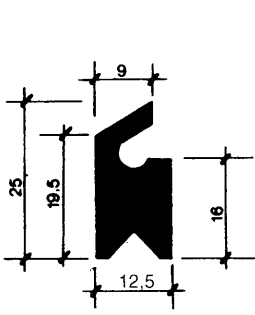

P 319 gr./mt. 290 70 Sh

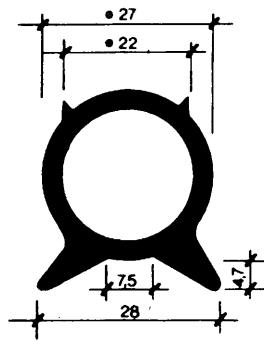

P 320 gr./mt. 436 70 Sh

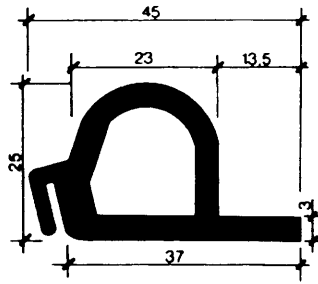

P 321 gr./mt. 530 70 Sh

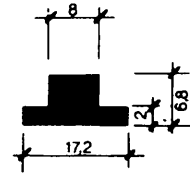

P 322 gr./mt. 100 60 Sh

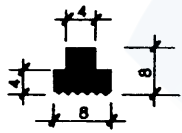

P 323 gr./mt. 60 60 Sh

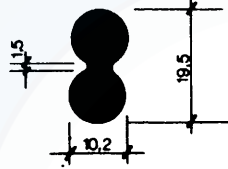

P 324 gr./mt. 237 60 Sh

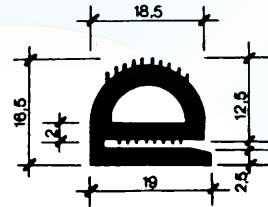

P 325 gr./mt. 175 70 Sh

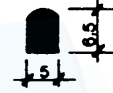

P 326 gr./mt. 40 60 Sh

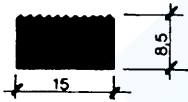

P 327 gr./mt. 160 60 Sh

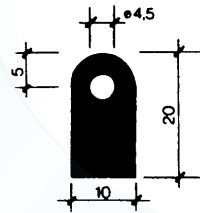

P 328 gr./mt. 210 50 Sh

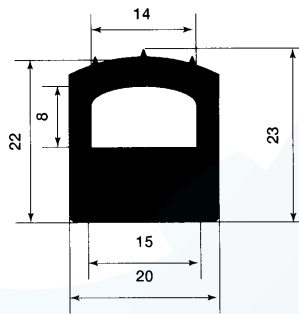

P 329 gr./mt. 408 60 Sh

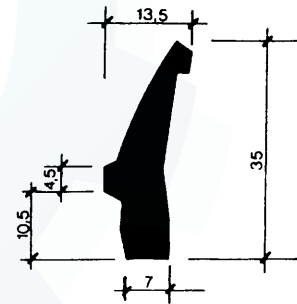

P 330 gr./mt. 335 70 Sh

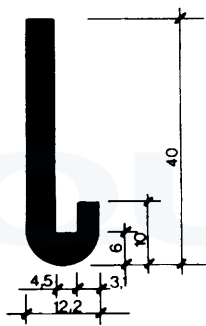

P 332 gr./mt. 260 70 Sh

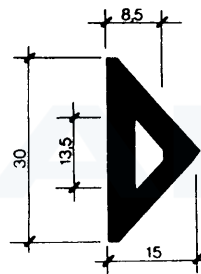

P 333 gr./mt. 230 50 Sh

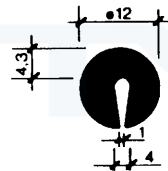

P 335 gr./mt. 126 70 Sh

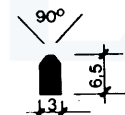

P 337 gr./mt. 20 60 Sh

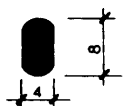

P 338 gr./mt. 40 50 Sh

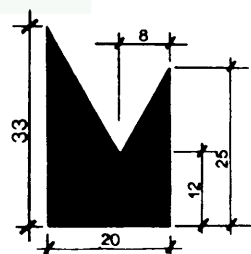

P 340 gr./mt. 540 70 Sh

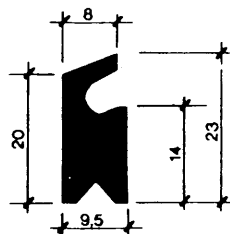

P 341 gr./mt. 230 60 Sh

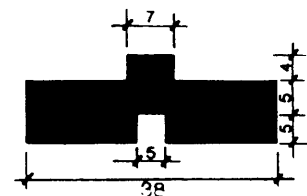

P 342 gr./mt. 515 60 Sh

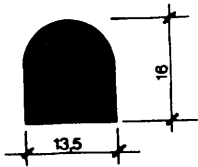

P 343 gr./mt. 240 60 Sh

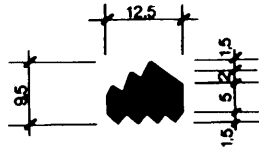

P 356 gr./mt. 98 60 Sh

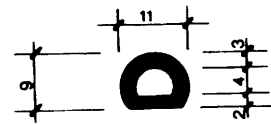

P 358 gr./mt. 40 50 Sh

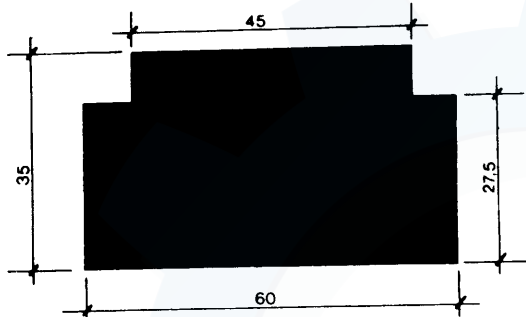

P 360 gr./mt. 2200 50 Sh

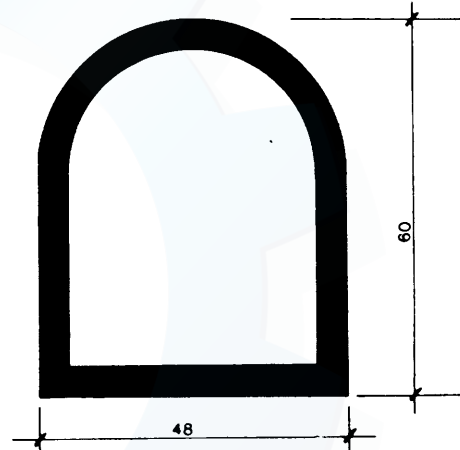

P 362 gr./mt. 1600 60 Sh
SP = 5

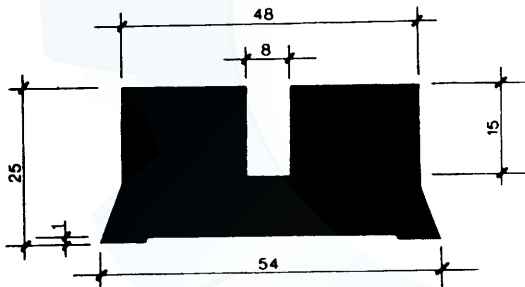

P 361 gr./mt. 1340 60 Sh

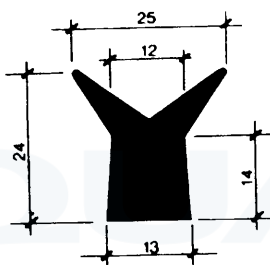

P 363 gr./mt. 370 70 Sh
SP = 2

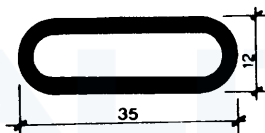

P 364 gr./mt. 260 70 Sh

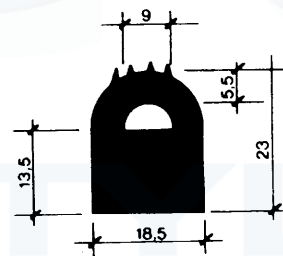

P 365 gr./mt. 485 70 Sh

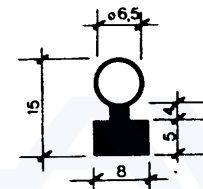

P 366 gr./mt. 95 60 Sh

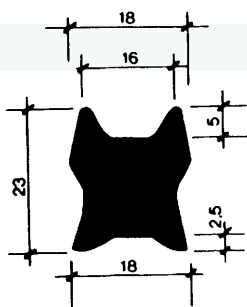

P 367 gr./mt. 460 70 Sh

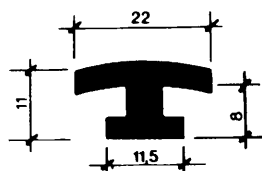

P 368 gr./mt. 185 60 Sh

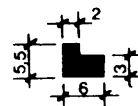

P 369 gr./mt. 28 70 Sh

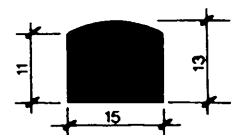

P 370 gr./mt. 212 50 Sh

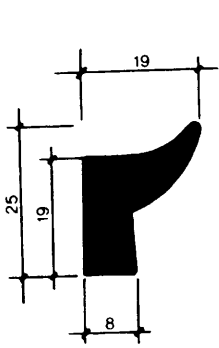

P 371 gr./mt. 250 50 Sh

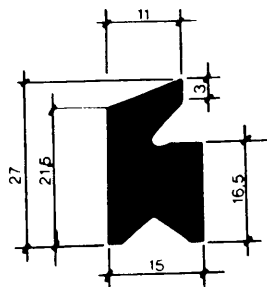

P 372 gr./mt. 340 70 Sh

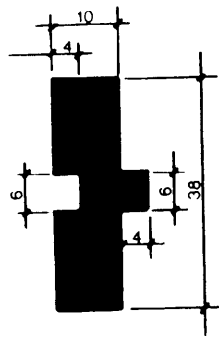

P 373 gr./mt. 515 60 Sh

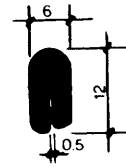

P 374 gr./mt. 80 50 Sh

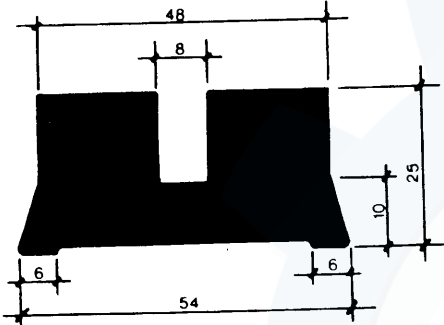

P 375 gr./mt. 1340 60 Sh

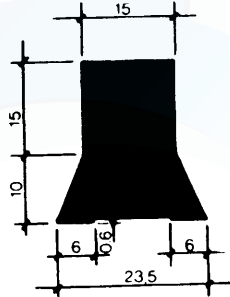

P 376 gr./mt. 480 50 Sh

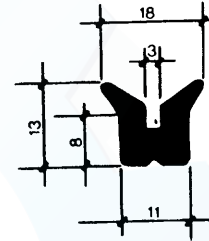

P 377 gr./mt. 137 60 Sh

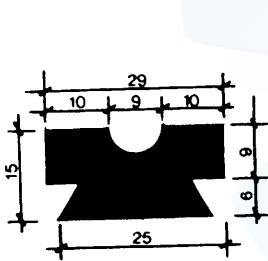

P 378 gr./mt. 480 60 Sh

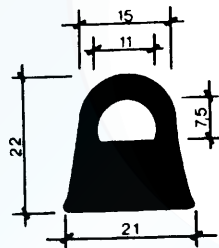

P 379 gr./mt. 336 30 Sh

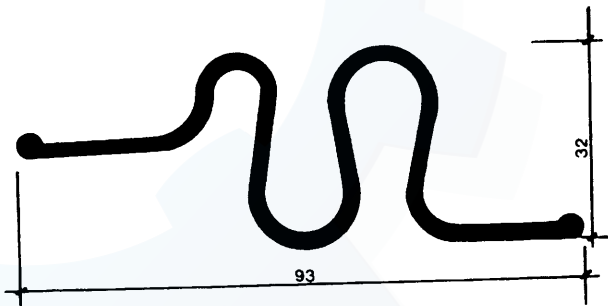

P 380 gr./mt. 815 60 Sh

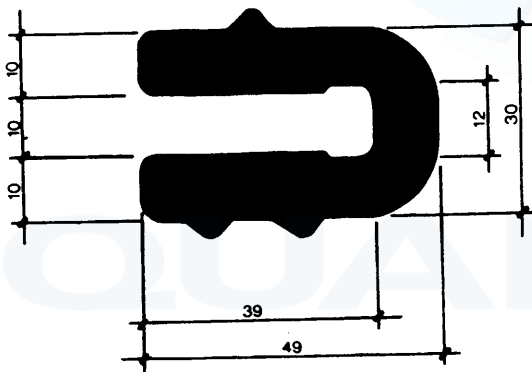

P 381 gr./mt. 1350 50 Sh

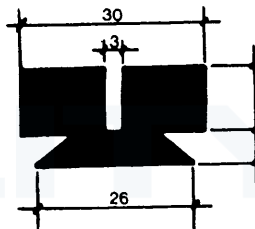

P 382 gr./mt. 490 60 Sh

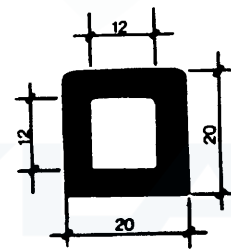

P 383 gr./mt. 335 60 Sh

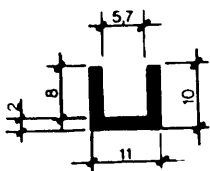

P 384 gr./mt. 65 50 Sh

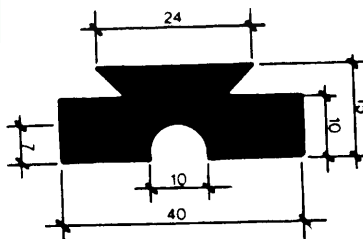

P 385 gr./mt. 560 60 Sh



P 386 gr./mt. 47 60 Sh

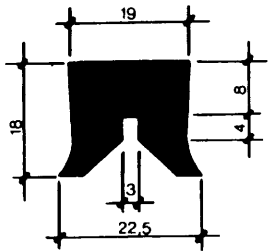

P 387 gr./mt. 330 60 Sh

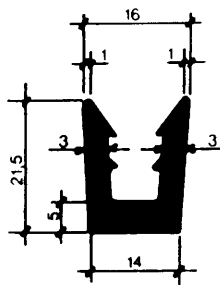

P 388 gr./mt. 200 60 Sh

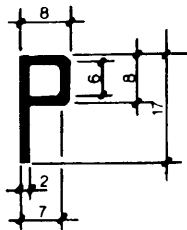

P 391 gr./mt. 72 70 Sh

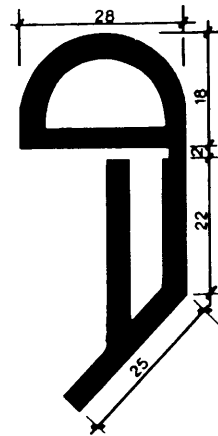

P 392 gr./mt. 430 60 Sh

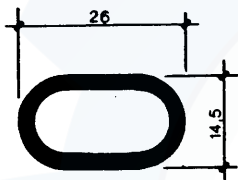

P 393 gr./mt. 265 70 Sh
SP = 2

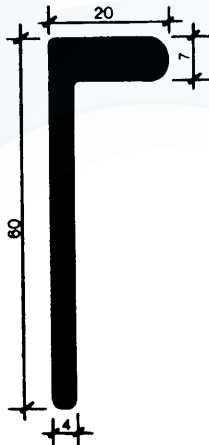

P 394 gr./mt. 460 50 Sh

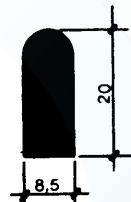

P 395 gr./mt. 201 60 Sh

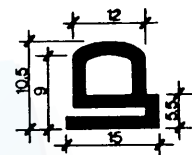

P 396 gr./mt. 100 60 Sh
SP = 1,5

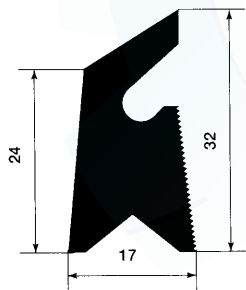

P 401 gr./mt. 390 60 Sh



P 402 gr./mt. 30 60 Sh

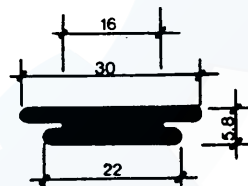

P 404 gr./mt. 170 70 Sh

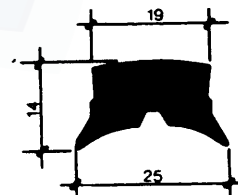

P 407 gr./mt. 233 60 Sh

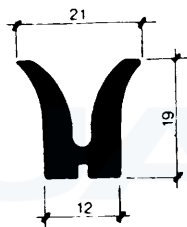

P 408 gr./mt. 190 60 Sh

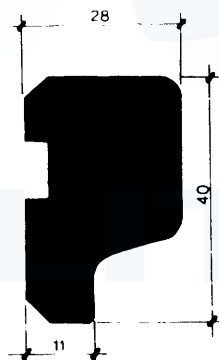

P 409 gr./mt. 1170 60 Sh

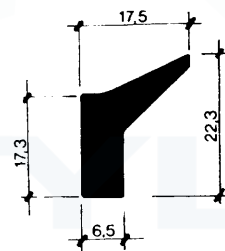

P 410 gr./mt. 210 50 Sh

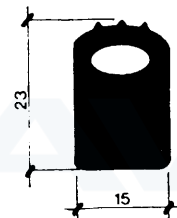

P 411 gr./mt. 355 60 Sh

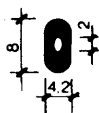

P 412 gr./mt. 37 50 Sh

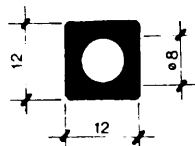

P 413 gr./mt. 130 60 Sh

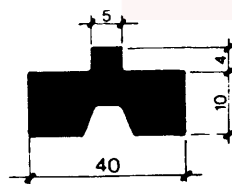

P 416 gr./mt. 515 60 Sh

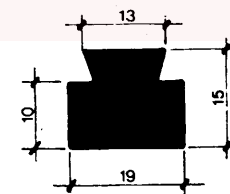

P 417 gr./mt. 325 60 Sh

ARTICOLI TECNICI IN GOMMA E SILICONE

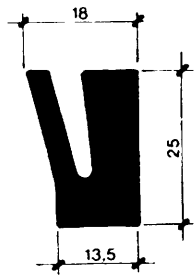

P 418 gr./mt. 417 70 Sh

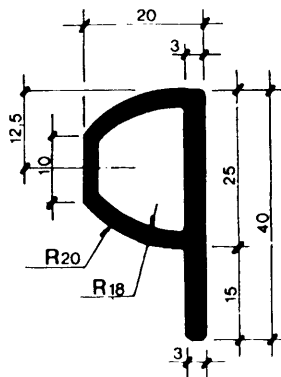

P 419 gr./mt. 290 60 Sh

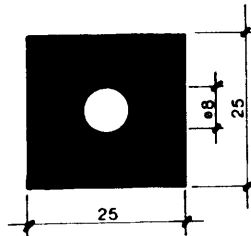

P 420 gr./mt. 875 60 Sh

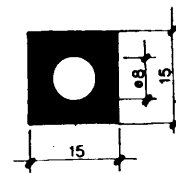

P 421 gr./mt. 245 50 Sh

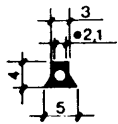

P 422 gr./mt. 13 50 Sh

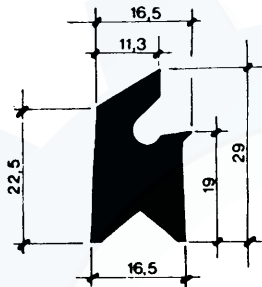

P 423 gr./mt. 370 70 Sh

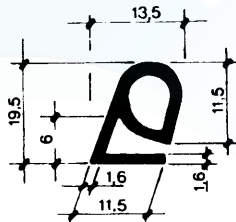

P 424 gr./mt. 93 60 Sh

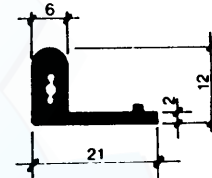

P 425 gr./mt. 140 60 Sh

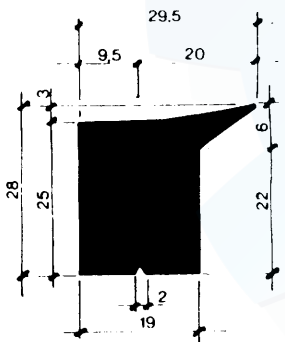

P 426 gr./mt. 790 70 Sh

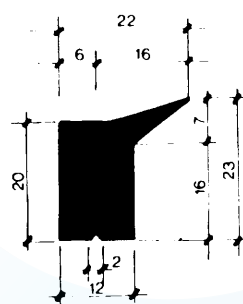

P 427 gr./mt. 390 70 Sh

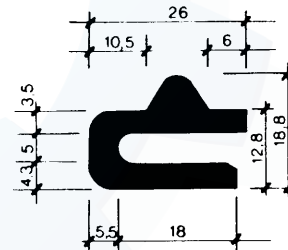

P 428 gr./mt. 350 60 Sh

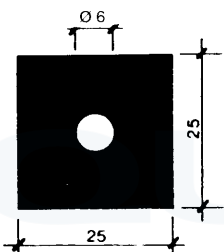

P 429 gr./mt. 915 70 Sh

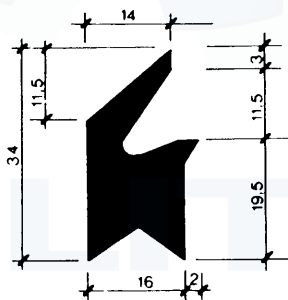

P 431 gr./mt. 530 70 Sh

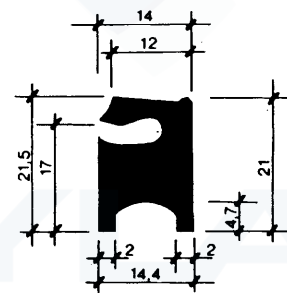

P 434 gr./mt. 296 60 Sh

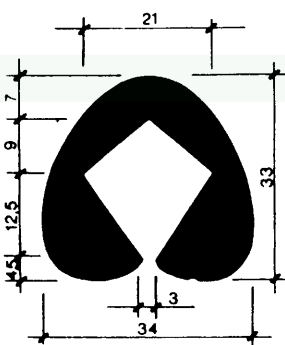

P 435 gr./mt. 885 50 Sh

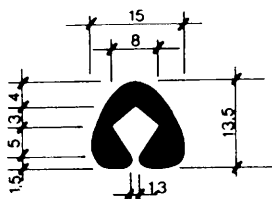

P 436 gr./mt. 142 50 Sh

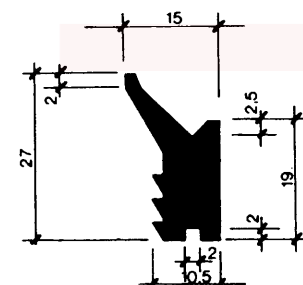

P 437 gr./mt. 260 70 Sh

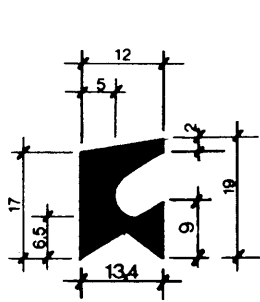

P 441 gr./mt. 206 60 Sh

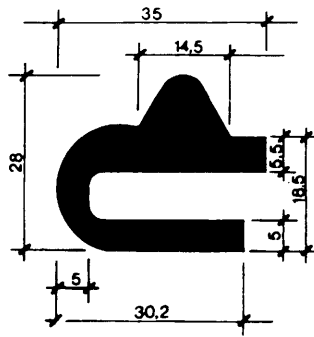

P 442 gr./mt. 594 60 Sh

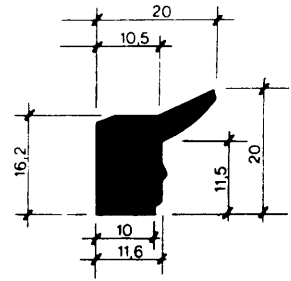

P 443 gr./mt. 281 60 Sh

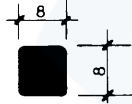

P 444 gr./mt. 80 50 Sh

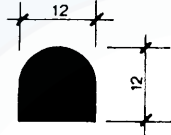

P 445 gr./mt. 170 60 Sh

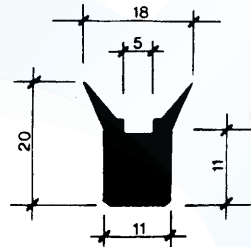

P 446 gr./mt. 220 60 Sh

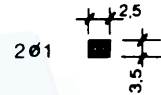

P 448 gr./mt. 7 50 Sh

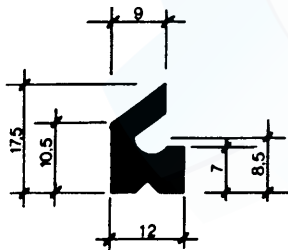

P 449 gr./mt. 145 60 Sh

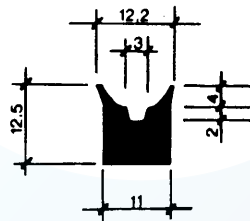

P 450 gr./mt. 137 60 Sh

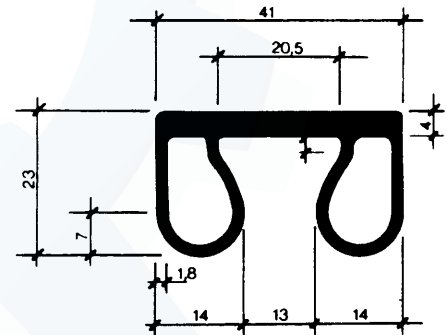

P 452 gr./mt. 370 70 Sh

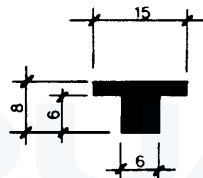

P 453 gr./mt. 90 60 Sh

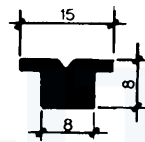

P 454 gr./mt. 96 60 Sh

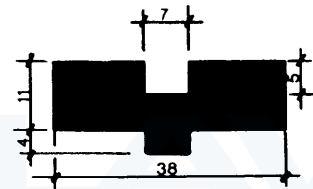

P 455 gr./mt. 540 50 Sh

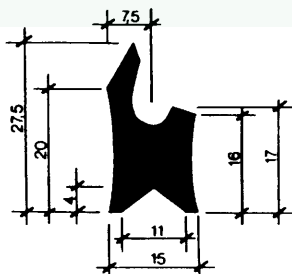

P 458 gr./mt. 316 60 Sh

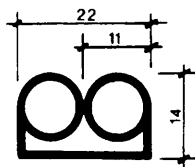

P 459 gr./mt. 120 50 Sh
SP = 1

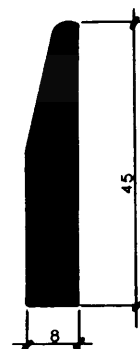

P 460 gr./mt. 410 60 Sh

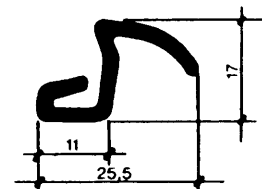

P 461 gr./mt. 130 70 Sh

QUALITY
ARTICOLI TECNICI IN GOMMA E SILICONE

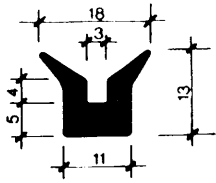

P 462 gr./mt. 150 50 Sh

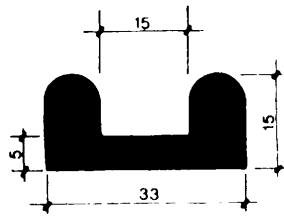

P 463 gr./mt. 430 60 Sh

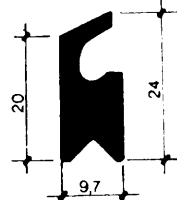

P 464 gr./mt. 200 60 Sh

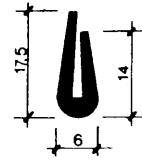

P 465 gr./mt. 74 60 Sh

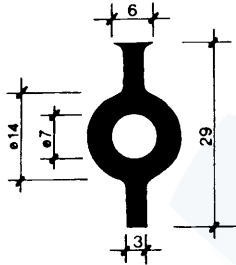

P 466 gr./mt. 255 60 Sh

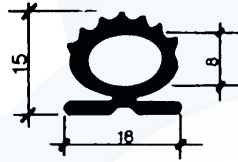

P 467 gr./mt. 165 60 Sh

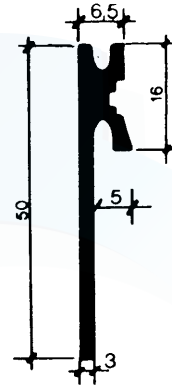

P 468 gr./mt. 235 60 Sh

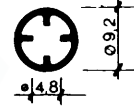

P 469 gr./mt. 42 60 Sh
SP = 0,7

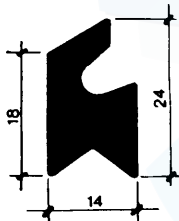

P 471 gr./mt. 310 70 Sh

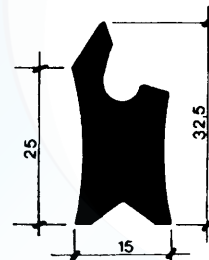

P 474 gr./mt. 395 60 Sh

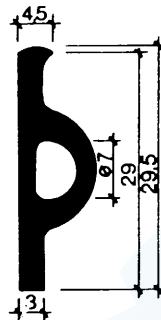

P 477 gr./mt. 200 60 Sh



P 478 gr./mt. 100 60 Sh

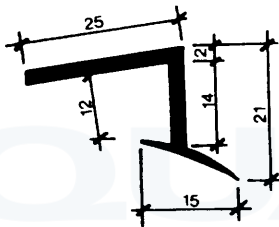

P 479 gr./mt. 95 60 Sh

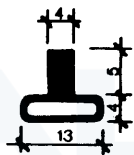

P 480 gr./mt. 70 60 Sh

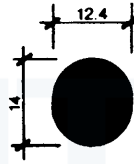

P 483 gr./mt. 190 70 Sh

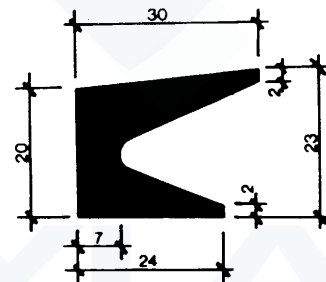

P 484 gr./mt. 475 70 Sh

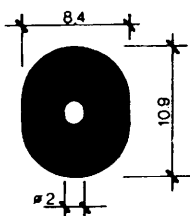

P 486 gr./mt. 100 70 Sh

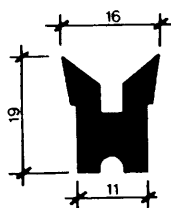

P 487 gr./mt. 220 60 Sh

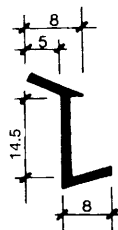

P 488 gr./mt. 32 60 Sh

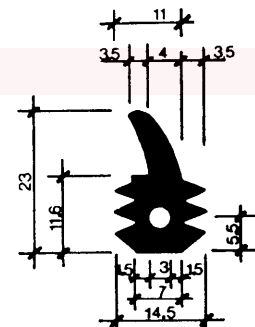

P 489 gr./mt. 209 70 Sh

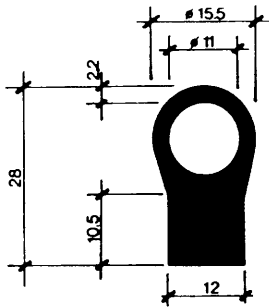

P 491 gr./mt. 325 60 Sh

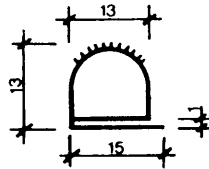

P 492 gr./mt. 140 50 Sh
SP = 1,5

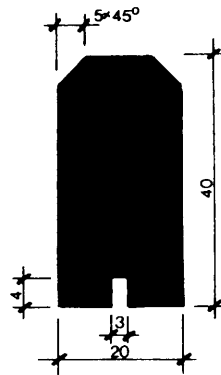

P 493 gr./mt. 1060 60 Sh

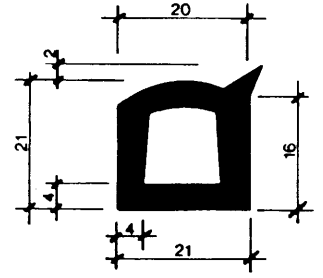

P 495 gr./mt. 360 50 Sh

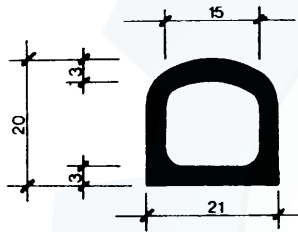

P 496 gr./mt. 234 70 Sh

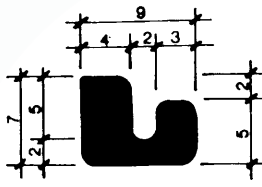

P 497 gr./mt. 63 60 Sh

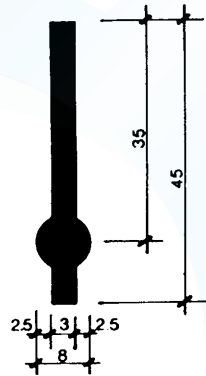

P 499 gr./mt. 200 60 Sh

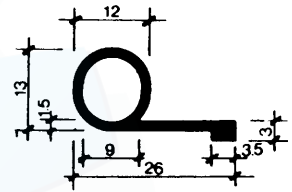

P 500 gr./mt. 115 60 Sh

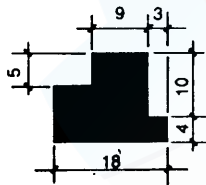

P 501 gr./mt. 270 60 Sh

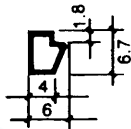

P 502 gr./mt. 20 70 Sh
SP = 0,8



P 503 gr./mt. 54 70 Sh

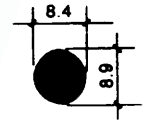

P 504 gr./mt. 83 80 Sh

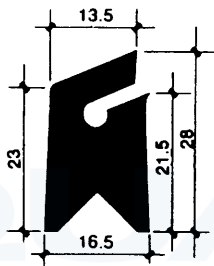

P 505 gr./mt. 370 70 Sh

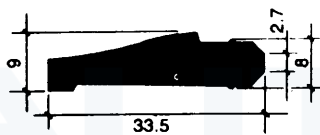

P 506 gr./mt. 265 60 Sh



P 507 gr./mt. 80 80 Sh

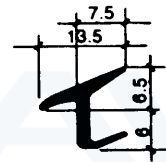

P 508 gr./mt. 50 70 Sh

ARTICOLI TECNICI IN GOMMA E SILICONE

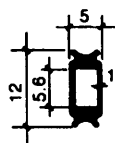

P 509 gr./mt. 40 50 Sh

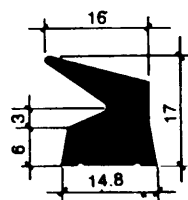

P 510 gr./mt. 214 70 Sh

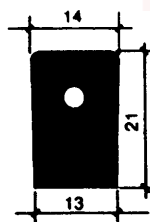

P 511 gr./mt. 280 50 Sh

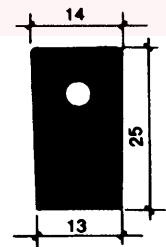

P 512 gr./mt. 340 40 Sh

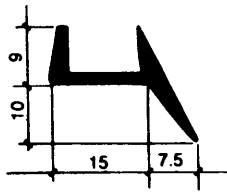

P 513 gr./mt. 110 60 Sh

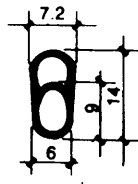

P 514 gr./mt. 45 60 Sh

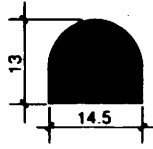

P 515 gr./mt. 217 60 Sh

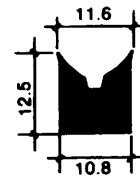

P 516 gr./mt. 117 60 Sh

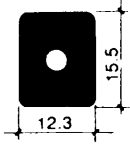

FORI Ø3 Ø4 15

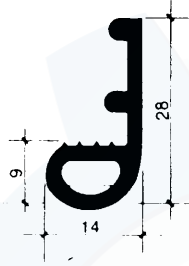

P 517 gr./mt. 220 70 Sh



P 519 gr./mt. 320 60 Sh

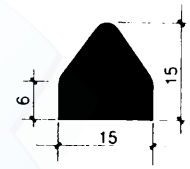

P 520 gr./mt. 194 50 Sh

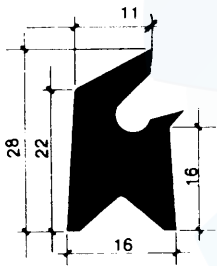

P 521 gr./mt. 390 60 Sh

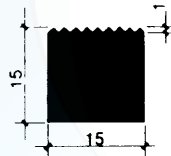

9 RIGHETTATURE

P 522 gr./mt. 275 60 Sh

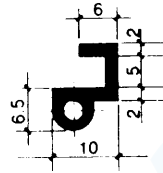

P 523 gr./mt. 78 60 Sh

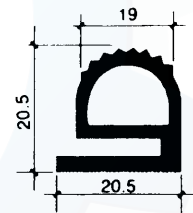

8 RIGHETTATURE

P 524 gr./mt. 210 60 Sh

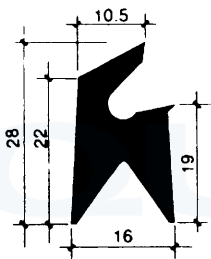

P 525 gr./mt. 342 60 Sh

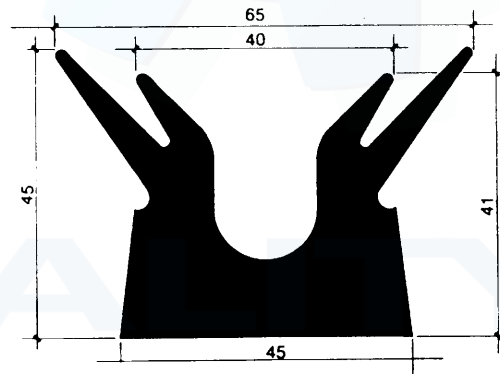

P 526 gr./mt. 1900 70 Sh

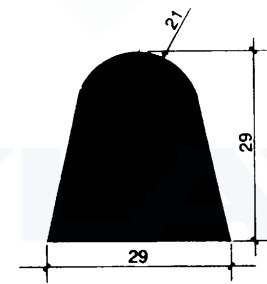

P 527 gr./mt. 840 60 Sh

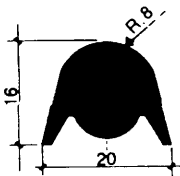

P 528 gr./mt. 250 40 Sh

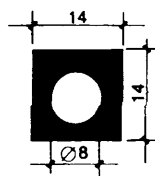

P 529 gr./mt. 165 60 Sh

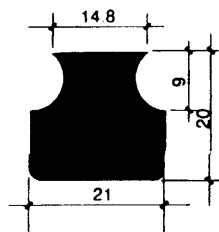

P 530 gr./mt. 430 60 Sh

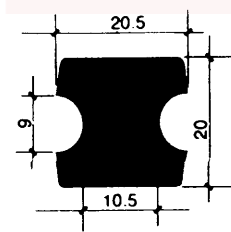

P 531 gr./mt. 410 60 Sh

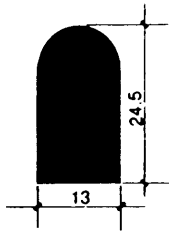

P 532 gr./mt. 350 50 Sh

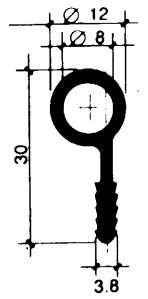

P 533 gr./mt. 145 60 Sh

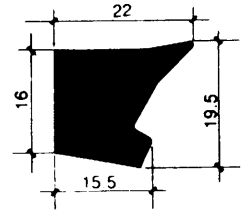

P 534 gr./mt. 360 70 Sh

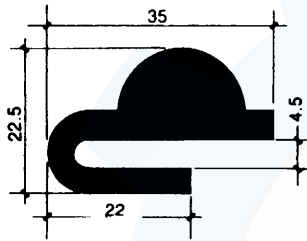

P 535 gr./mt. 450 Sh 50

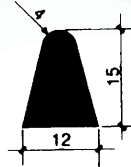

P 536 gr./mt. 185 Sh 60

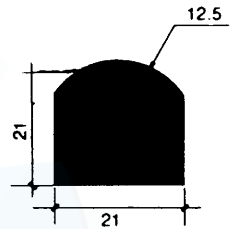

P 537 gr./mt. 480 Sh 60

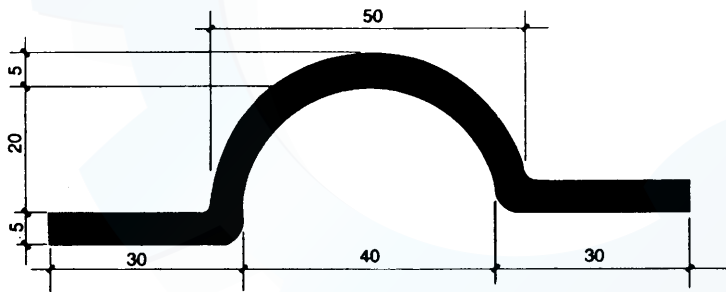

P 538 gr./mt. 900 60 Sh

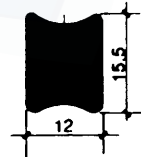

P 539 gr./mt. 235 60 Sh

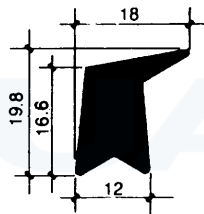

P 540 gr./mt. 300 60 Sh

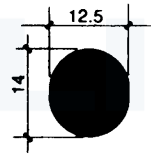

P 541 gr./mt. 240 50 Sh

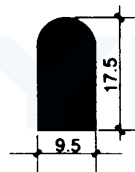

P 542 gr./mt. 200 70 Sh

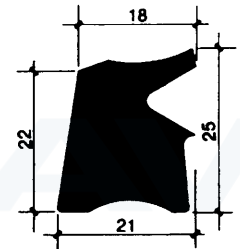

P 543 gr./mt. 517 60 Sh

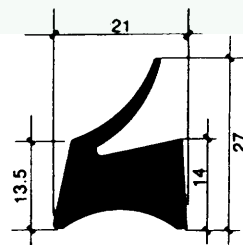

P 544 gr./mt. 400 60 Sh

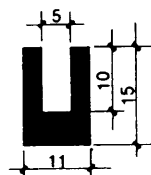

P 545 gr./mt. 145 70 Sh

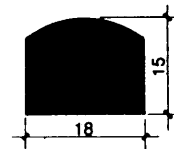

P 546 gr./mt. 300 60 Sh

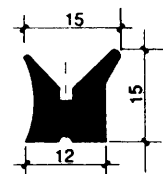

P 547 gr./mt. 185 70 Sh

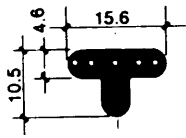

N. 5 FORI Ø 1 mm

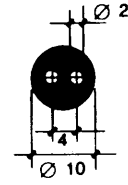
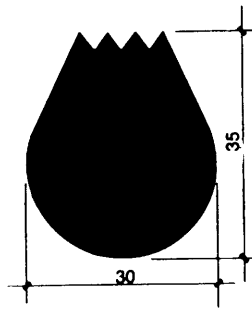

P 548 gr./mt. 120 60 Sh

P 549 gr./mt. 75 50 Sh

P 550 gr./mt. 970 50 Sh

P 551 gr./mt. 90 70 Sh

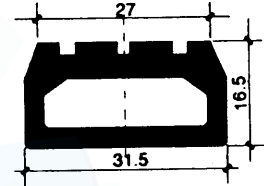
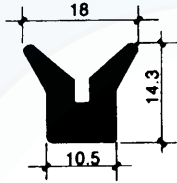
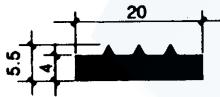

P 552 gr./mt. 100 50 Sh

P 553 gr./mt. 160 60 Sh

P 554 gr./mt. 80 70 Sh

P 555 gr./mt. 385 50 Sh

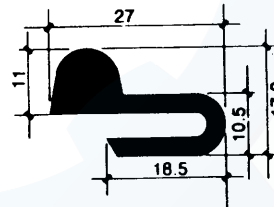
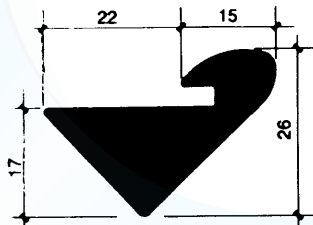
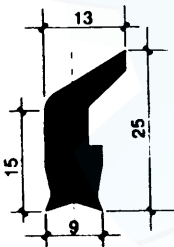

P 556 gr./mt. 220 60 Sh

P 557 gr./mt. 542 60 Sh

P 558 gr./mt. 300 50 Sh

P 559 gr./mt. 3 60 Sh

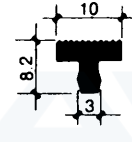
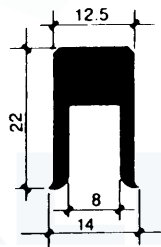
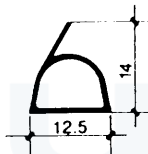

P 560 gr./mt. 43 60 Sh

P 561 gr./mt. 220 60 Sh

P 562 gr./mt. 42 60 Sh

P 563 gr./mt. 56 60 Sh

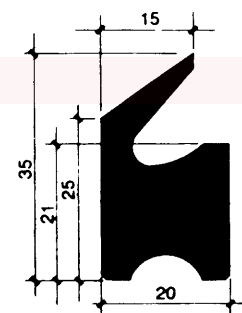
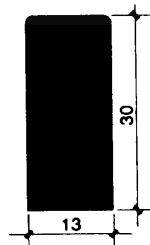
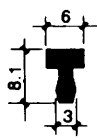
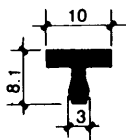

P 564 gr./mt. 57 65 Sh

P 565 gr./mt. 41 65 Sh

P 566 gr./mt. 460 50 Sh

P 567 gr./mt. 580 60 Sh

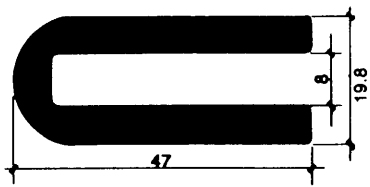

P 568 gr./mt. 670 60 Sh

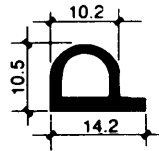

P 569 gr./mt. 78 60 Sh

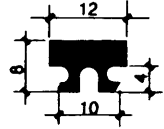

P 570 gr./mt. 90 60 Sh

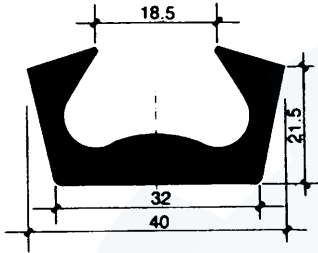

P 571 gr./mt. 670 60 Sh

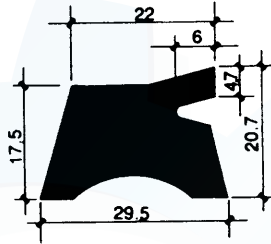

P 572 gr./mt. 660 70 Sh

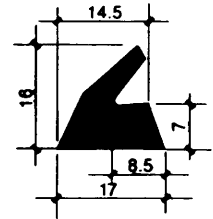

P 573 gr./mt. 205 70 Sh

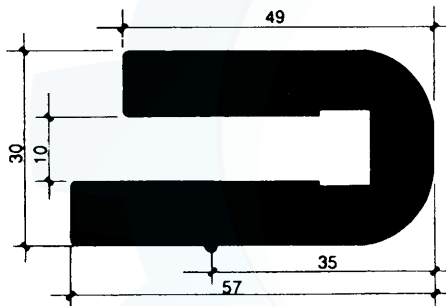

P 574 gr./mt. 1355 50 Sh

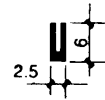

P 575 gr./mt. 15 60 Sh
SP = 1

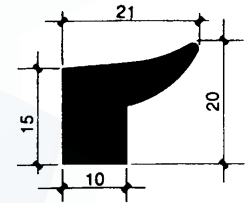

P 576 gr./mt. 270 60 Sh

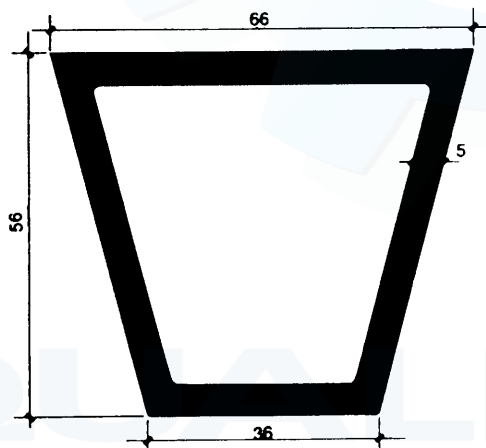

P 577 gr./mt. 1180 60 Sh

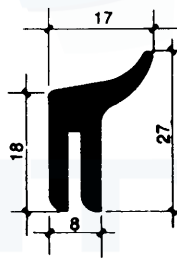

P 578 gr./mt. 203 60 Sh

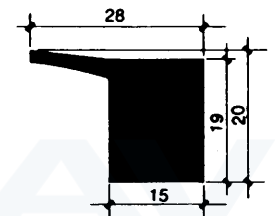

P 579 gr./mt. 420 60 Sh

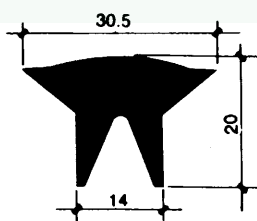

P 580 gr./mt. 345 60 Sh

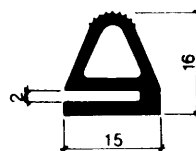

P 581 gr./mt. 106 50 Sh

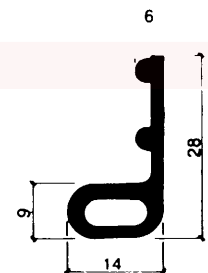

P 582 gr./mt. 160 60 Sh

ARTICOLI TECNICI IN GOMMA E SILICONE

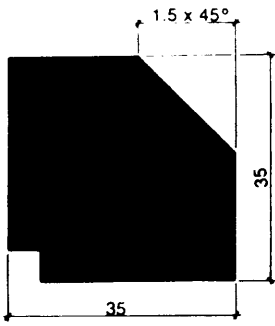

P 583 gr./mt. 1380 60 Sh

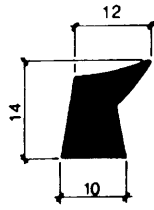

P 584 gr./mt. 170 60 Sh

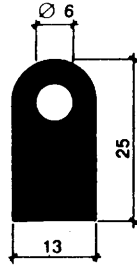

P 585 gr./mt. 320 50 Sh

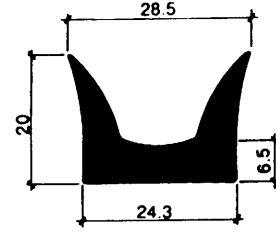

P 586 gr./mt. 345 70 Sh

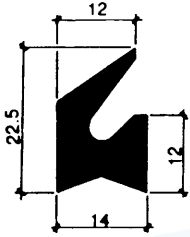

P 587 gr./mt. 240 50 Sh

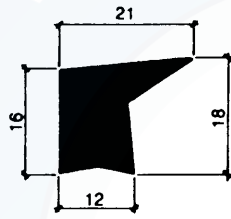

P 588 gr./mt. 270 60 Sh



P 589 gr./mt. 11 60 Sh

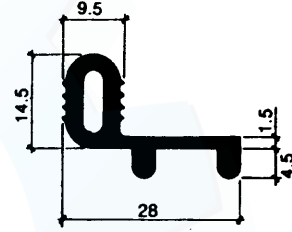

P 590 gr./mt. 200 60 Sh

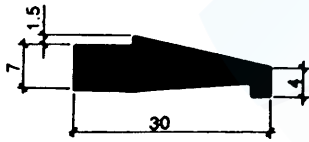

P 591 gr./mt. 240 70 Sh

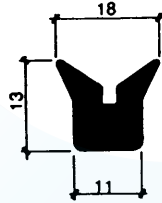

P 592 gr./mt. 150 50 Sh

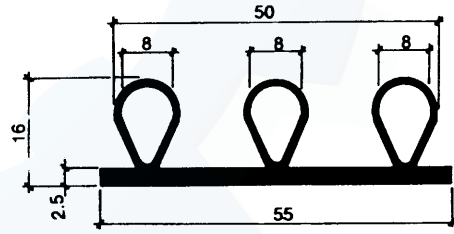

P 593 gr./mt. 436 60 Sh

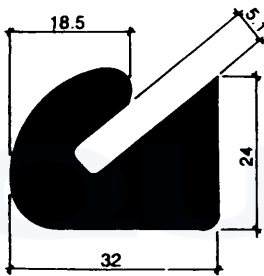

P 594 gr./mt. 778 60 Sh

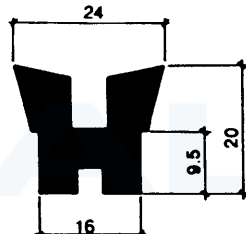

P 595 gr./mt. 371 60 Sh

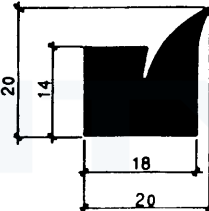

P 596 gr./mt. 345 70 Sh

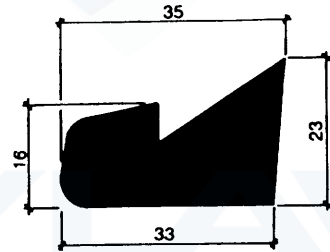

P 597 gr./mt. 880 60 Sh

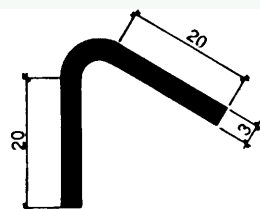

P 598 gr./mt. 180 60 Sh

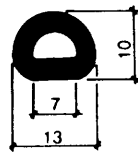

P 599 gr./mt. 120 60 Sh

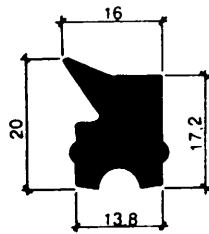

P 600 gr./mt. 275 60 Sh

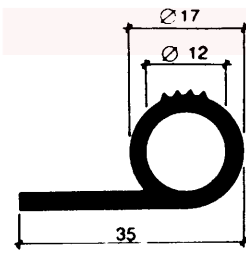

P 601 gr./mt. 204 60 Sh

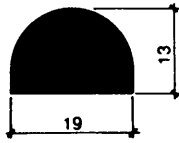

P 602 gr./mt. 250 60 Sh

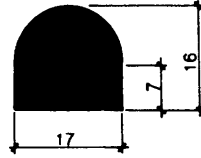

P 603 gr./mt. 307 60 Sh

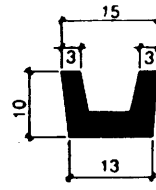

P 604 gr./mt. 127 60 Sh

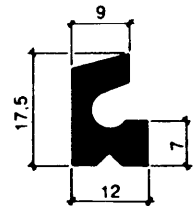

P 605 gr./mt. 165 60 Sh

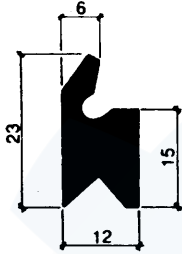

P 606 gr./mt. 215 60 Sh

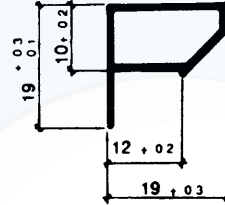

P 607 gr./mt. 67 70 Sh

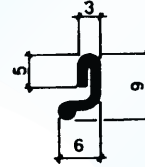

P 608 gr./mt. 21 50 Sh

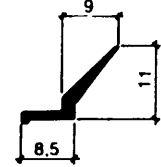

P 609 gr./mt. 38 70 Sh

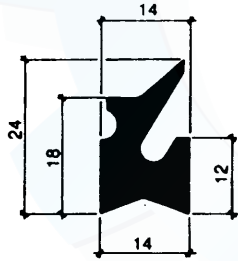

P 610 gr./mt. 241 50 Sh

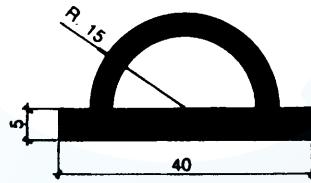

P 611 gr./mt. 445 60 Sh

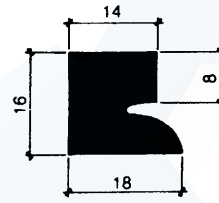

P 612 gr./mt. 320 70 Sh

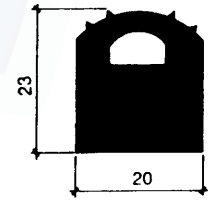

P 613 gr./mt. 490 70 Sh

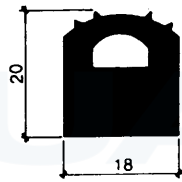

P 614 gr./mt. 363 70 Sh

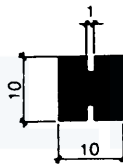

P 615 gr./mt. 127 60 Sh

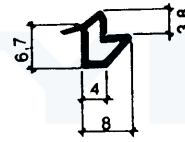

P 616 gr./mt. 30 70 Sh



P 617 gr./mt. 190 60 Sh



P 618 gr./mt. 34 60 Sh

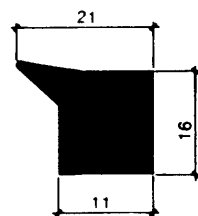

P 619 gr./mt. 270 60 Sh

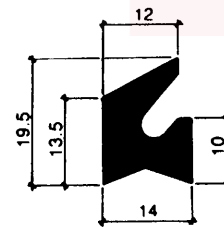

P 620 gr./mt. 223 60 Sh

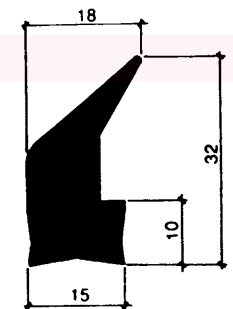

P 621 gr./mt. 380 70 Sh

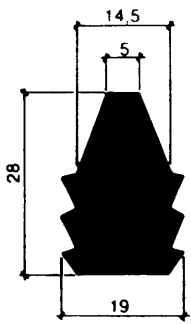

P 622 gr./mt. 450 70 Sh

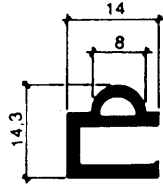

P 623 gr./mt. 100 50 Sh

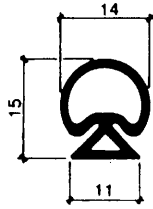

P 624 gr./mt. 83 60 Sh

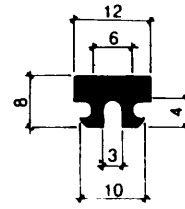

P 625 gr./mt. 87 50 Sh

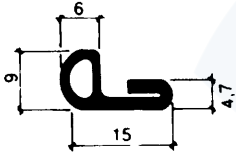

P 626 gr./mt. 72 60 Sh



P 627 gr./mt. 117 60 Sh

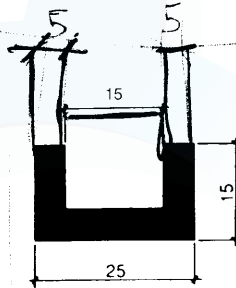

P 628 gr./mt. 295 60 Sh

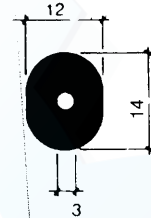

P 629 gr./mt. 190 70 Sh

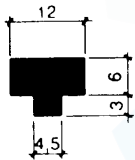

P 630 gr./mt. 103 71 Sh

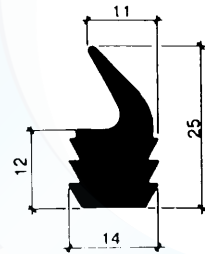

P 631 gr./mt. 246 70 Sh

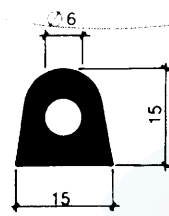

P 632 gr./mt. 185 60 Sh



P 633 gr./mt. 175 70 Sh

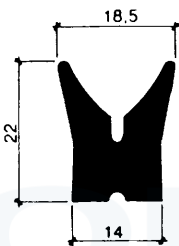

P 634 gr./mt. 265 60 Sh

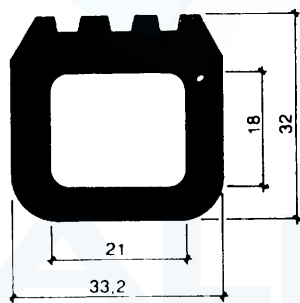

P 635 gr./mt. 788 50 Sh

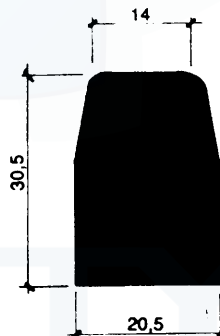

P 636 gr./mt. 740 60 Sh



P 637 gr./mt. 374 70 Sh

ARTICOLI TECNICI IN GOMMA E SILICONE

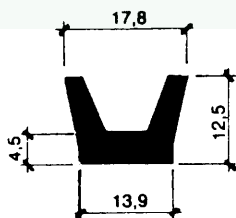

P 638 gr./mt. 150 60 Sh

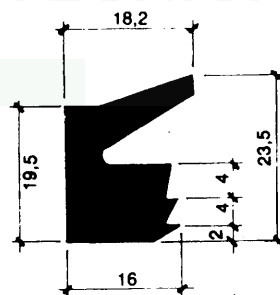

P 639 gr./mt. 336 60 Sh

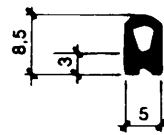

P 640 gr./mt. 40 50 Sh

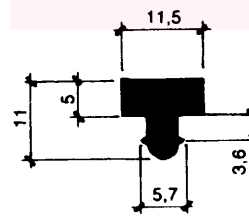

P 641 gr./mt. 100 50 Sh

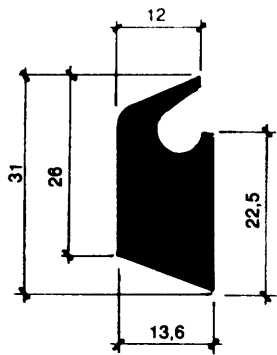

P 642 gr./mt. 450 60 Sh

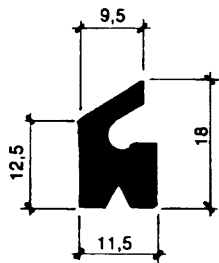

P 643 gr./mt. 166 70 Sh

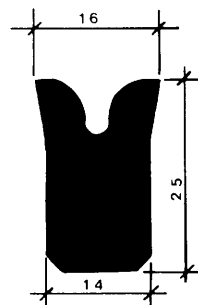

P 644 gr./mt. 405 60 Sh

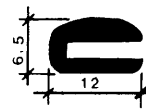

P 645 gr./mt. 66 50 Sh

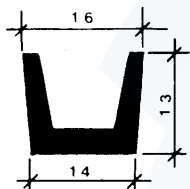

P 646 gr./mt. 133 60 Sh

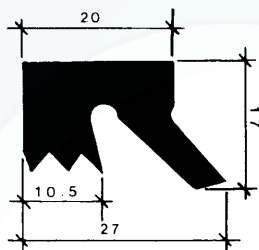

P 647 gr./mt. 340 60 Sh

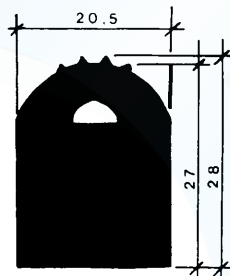

P 648 gr./mt. 568 60 Sh

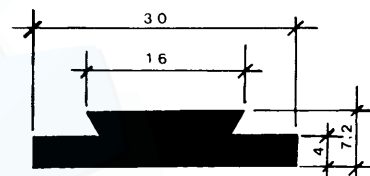

P 649 gr./mt. 190 60 Sh

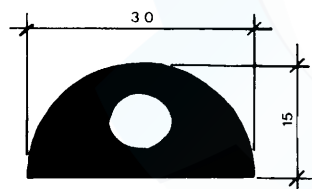

P 650 gr./mt. 390 50 Sh

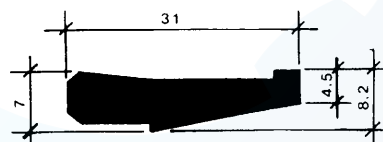

P 651 gr./mt. 235 60 Sh

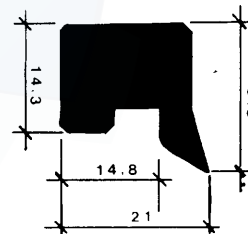

P 652 gr./mt. 302 60 Sh

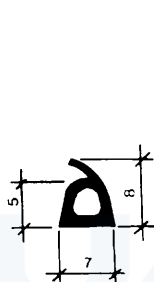

P 653 gr./mt. 30 50 Sh

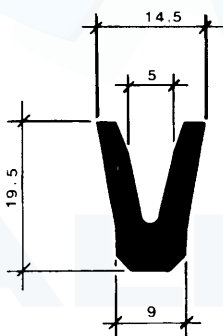

P 654 gr./mt. 210 70 Sh

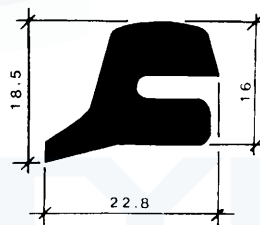

P 655 gr./mt. 275 70 Sh

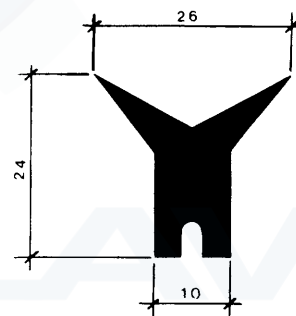

P 656 gr./mt. 330 70 Sh

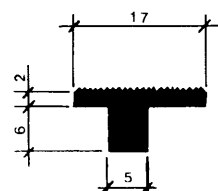

P 657 gr./mt. 84 50 Sh

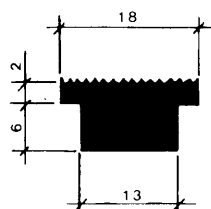

P 658 gr./mt. 147 50 Sh

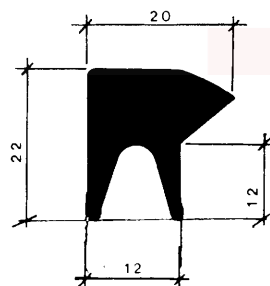

P 659 gr./mt. 320 60 Sh

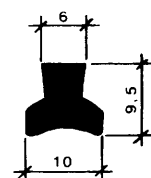

P 660 gr./mt. 90 70 Sh

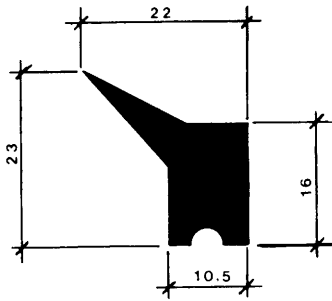

P 661 gr./mt. 260 70 Sh

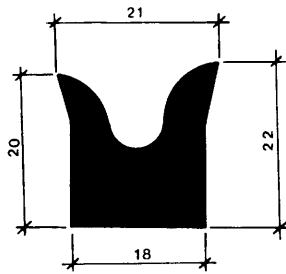

P 662 gr./mt. 327 70 Sh

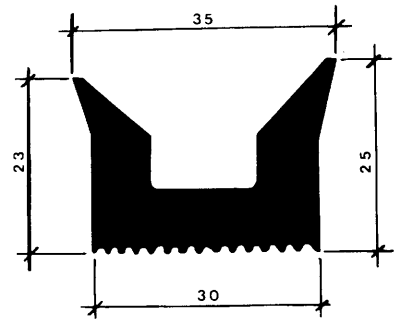

P 663 gr./mt. 550 60 Sh

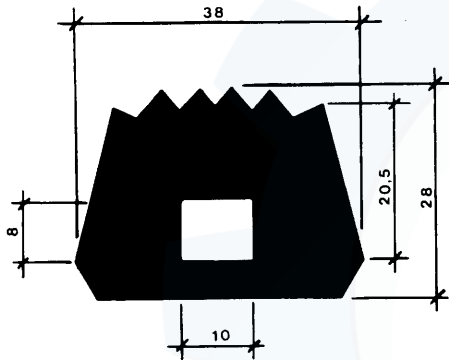

P 664 gr./mt. 900 60 Sh

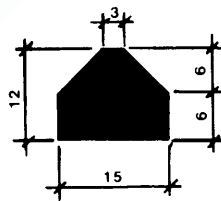

P 665 gr./mt. 190 60 Sh

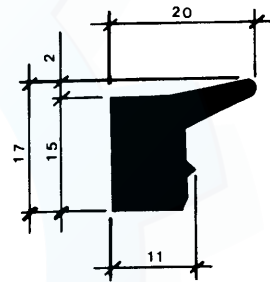

P 667 gr./mt. 240 70 Sh

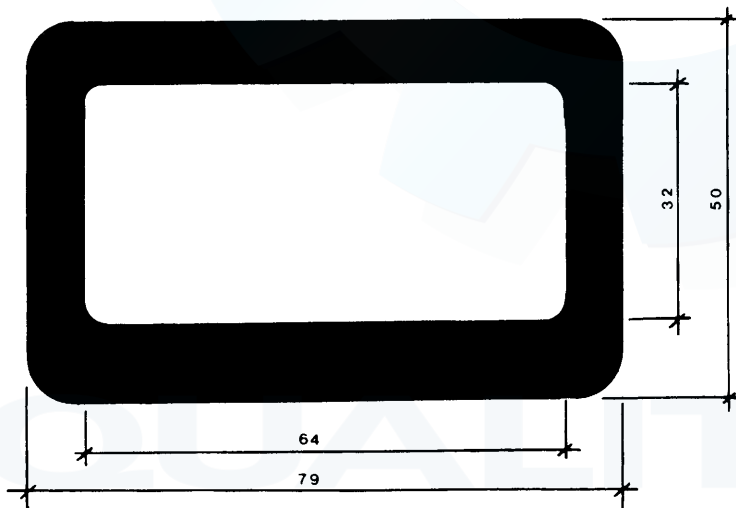

P 666 gr./mt. 2700 60 Sh

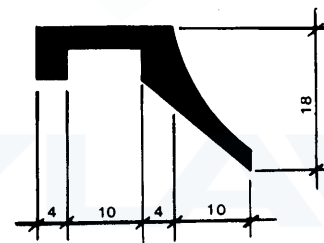

P 668 gr./mt. 180 50 Sh

ARTICOLI TECNICI IN GOMMA E SILICONE

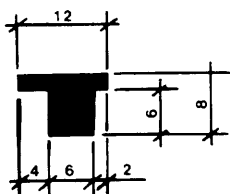

P 669 gr./mt. 76 70 Sh

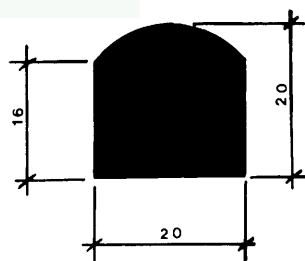

P 670 gr./mt. 520 50 Sh

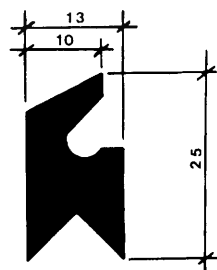

P 671 gr./mt. 250 60 Sh

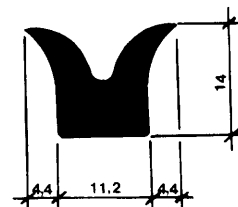

P 672 gr./mt. 185 70 Sh

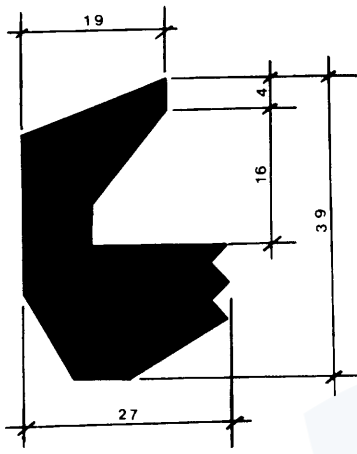

P 673 gr./mt. 780 60 Sh

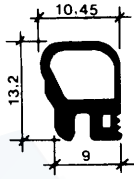

P 674 gr./mt. 80 50 Sh

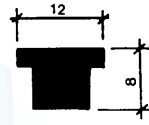

P 675 gr./mt. 92 70 Sh

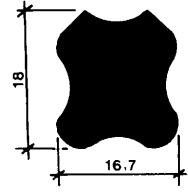

P 676 gr./mt. 320 70 Sh

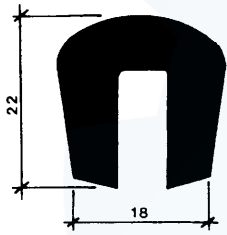

P 677 gr./mt. 385 70 Sh

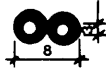

P 678 gr./mt. 24 70 Sh

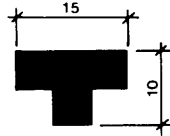

P 679 gr./mt. 127 60 Sh

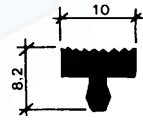

P 680 gr./mt. 55 60 Sh

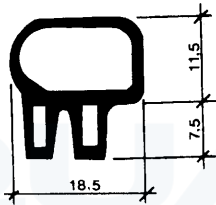

P 681 gr./mt. 160 60 Sh



P 682 gr./mt. 12 60 Sh

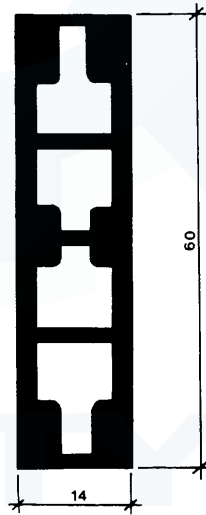

P 683 gr./mt. 150 60 Sh

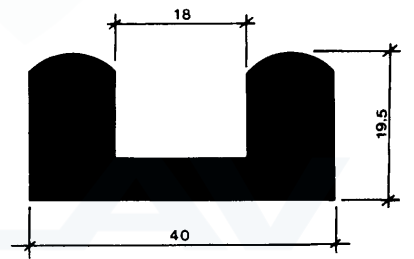

P 684 gr./mt. 580 60 Sh

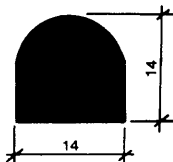

P 685 gr./mt. 218 60 Sh

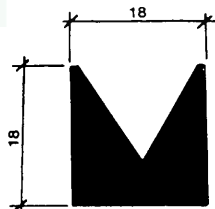

P 686 gr./mt. 270 60 Sh

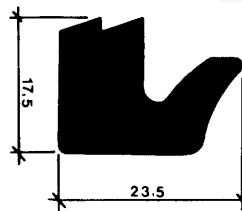

P 687 gr./mt. 360 70 Sh

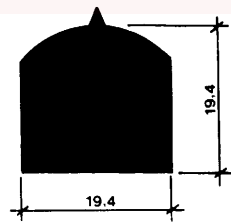

P 688 gr./mt. 435 50 Sh

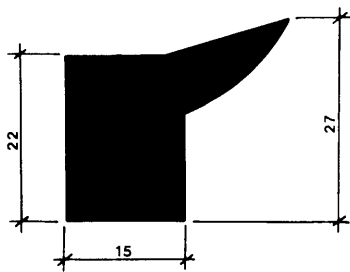

P 689 gr./mt. 532 60 Sh

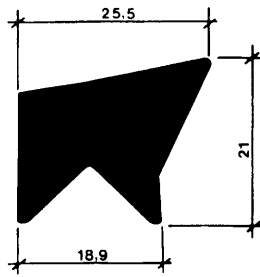

P 690 gr./mt. 405 60 Sh

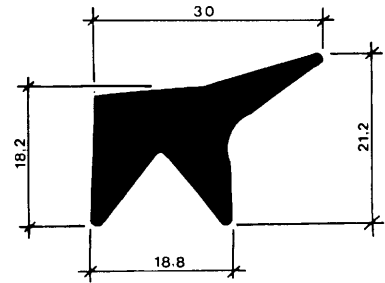

P 691 gr./mt. 390 60 Sh

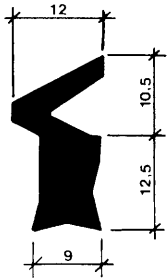

P 692 gr./mt. 175 50 Sh

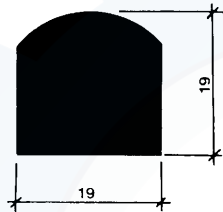

P 693 gr./mt. 425 60 Sh

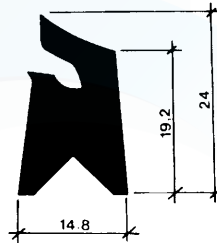

P 694 gr./mt. 285 60 Sh

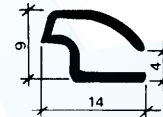

P 695 gr./mt. 20 50 Sh

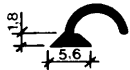

P 696 gr./mt. 28 60 Sh

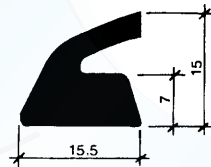

P 697 gr./mt. 190 50 Sh

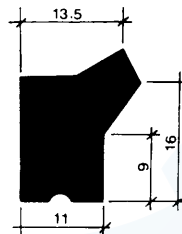

P 698 gr./mt. 290 60 Sh

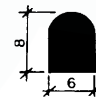

P 699 gr./mt. 57 50 Sh



P 700 gr./mt. 31 70 Sh

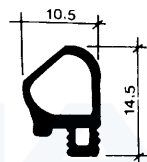

P 701 gr./mt. 75 Sh

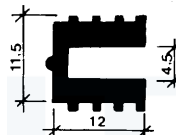

P 702 gr./mt. 118 60 Sh

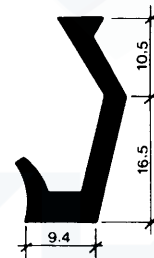

P 703 gr./mt. 148 60 Sh

ARTICOLI TECNICI IN GOMMA E SILICONE

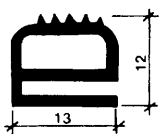

P 704 gr./mt. 110 60 Sh

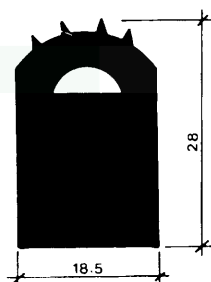

P 705 gr./mt. 580 70 Sh

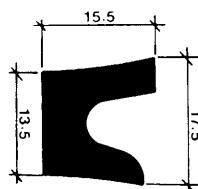

P 706 gr./mt. 210 60 Sh

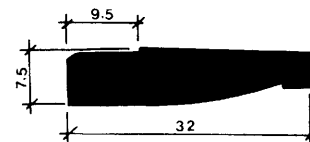

P 707 gr./mt. 250 70 Sh

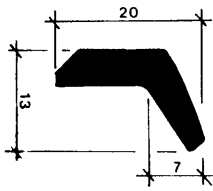

P 708 gr./mt. 130 70 Sh

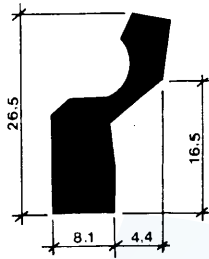

P 709 gr./mt. 220 70 Sh

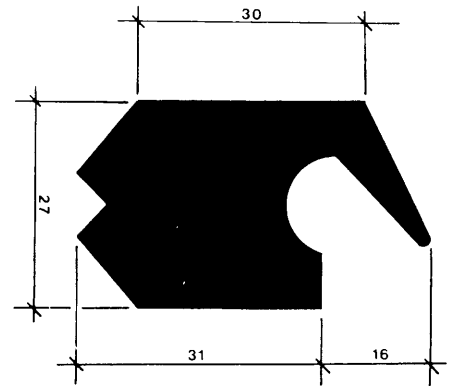

P 710 gr./mt. 950 60 Sh

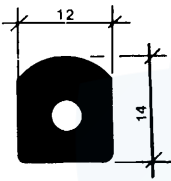

P 711 gr./mt. 180 70 Sh

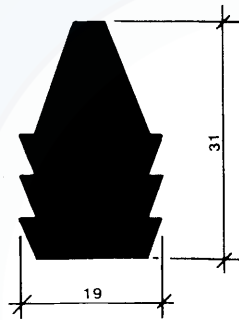

P 712 gr./mt. 520 70 Sh

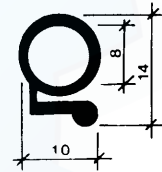

P 713 gr./mt. 33

P 714 gr./mt. 62 60 Sh

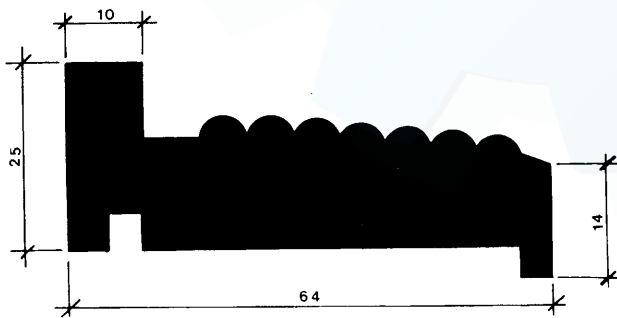

P 715 gr./mt. 1380 50 Sh

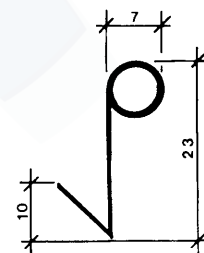

P 716 gr./mt. 65 50 Sh

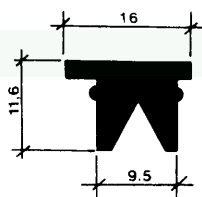

P 717 gr./mt. 138 60 Sh

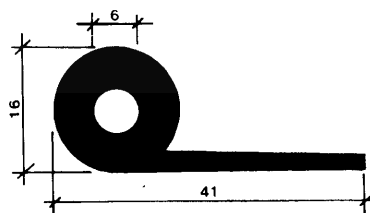

P 718 gr./mt. 315 60 Sh

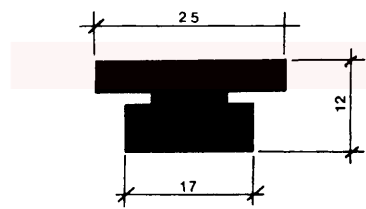

P 719 gr./mt. 275 50 Sh

QUALITYAV
 ARTICOLI TECNICI IN GOMMA E SILICONE

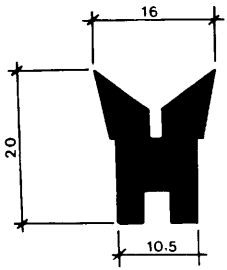

P 720 gr./mt. 270 50 Sh

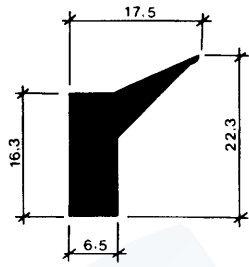

P 721 gr./mt. 200 50 Sh

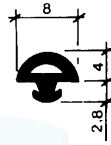

P 722 gr./mt. 36 60 Sh

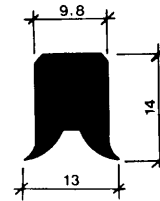

P 723 gr./mt. 180 60 Sh

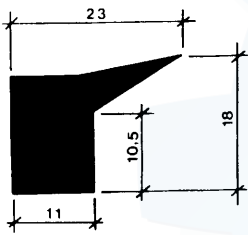

P 724 gr./mt. 270 60 Sh

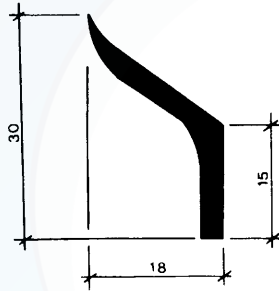

P 725 gr./mt. 127 60 Sh

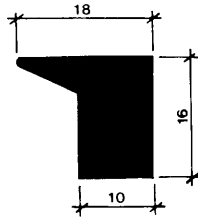

P 726 gr./mt. 231 70 Sh

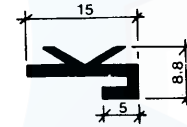

P 727 gr./mt. 84 60 Sh

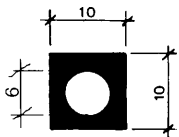

P 728 gr./mt. 95 50 Sh

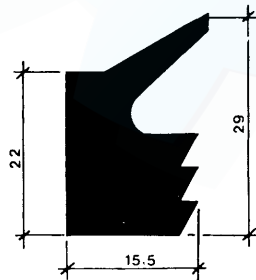

P 729 gr./mt. 390 60 Sh

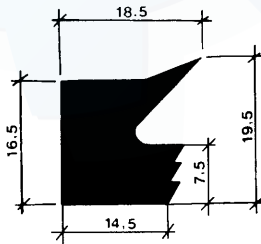

P 730 gr./mt. 290 60 Sh

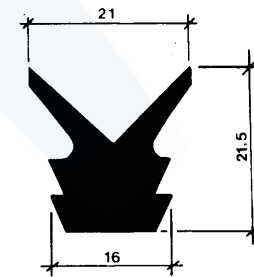

P 731 gr./mt. 357 60 Sh

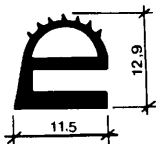

P 732 gr./mt. 85 50 Sh

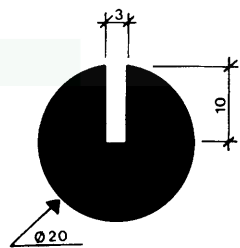

P 733 gr./mt. 340 50 Sh

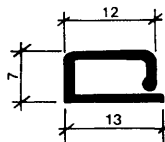

P 734 gr./mt. 60 50 Sh

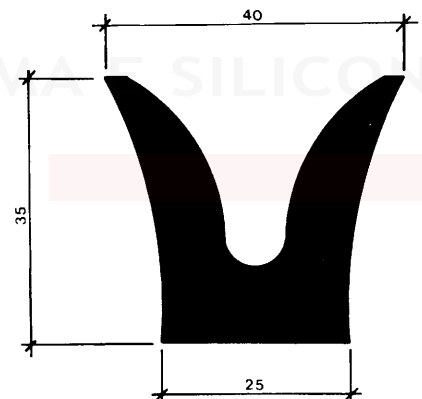

P 735 gr./mt. 910 70 Sh

QUALITY
ARTICOLI TECNICI IN GOMMA E SILICONE

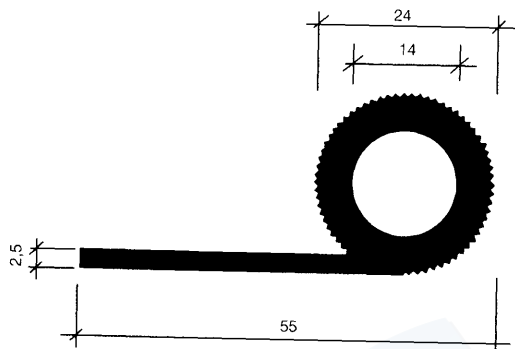

P 736 gr./mt. 448 70 Sh

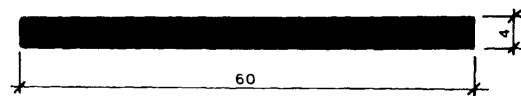

P 737 gr./mt. 320 70 Sh

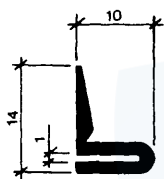

P 738 gr./mt. 40 70 Sh

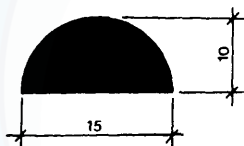

P 739 gr./mt. 155 60 Sh

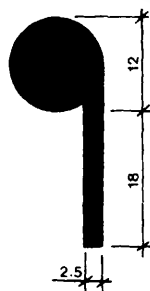

P 740 gr./mt. 220 60 Sh

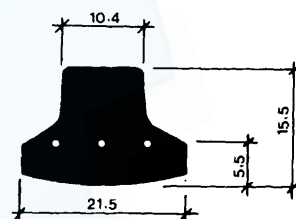

P 741 gr./mt. 270 70 Sh

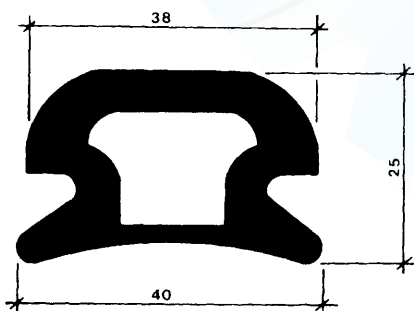

P 742 gr./mt. 720 70 Sh



P 743 gr./mt. 27 60 Sh

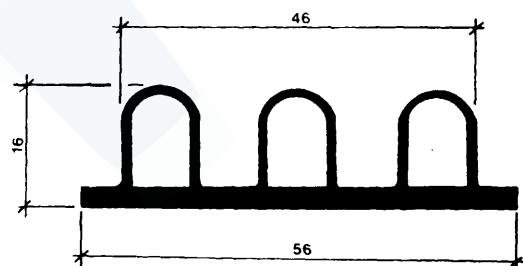

P 744 gr./mt. 340 60 Sh

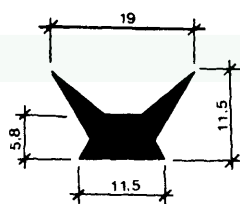

P 745 gr./mt. 100 60 Sh

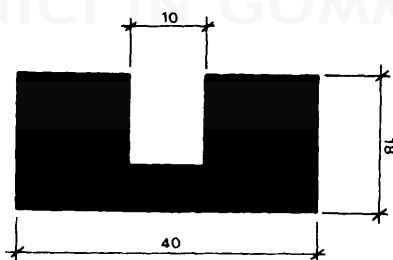

P 746 gr./mt. 810 60 Sh

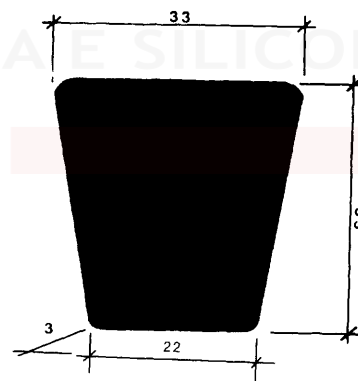

P 747 gr./mt. 1170 60 Sh

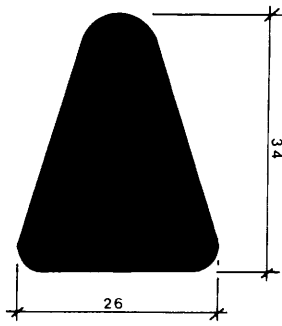

P 748 gr./mt. 760 60 Sh

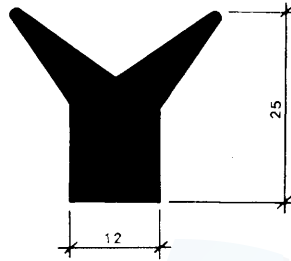

P 749 gr./mt. 435 70 Sh

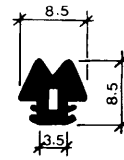

P 750 gr./mt. 55 60 Sh



P 751 gr./mt. 870 50 Sh

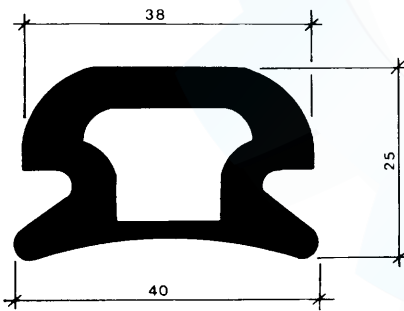

P 752 gr./mt. 720 50 Sh

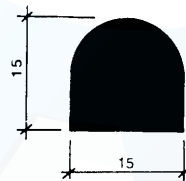

P 753 gr./mt. 260 60 Sh

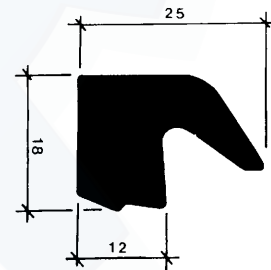

P 754 gr./mt. 370 70 Sh

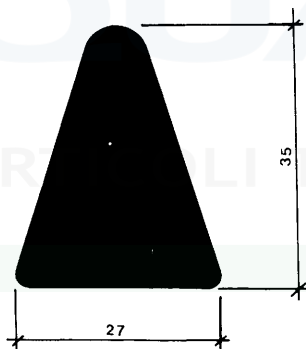

P 755 gr./mt. 775 60 Sh

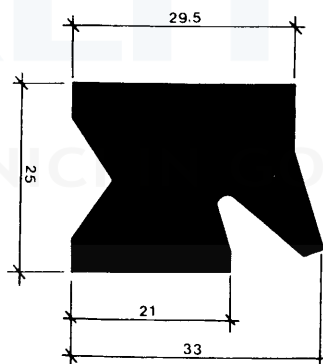

P 756 gr./mt. 830 70 Sh

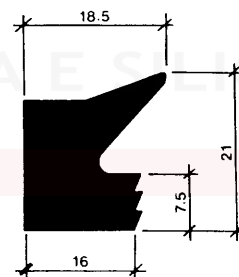

P 757 gr./mt. 286 50 Sh

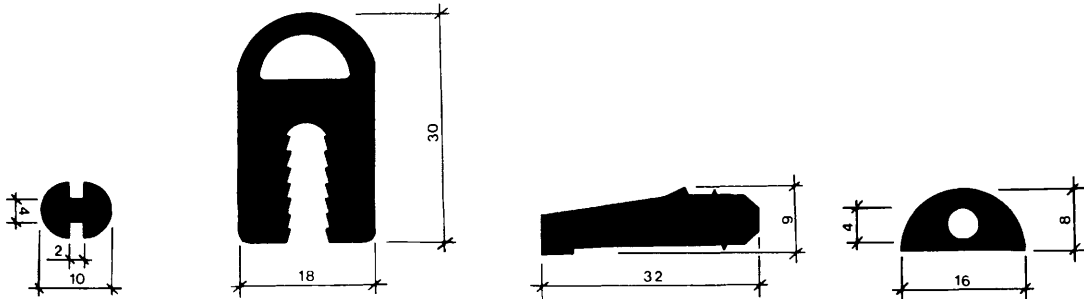

P 758 gr./mt. 95 70 Sh

P 759 gr./mt. 475 60 Sh

P 760 gr./mt. 295 70 Sh

P 761 gr./mt. 120 50 Sh

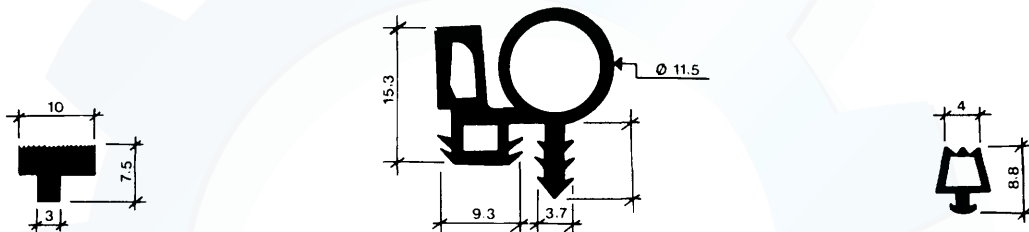

P 762 gr./mt. 65 60 Sh

P 763 gr./mt. 130 60 Sh

P 764 gr./mt. 40 60 Sh

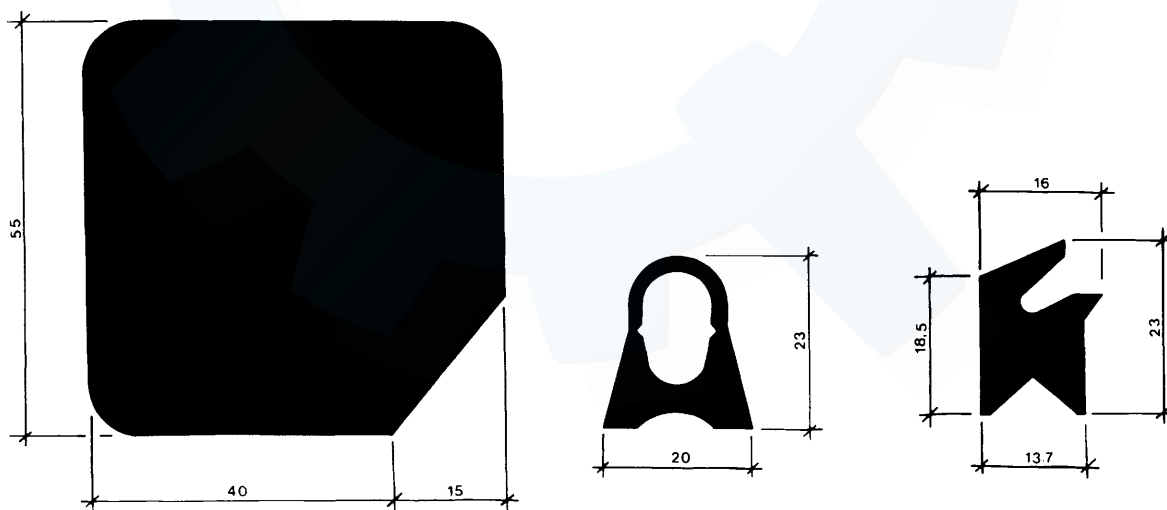

P 765 gr./mt. 3340 60 Sh

P 766 gr./mt. 110 60 Sh

P 767 gr./mt. 290 60 Sh

ARTICOLI TECNICI IN GOMMA E SILICONE

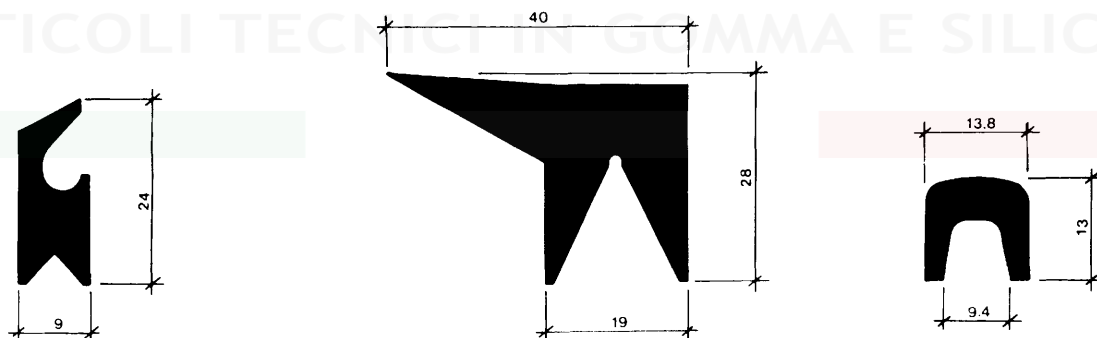

P 768 gr./mt. 220 60 Sh

P 769 gr./mt. 510 60 Sh

P 770 gr./mt. 140 60 Sh

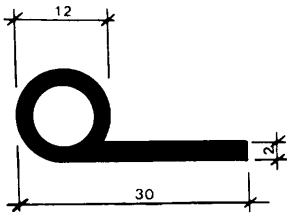

P 771 gr./mt. 135 60 Sh

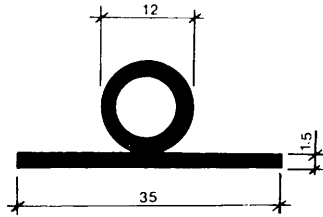

P 772 gr./mt. 140 60 Sh

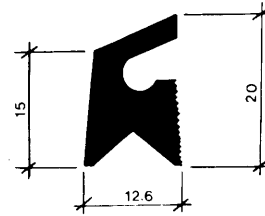

P 773 gr./mt. 170 70 Sh

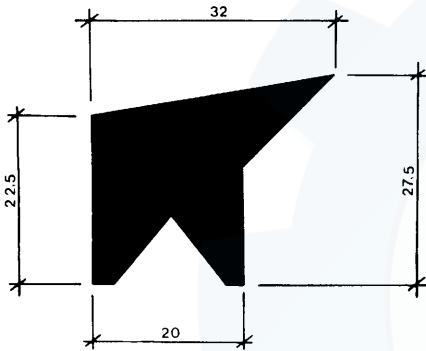

P 774 gr./mt. 630 60 Sh

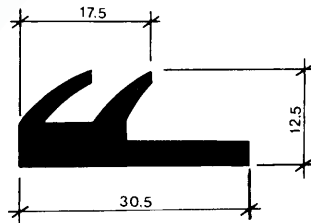

P 775 gr./mt. 200 50 Sh

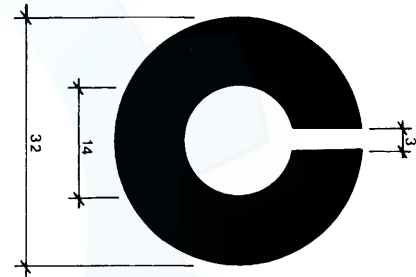

P 776 gr./mt. 763 60 Sh

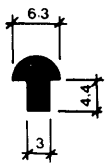

P 777 gr./mt. 37 70 Sh

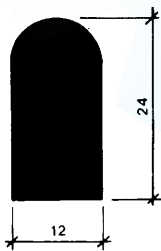

P 778 gr./mt. 310 60 Sh

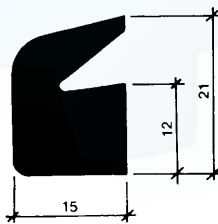

P 779 gr./mt. 310 70 Sh

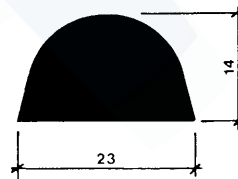

P 780 gr./mt. 310 50 Sh

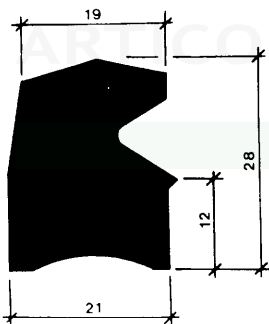

P 781 gr./mt. 573 60 Sh

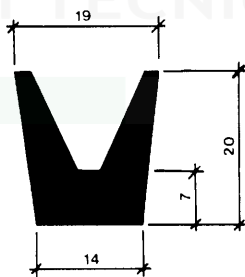

P 782 gr./mt. 295 60 Sh

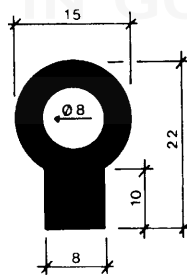

P 783 gr./mt. 255 60 Sh

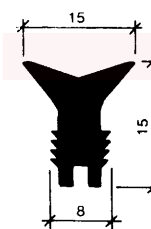

P 784 gr./mt. 152 60 Sh

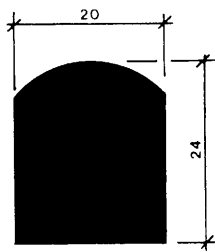

P 785 gr./mt. 550 60 Sh

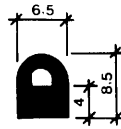

P 786 gr./mt. 53 50 Sh

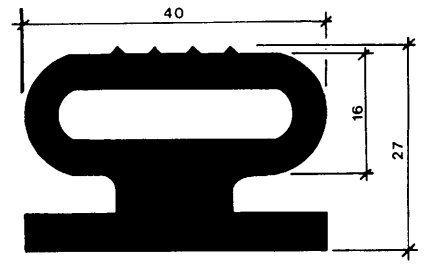

P 787 gr./mt. 775 50 Sh

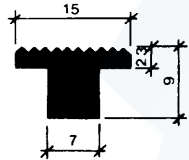

P 788 gr./mt. 85 60 Sh

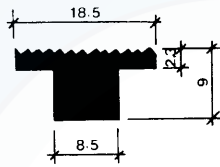

P 789 gr./mt. 120 60 Sh

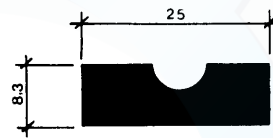

P 790 gr./mt. 235 60 Sh

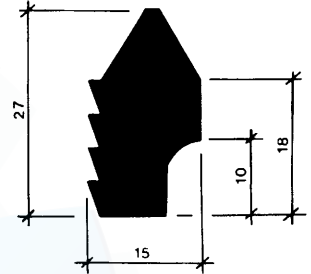

P 791 gr./mt. 340 70 Sh

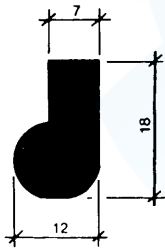

P 792 gr./mt. 195 70 Sh

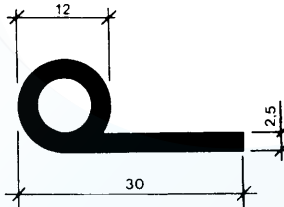

P 793 gr./mt. 160 50 Sh

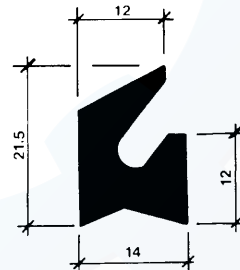

P 794 gr./mt. 238 50 Sh

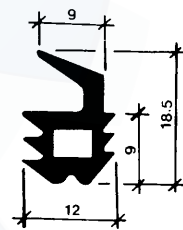

P 795 gr./mt. 145 60 Sh

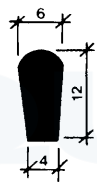

P 796 gr./mt. 70 50 Sh

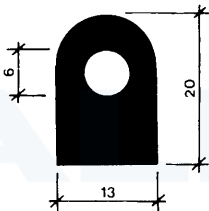

P 797 gr./mt. 245 50 Sh

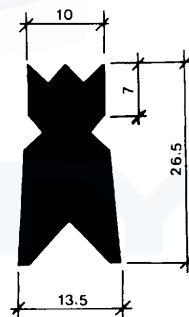

P 798 gr./mt. 311 60 Sh

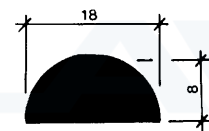

P 799 gr./mt. 134 60 Sh

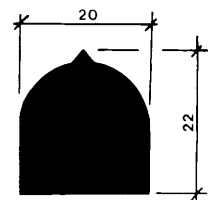

P 800 gr./mt. 455 60 Sh

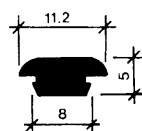

P 801 gr./mt. 65 60 Sh

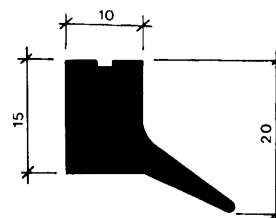

P 802 gr./mt. 230 70 Sh

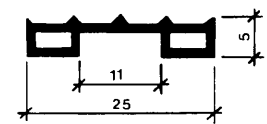

P 803 gr./mt. 90 70 Sh

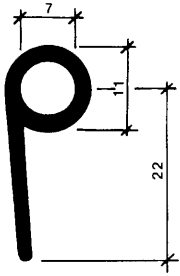

P 804 gr./mt. 130 60 Sh

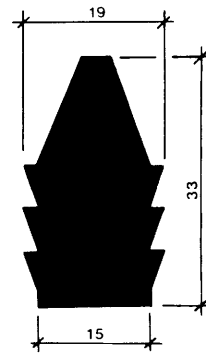

P 805 gr./mt. 538 70 Sh

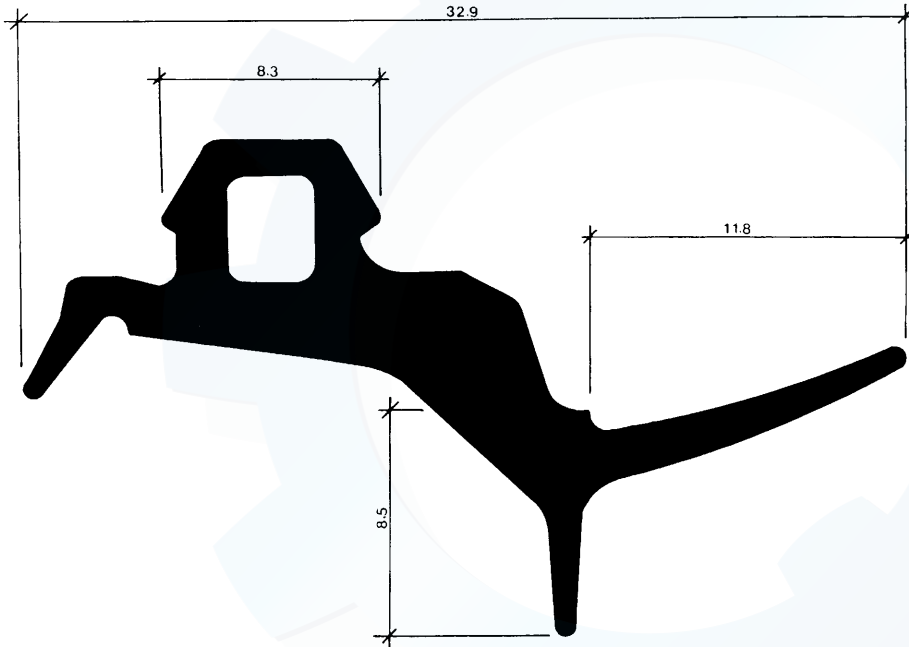

P 806 gr./mt. 177 60 Sh

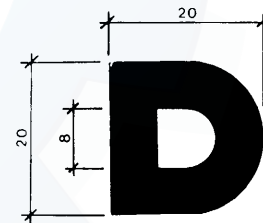

P 807 gr./mt. 340 60 Sh



P 808 gr./mt. 47 60 Sh

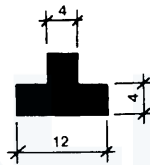

P 809 gr./mt. 78 60 Sh

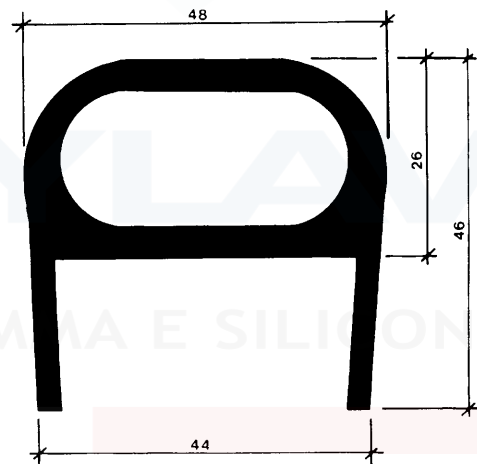

P 810 gr./mt. 850 70 Sh

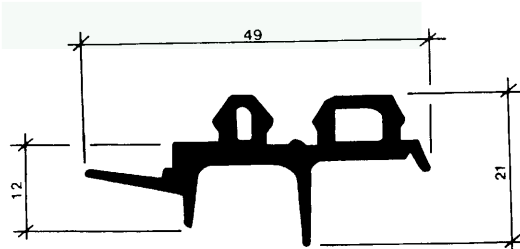

P 811 gr./mt. 320 60 Sh

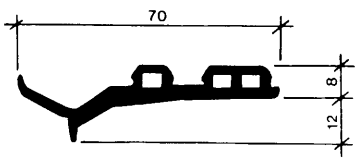

P 812 gr./mt. 380 60 Sh

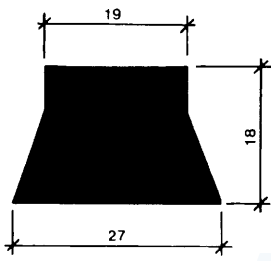

P 813 gr./mt. 452 40 Sh

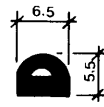

P 814 gr./mt. 39 50 Sh

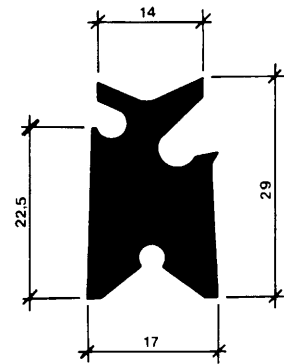

P 815 gr./mt. 405 70 Sh

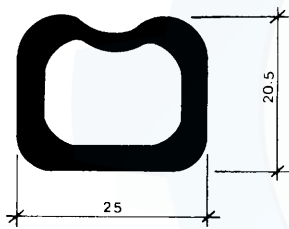

P 816 gr./mt. 290 60 Sh

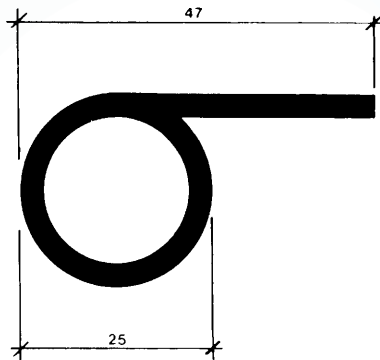

P 817 gr./mt. 308 60/70 Sh



P 818 gr./mt. 150 70 Sh

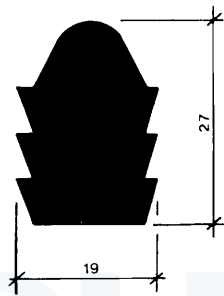

P 819 gr./mt. 500 60 Sh

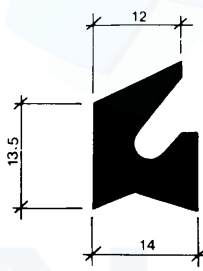

P 820 gr./mt. 230 60 Sh

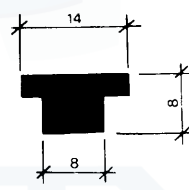

P 821 gr./mt. 105 60 Sh

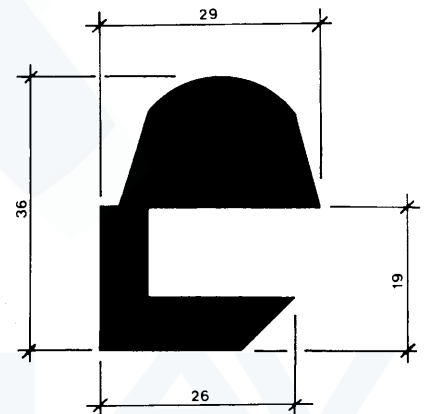

P 822 gr./mt. 720 60 Sh

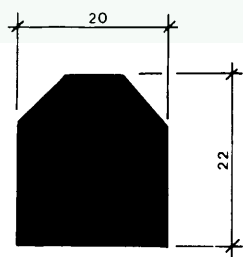

P 823 gr./mt. 540 70 Sh

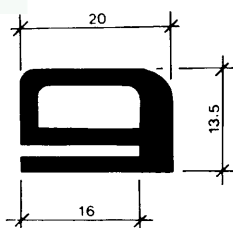

P 824 gr./mt. 196 60 Sh

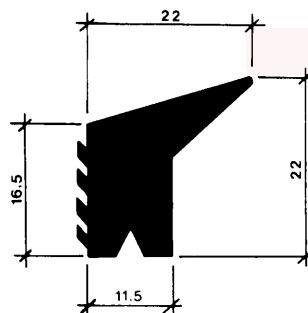

P 825 gr./mt. 335 70 Sh

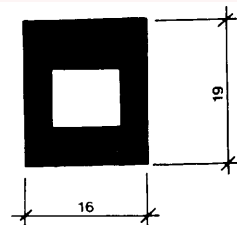

P 826 gr./mt. 320 60 Sh

ARTICOLI TECNICI IN GOMMA E SILICONE

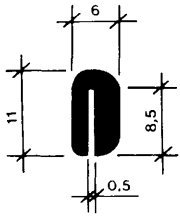

P 827 gr./mt. 67 60 Sh

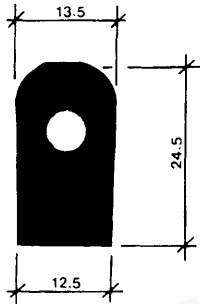

P 828 gr./mt. 325 50 Sh

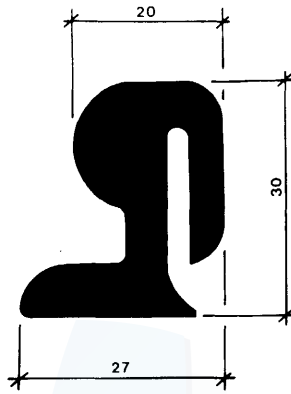

P 829 gr./mt. 550 50 Sh

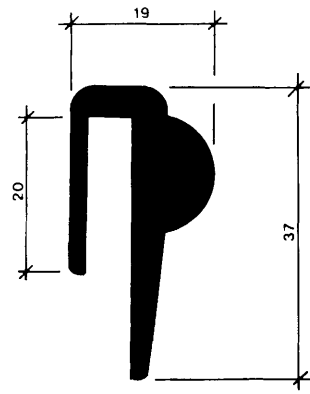

P 830 gr./mt. 360 70 Sh

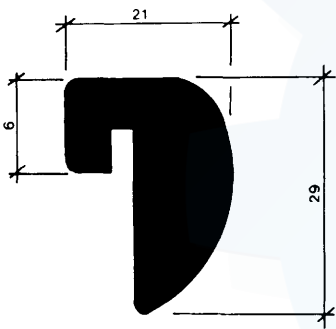

P 831 gr./mt. 450 50 Sh

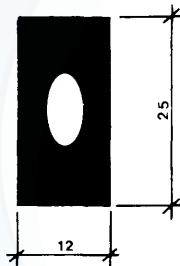

P 832 gr./mt. 335 60 Sh

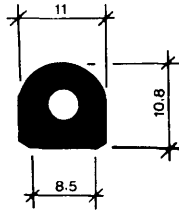

P 833 gr./mt. 110 60 Sh

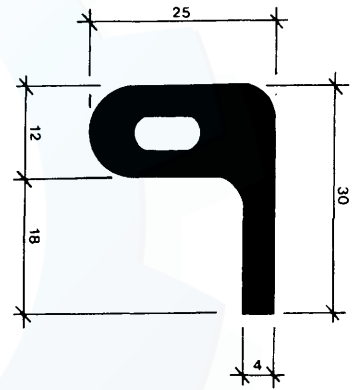

P 834 gr./mt. 420 60 Sh

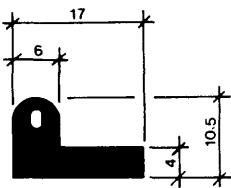

P 835 gr./mt. 140 60 Sh

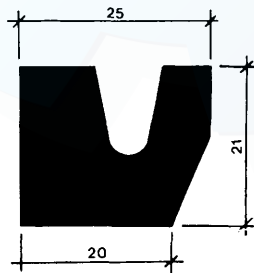

P 836 gr./mt. 580 70 Sh

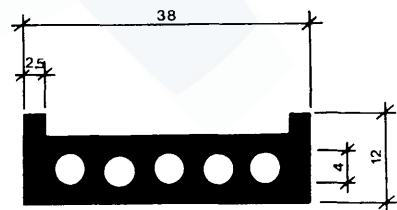

P 837 gr./mt. 380 60 Sh

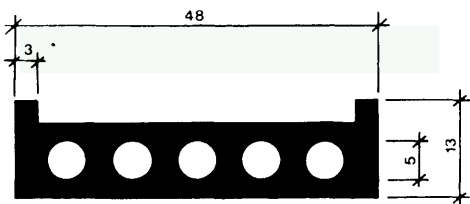

P 838 gr./mt. 560 60 Sh

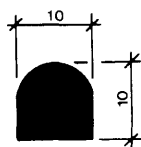

P 839 gr./mt. 109 60 Sh

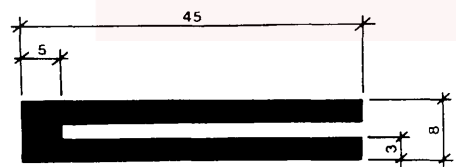

P 840 gr./mt. 390 60 Sh

QUALITYAV
ARTICOLI TECNICI IN GOMMA E SILICONE

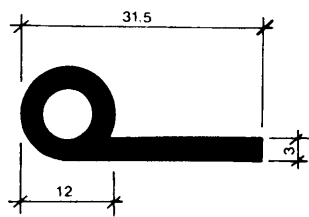

P 841 gr./mt. 190 50 Sh

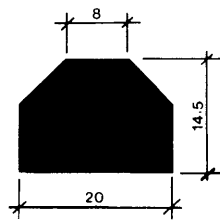

P 842 gr./mt. 295 60 Sh

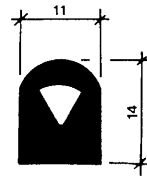

P 843 gr./mt. 165 60 Sh

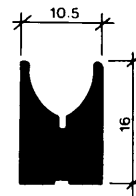

P 844 gr./mt. 155 70 Sh

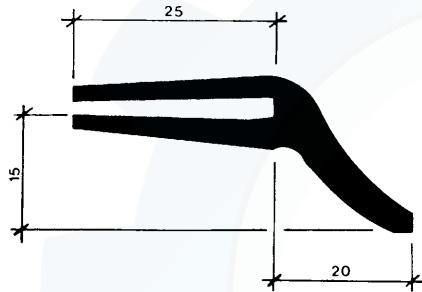

P 845 gr./mt. 414 60 Sh

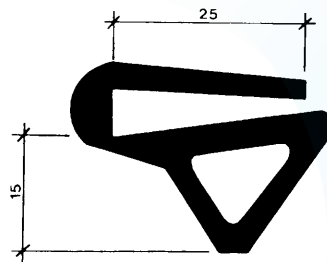

P 846 gr./mt. 465 60 Sh



P 847 gr./mt. 16 60 Sh

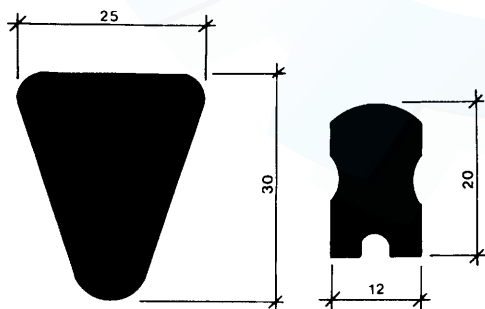

P 848 gr./mt. 750 80 Sh

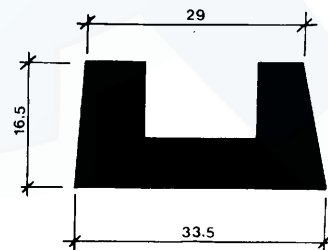

P 849 gr./mt. 260 80 Sh

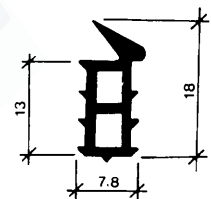

P 850 gr./mt. 435 50 Sh

P 851 gr./mt. 92 60 Sh

QUALITYLAW
ARTICOLI TECNICI IN GOMMA E SILICONE

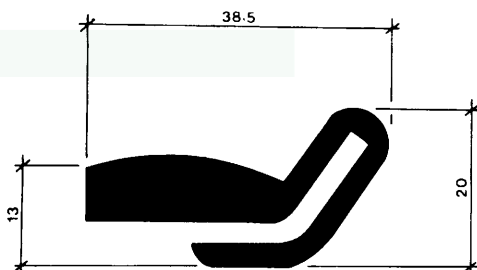

P 852 gr./mt. 480 60 Sh



P 853 gr./mt. 710 60 Sh

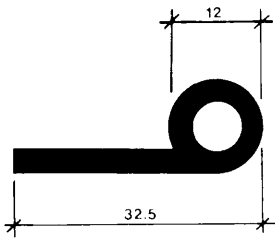

P 854 gr./mt. 200 60 Sh

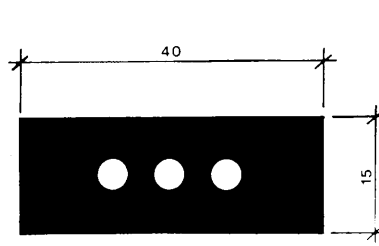

P 855 gr./mt. 660 40 Sh

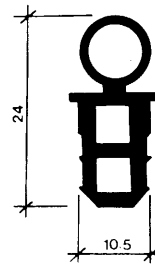

P 856 gr./mt. 146 50 Sh

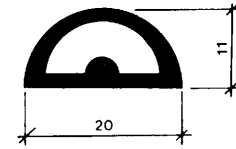

P 857 gr./mt. 135 60 Sh

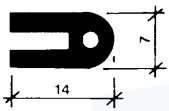

P 858 gr./mt. 94 60 Sh

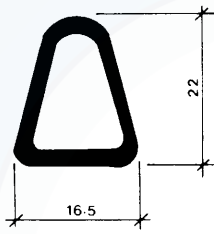

P 859 gr./mt. 150 60 Sh

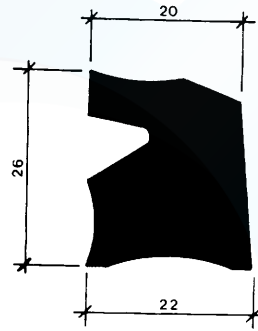

P 860 gr./mt. 603 70 Sh

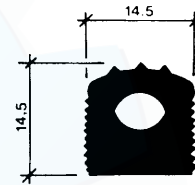

P 861 gr./mt. 220 60 Sh

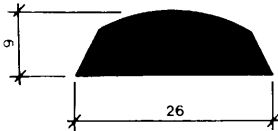

P 862 gr./mt. 240 50 Sh

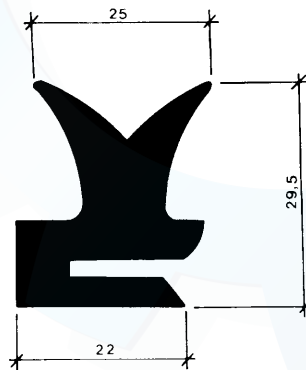

P 863 gr./mt. 430 60 Sh

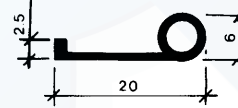

P 864 gr./mt. 44 70 Sh

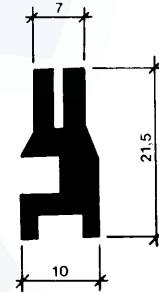

P 865 gr./mt. 170 70 Sh

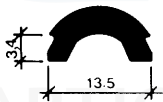

P 866 gr./mt. 82 70 Sh

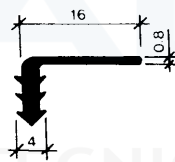

P 867 gr./mt. 40 60 Sh

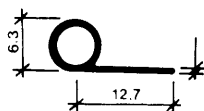

P 868 gr./mt. 27 50 Sh

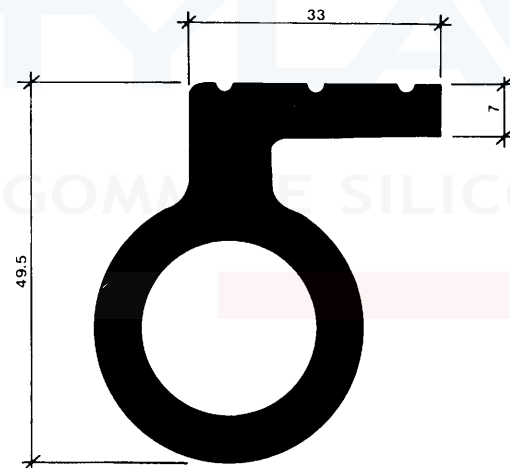

P 869 gr./mt. 1030 50 Sh

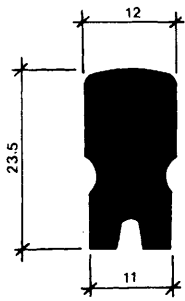

P 870 gr./mt. 300 70 Sh

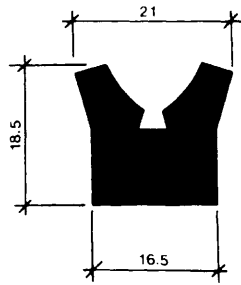

P 871 gr./mt. 352 60 Sh

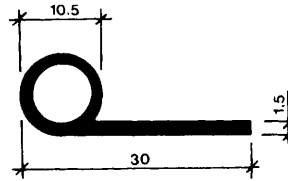

P 872 gr./mt. 95 50 Sh

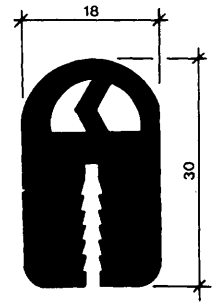

P 873 gr./mt. 525 60 Sh

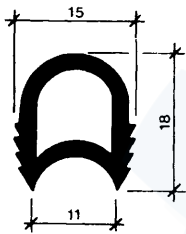

P 874 gr./mt. 133 60 Sh

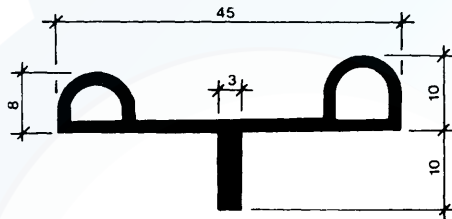

P 875 gr./mt. 225 60 Sh

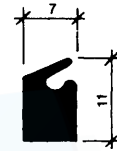

P 876 gr./mt. 85 60 Sh

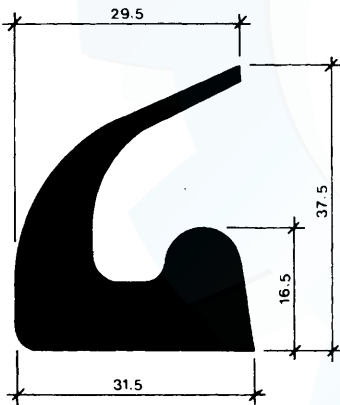

P 877 gr./mt. 730 50 Sh

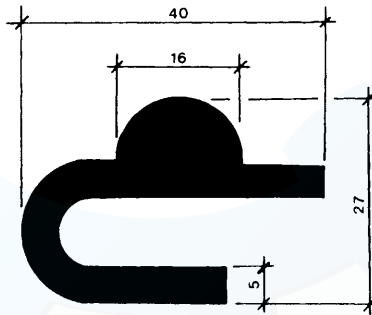

P 878 gr./mt. 574 50 Sh

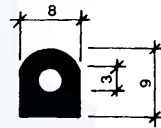

P 879 gr./mt. 70 60 Sh

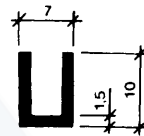

P 880 gr./mt. 42 60 Sh

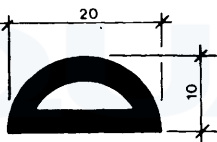

P 881 gr./mt. 170 60 Sh

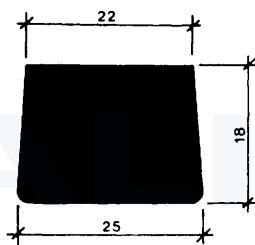

P 882 gr./mt. 540 60 Sh

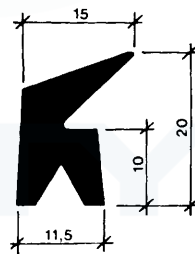

P 883 gr./mt. 225 60 Sh



P 884 gr./mt. 265 70 Sh

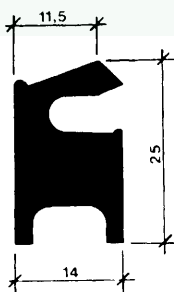

P 885 gr./mt. 295 70 Sh

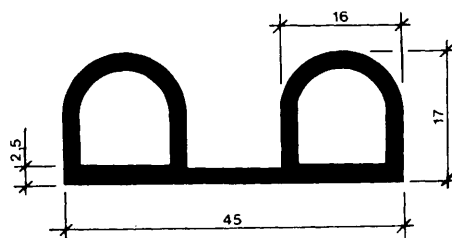

P 886 gr./mt. 302 60 Sh

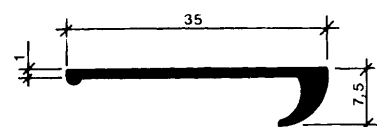

P 887 gr./mt. 74 60 Sh

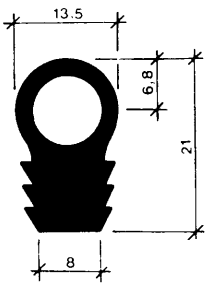

P 888 gr./mt. 238 60 Sh

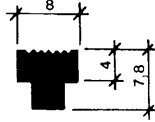

P 889 gr./mt. 325 60 Sh

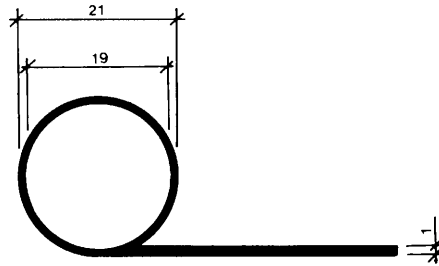

P 890 gr./mt. 145 70 Sh

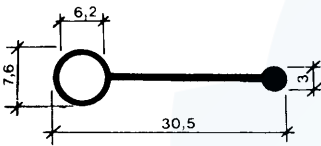

P 891 gr./mt. 60 60 Sh

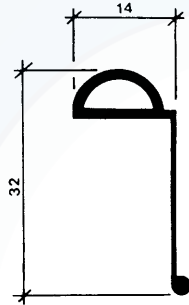

P 892 gr./mt. 73 60 Sh

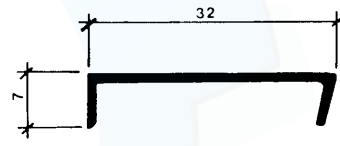

P 893 gr./mt. 64 60 Sh

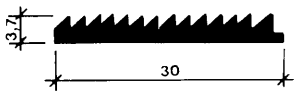

P 894 gr./mt. 70 50 Sh

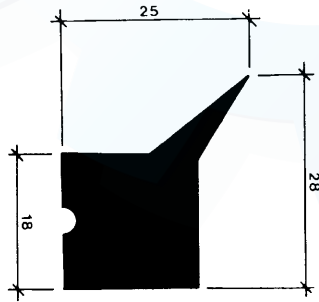

P 895 gr./mt. 426 60 Sh



P 896 gr./mt. 18 60 Sh

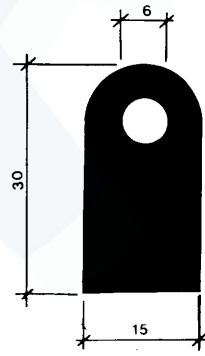

P 897 gr./mt. 486 50 Sh

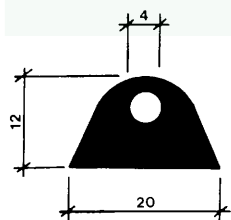

P 898 gr./mt. 185 60 Sh

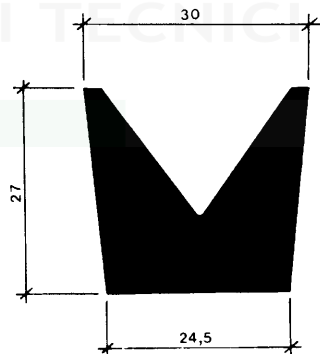

P 899 gr./mt. 700 60 Sh

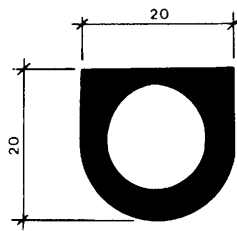

P 900 gr./mt. 291 60 Sh

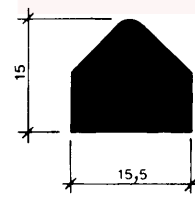

P 901 gr./mt. 230 40 Sh

QUALITYLAW

ARTICOLI TECNICI IN GOMMA E SILICONE

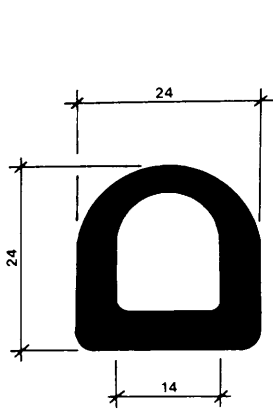

P 902 gr./mt. 333 60 Sh

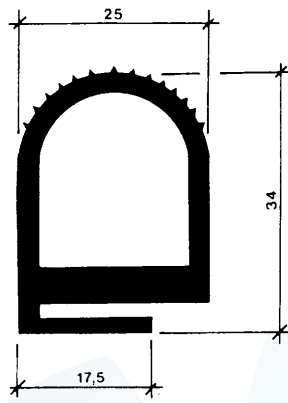

P 903 gr./mt. 360 70 Sh

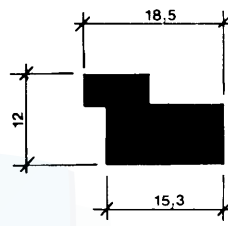

P 904 gr./mt. 206 60 Sh

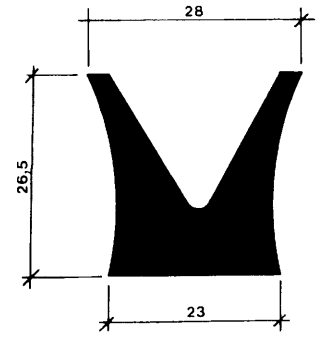

P 905 gr./mt. 495 60 Sh

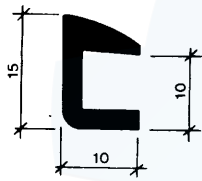

P 906 gr./mt. 92 60 Sh

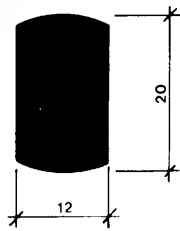

P 907 gr./mt. 265 50 Sh

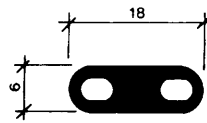

P 908 gr./mt. 90 50 Sh



P 909 gr./mt. 6 70 Sh

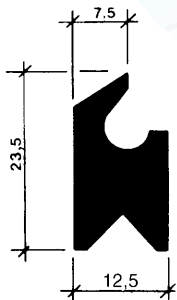

P 910 gr./mt. 240 60 Sh

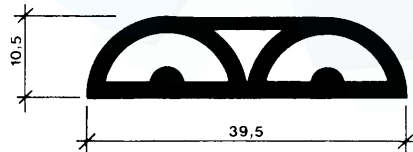

P 911 gr./mt. 290 60 Sh

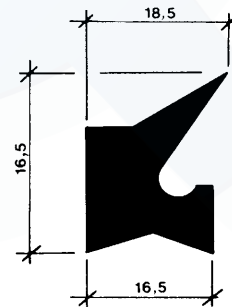

P 912 gr./mt. 300 60 Sh

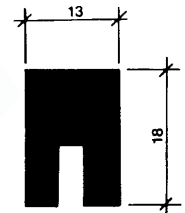

P 913 gr./mt. 270 70 Sh

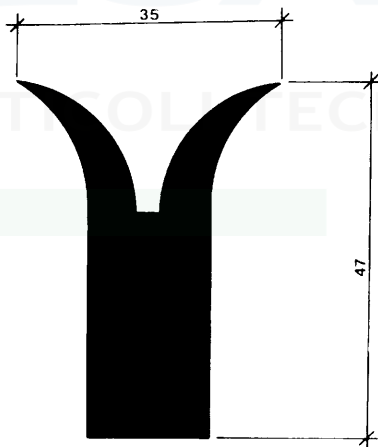

P 914 gr./mt. 810 60 Sh

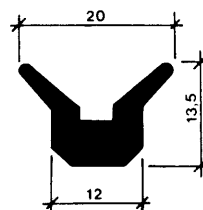

P 915 gr./mt. 140 40 Sh

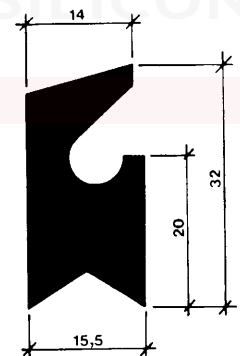

P 916 gr./mt. 460 60 Sh

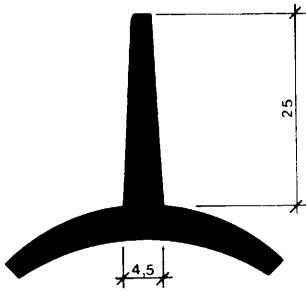

P 917 gr./mt. 259 60 Sh

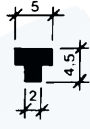

P 918 gr./mt. 19 60 Sh

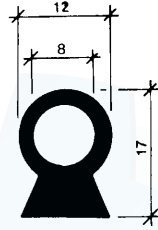

P 919 gr./mt. 140 60 Sh

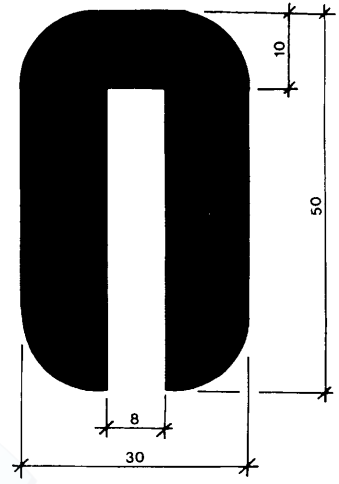

P 920 gr./mt. 1250 60 Sh

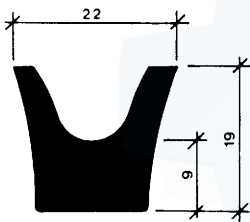

P 921 gr./mt. 295 50 Sh

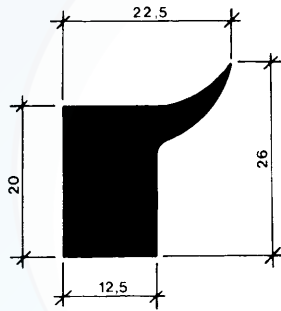

P 922 gr./mt. 350 60 Sh

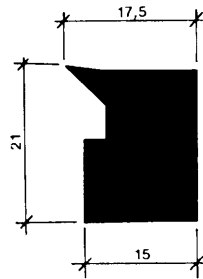

P 923 gr./mt. 350 60 Sh

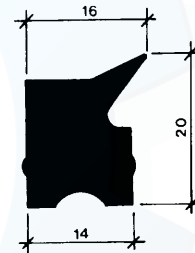

P 924 gr./mt. 270 70 Sh

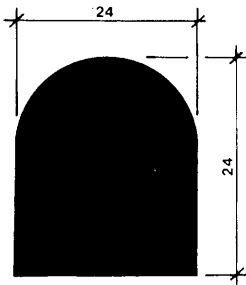

P 925 gr./mt. 660 60 Sh

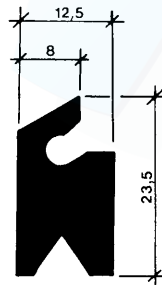

P 926 gr./mt. 242 60 Sh

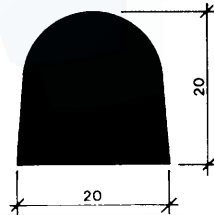

P 927 gr./mt. 400 40 Sh

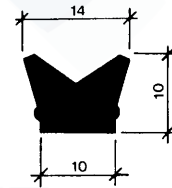

P 928 gr./mt. 111 60 Sh

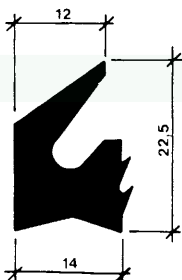

P 929 gr./mt. 240 50 Sh

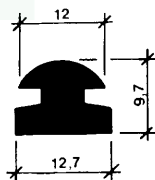

P 930 gr./mt. 124 70 Sh

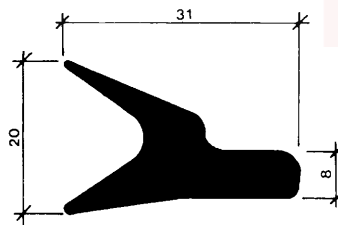

P 931 gr./mt. 365 70 Sh

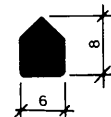

P 932 gr./mt. 45 60 Sh

QUALITYLAV

ARTICOLI TECNICI IN GOMMA E SILICONE

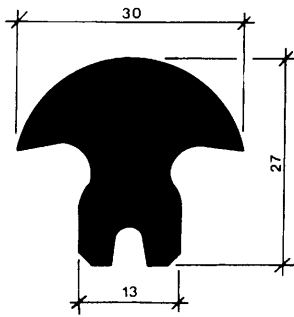

P 933 gr./mt. 512 70 Sh

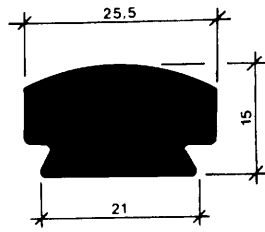

P 934 gr./mt. 339 40 Sh

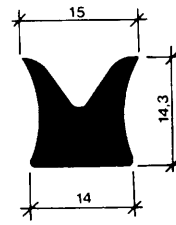

P 935 gr./mt. 189 60 Sh

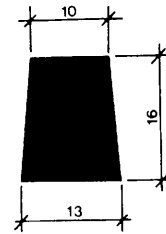

P 936 gr./mt. 236 60 Sh

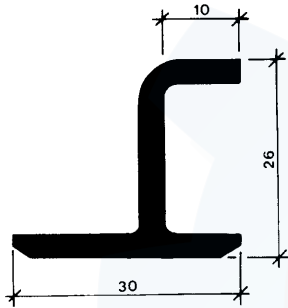

P 937 gr./mt. 265 70 Sh

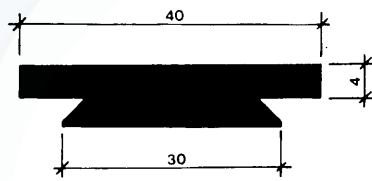

P 938 gr./mt. 300 40 Sh

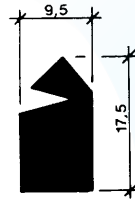

P 939 gr./mt. 170 70 Sh

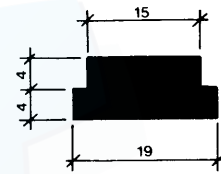

P 940 gr./mt. 174 70 Sh

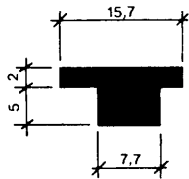

P 941 gr./mt. 87 60 Sh



P 942 gr./mt. 290 50 Sh

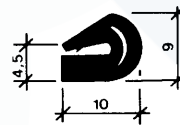

P 943 gr./mt. 78 60 Sh

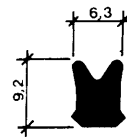

P 944 gr./mt. 68 60 Sh

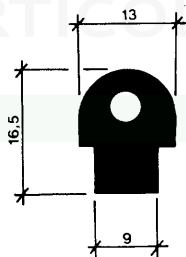

P 945 gr./mt. 183 50 Sh

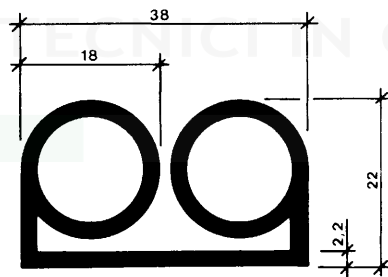

P 946 gr./mt. 370 60 Sh

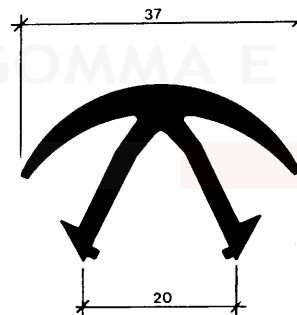

P 947 gr./mt. 285 70 Sh



P 948 gr./mt. 86 60 Sh

QUALITYLAV

ARTICOLI FUNZION IN GOMMA E SILICONE

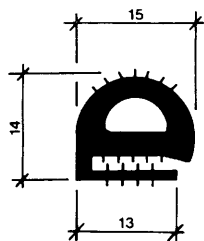

P 949 gr./mt. 123 50 Sh

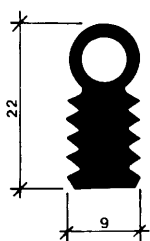

P 950 gr./mt. 199 60 Sh

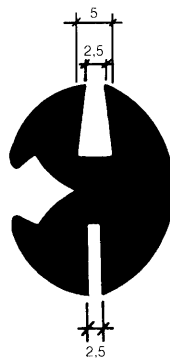

P 951 gr./mt. 468 60 Sh

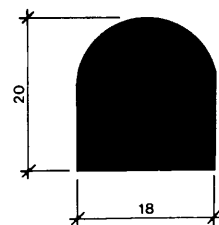

P 952 gr./mt. 380 50 Sh

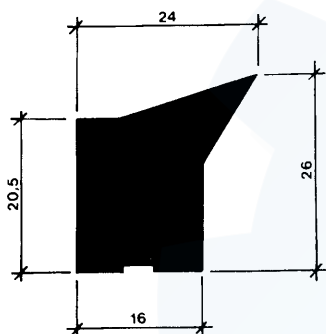

P 953 gr./mt. 462 60 Sh

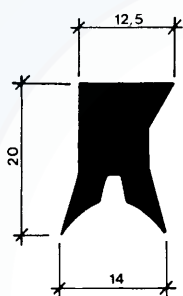

P 954 gr./mt. 200 70 Sh

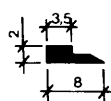

P 955 gr./mt. 18 60 Sh

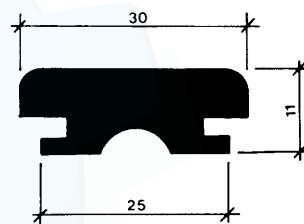

P 956 gr./mt. 318 70 Sh

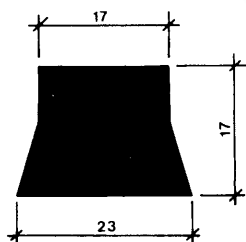

P 957 gr./mt. 360 30 Sh

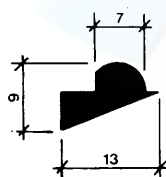

P 958 gr./mt. 86 60 Sh

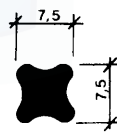

P 959 gr./mt. 53 60 Sh



P 960 gr./mt. 510 60 Sh

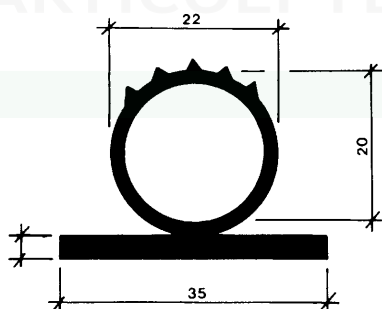

P 961 gr./mt. 260 60 Sh

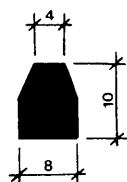

P 962 gr./mt. 91 60 Sh

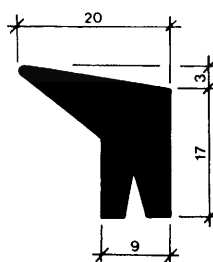

P 963 gr./mt. 265 60 Sh

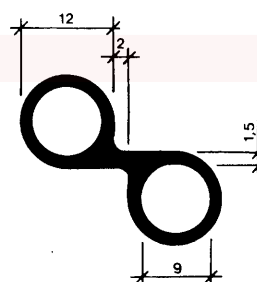

P 964 gr./mt. 188 60 Sh

QUALITYLAV
ARTICOLI TECNICI IN GOMMA E SILICONE

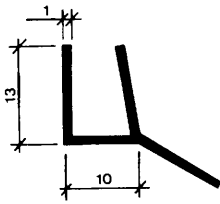

P 965 gr./mt. 47 50 Sh

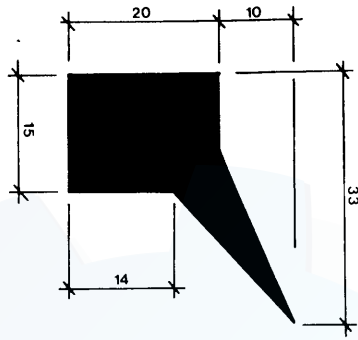

P 966 gr./mt. 497 50 Sh

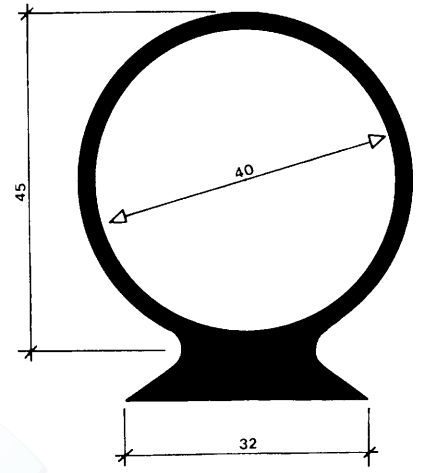

P 967 gr./mt. 640 60 Sh

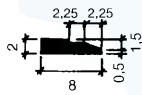

P 968 gr./mt. 13 60 Sh

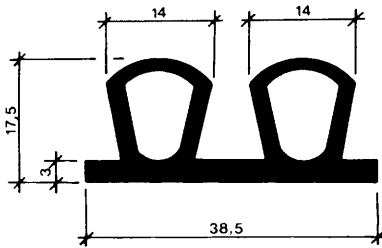

P 969 gr./mt. 357 60 Sh

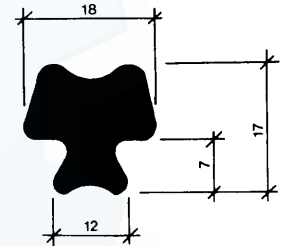

P 970 gr./mt. 263 60 Sh

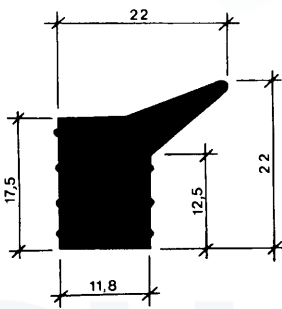

P 971 gr./mt. 312 60 Sh

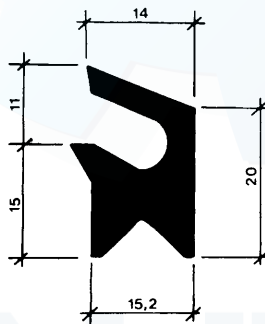

P 972 gr./mt. 288 50 Sh

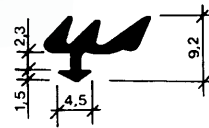

P 973 gr./mt. 62 60 Sh

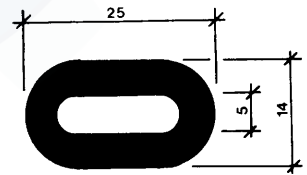

P 974 gr./mt. 300 60 Sh

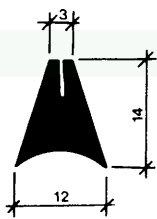

P 975 gr./mt. 86 50 Sh

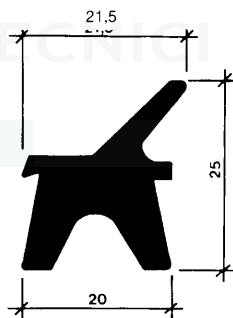

P 976 gr./mt. 290 60 Sh

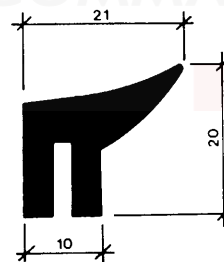

P 977 gr./mt. 211 70 Sh

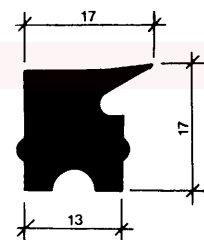

P 978 gr./mt. 252 60 Sh

QUALITY
ARTICOLI TECNICI IN GOMMA E SILICONE

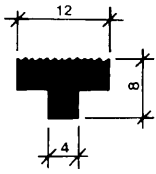

P 979 gr./mt. 80 70 Sh

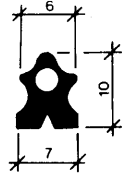

P 980 gr./mt. 53 60 Sh

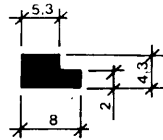

P 981 gr./mt. 33 50 Sh

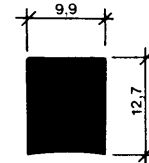

P 982 gr./mt.148 70 Sh

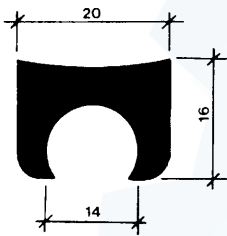

P 983 gr./mt. 210 70 Sh

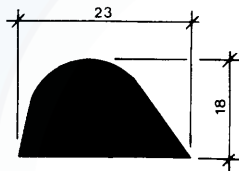

P 984 gr./mt. 385 50 Sh

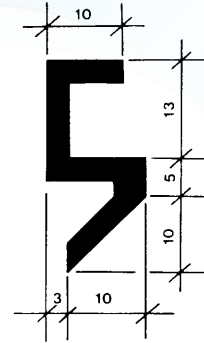

P 985 gr./mt. 174 60 Sh

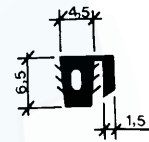

P 986 gr./mt. 37 60 Sh

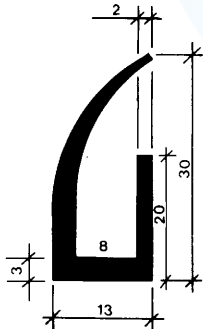

P 987 gr./mt. 198 60 Sh

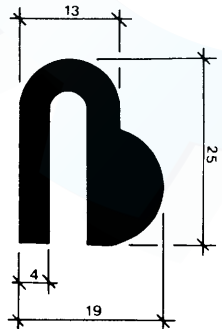

P 988 gr./mt. 300 50 Sh

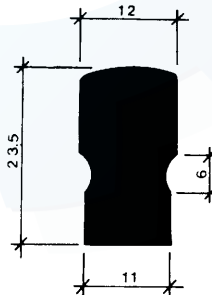

P 989 gr./mt. 321 70 Sh

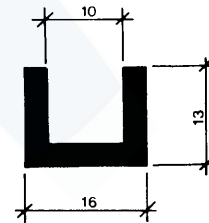

P 990 gr./mt. 137 60 Sh

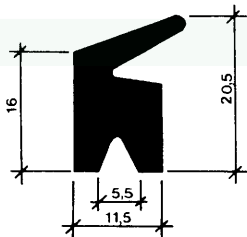

P 991 gr./mt. 203 60 Sh

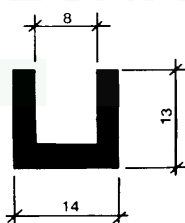

P 992 gr./mt. 137 60 Sh

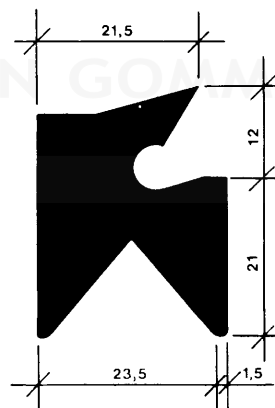

P 993 gr./mt. 590 70 Sh

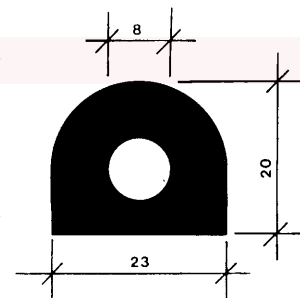

P 994 gr./mt. 432 60 Sh

QUALITYLAV
ARTICOLI TECNICI IN GOMMA E SILICONE

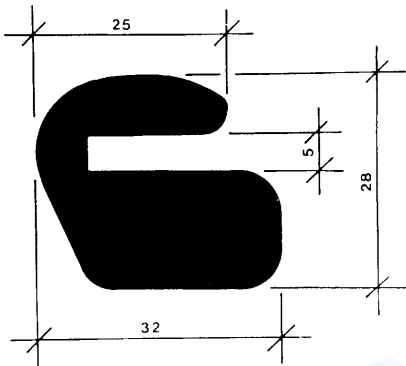

P 995 gr./mt. 720 50 Sh

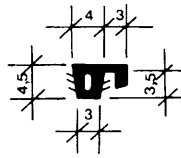

P 996 gr./mt. 29 60 Sh

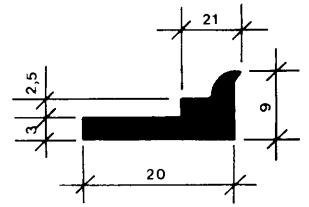

P 997 gr./mt. 121 70 Sh

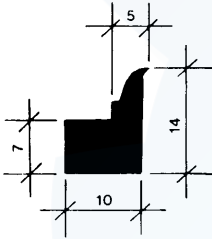

P 998 gr./mt. 126 70 Sh

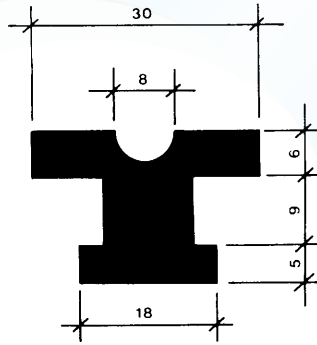

P 999 gr./mt. 444 60 Sh

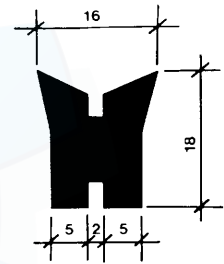

P 1000 gr./mt. 243 60 Sh

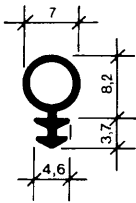

P 1001 gr./mt. 48 60 Sh

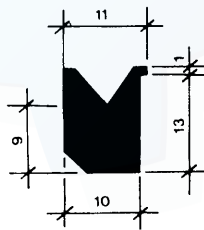

P 1002 gr./mt. 158 60 Sh

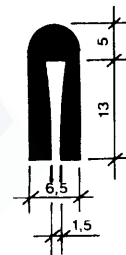

P 1003 gr./mt. 111 60 Sh

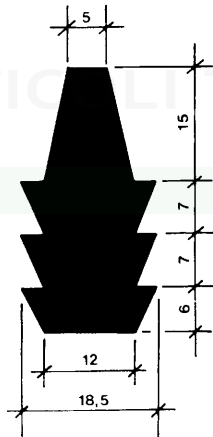

P 1004 gr./mt. 563 70 Sh

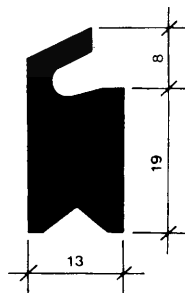

P 1005 gr./mt. 348 60 Sh

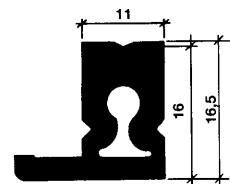

P 1006 gr./mt. 190 60 Sh

QUALITYLAV
ARTICOLI TECNICI IN GOMMA E SILICONE

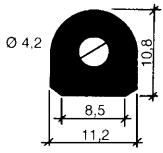

P 1007 gr./mt. 110 70 Sh

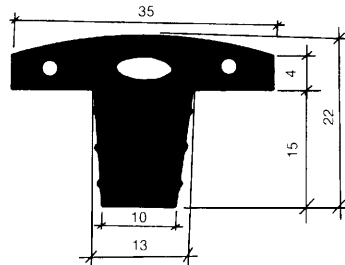

P 1008 gr./mt. 432 50 Sh

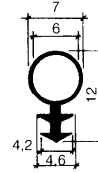

P 1009 gr./mt. 30 60 Sh

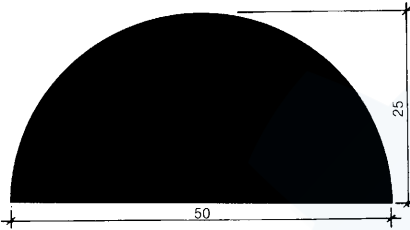

P 1010 gr./mt. 1200 60 Sh

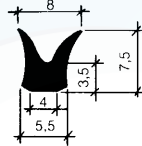

P 1011 gr./mt. 35 60 Sh

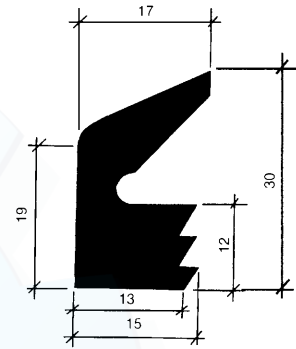

P 1012 gr./mt. 421 60 Sh

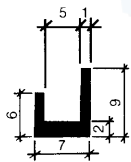

P 1013 gr./mt. 30 70 Sh

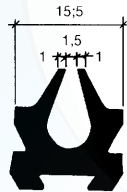

P 1014 gr./mt. 150 70 Sh



P 1015 gr./mt. 4 40 Sh

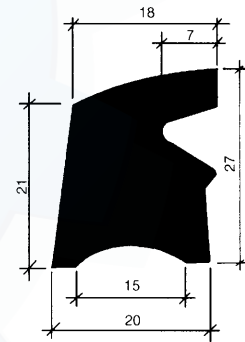

P 1016 gr./mt. 531 60 Sh

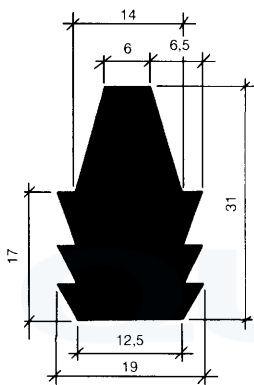

P 1017 gr./mt. 503 70 Sh

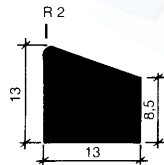

P 1018 gr./mt. 189 70 Sh

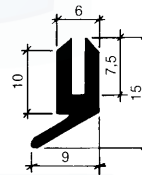

P 1019 gr./mt. 57 60 Sh

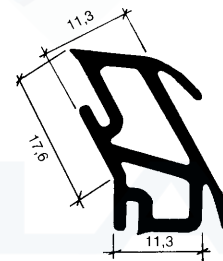

P 1020 gr./mt. 157 70 Sh

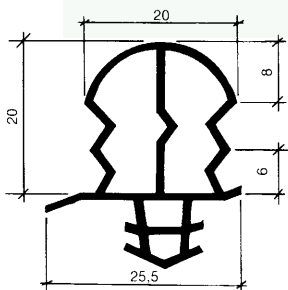

P 1021 gr./mt. 195 60 Sh

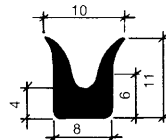

P 1022 gr./mt. 64 60 Sh

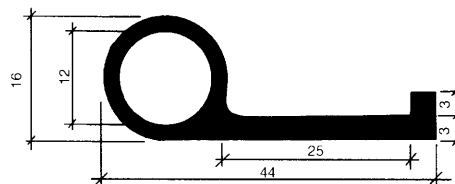

P 1023 gr./mt. 230 60 Sh

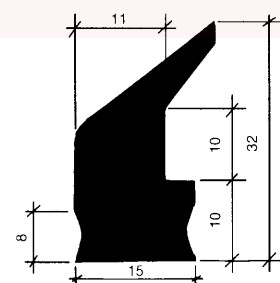

P 1024 gr./mt. 426 60 Sh

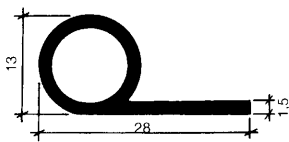

P 1025 gr./mt. 104 50 Sh

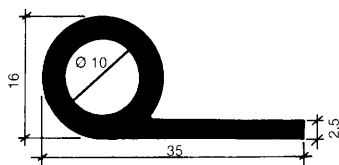

P 1026 gr./mt. 230 60 Sh

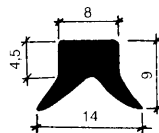

P 1027 gr./mt. 83 60 Sh

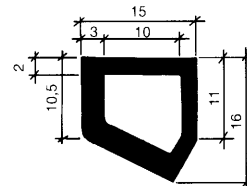

P 1028 gr./mt. 123 60 Sh

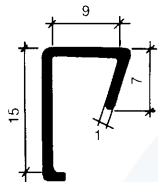

P 1029 gr./mt. 49 60 Sh



P 1030 gr./mt. 75 75 Sh

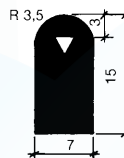

P 1031 gr./mt. 126 70 Sh

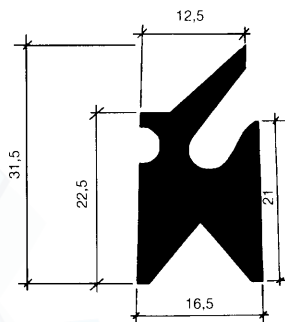

P 1032 gr./mt. 355 60 Sh

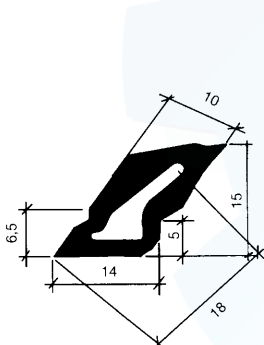

P 1033 gr./mt. 145 60 Sh

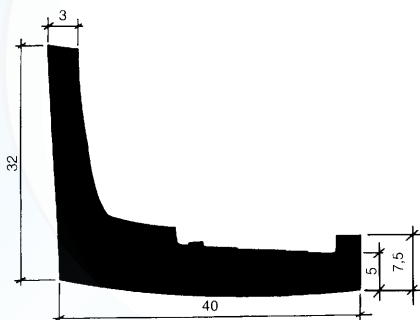

P 1034 gr./mt. 600 60 Sh

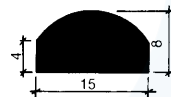

P 1035 gr./mt. 130 70 Sh

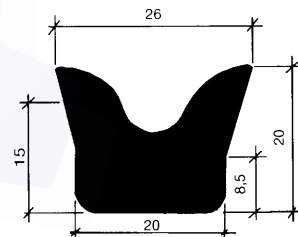

P 1036 gr./mt. 444 70 Sh

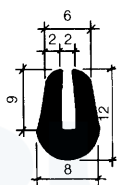

P 1037 gr./mt. 80 60 Sh

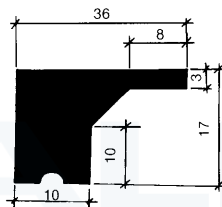

P 1038 gr./mt. 285 60 Sh

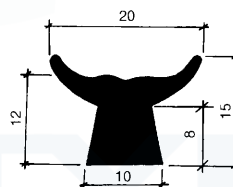

P 1039 gr./mt. 170 60 Sh

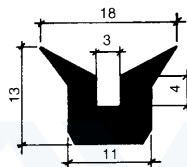

P 1040 gr./mt. 138 40 Sh

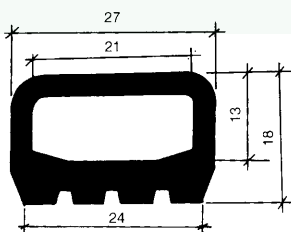

P 1041 gr./mt. 302 50 Sh

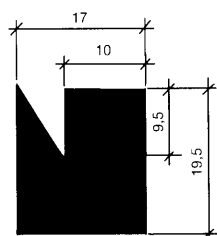

P 1042 gr./mt. 360 60 Sh

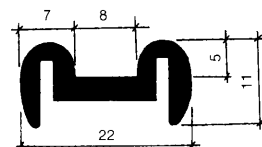

P 1043 gr./mt. 142 70 Sh

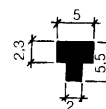

P 1044 gr./mt. 18 70 Sh

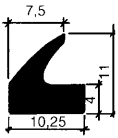

4,6

P 1045 gr./mt. 75 60 Sh

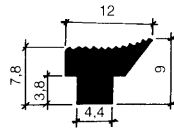

P 1046 gr./mt. 73 70 Sh

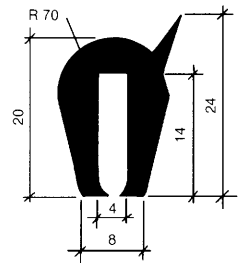

P 1047 gr./mt. 200 60 Sh

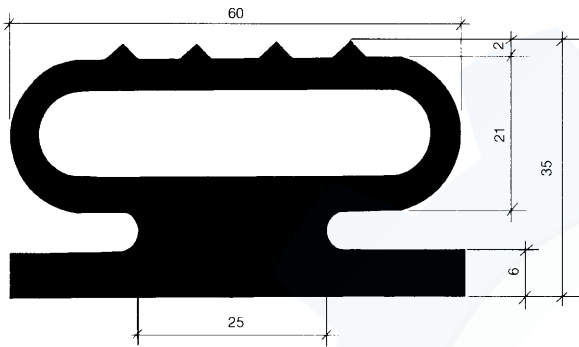

P 1048 gr./mt. 1360 50 Sh

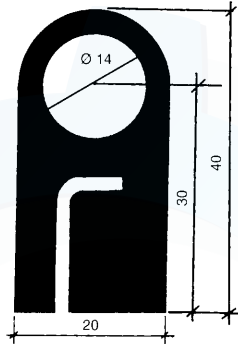

P 1049 gr./mt. 650 50 Sh

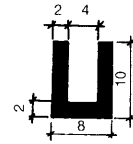

P 1050 gr./mt. 57 60 Sh

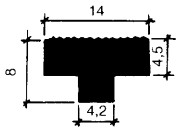

P 1051 gr./mt. 106 70 Sh

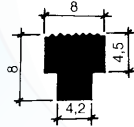

P 1052 gr./mt. 68 70 Sh

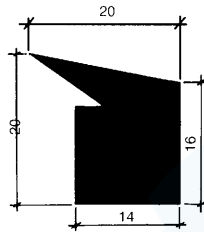

P 1053 gr./mt. 310 60 Sh

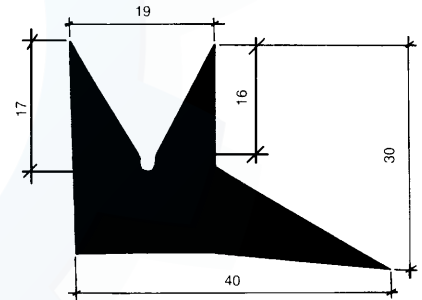

P 1054 gr./mt. 733 60 Sh

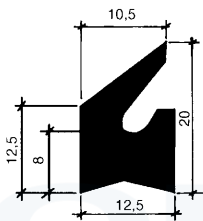

P 1055 gr./mt. 196 60 Sh

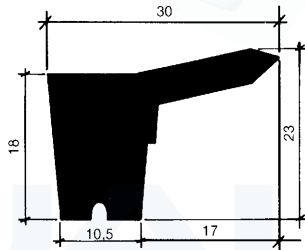

P 1056 gr./mt. 334 70 Sh

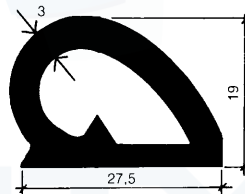

P 1057 gr./mt. 280 60 Sh



P 1058 gr./mt. 302 70 Sh

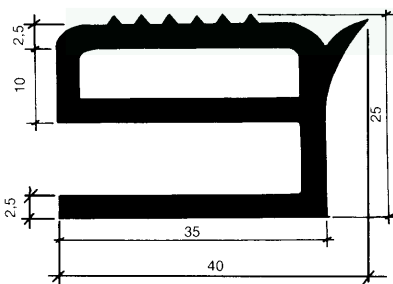

P 1059 gr./mt. 433 60 Sh

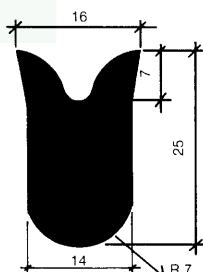

P 1060 gr./mt. 345 60 Sh

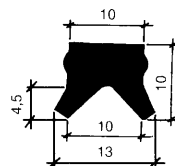

P 1061 gr./mt. 119 60 Sh

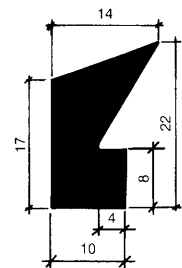

P 1062 gr./mt. 216 60 Sh

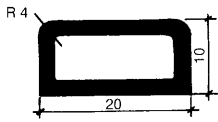

P 1063 gr./mt. 115 60 Sh

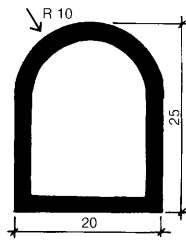

P 1064 gr./mt. 185 60 Sh

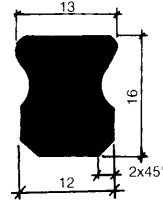

P 1065 gr./mt. 245 70 Sh

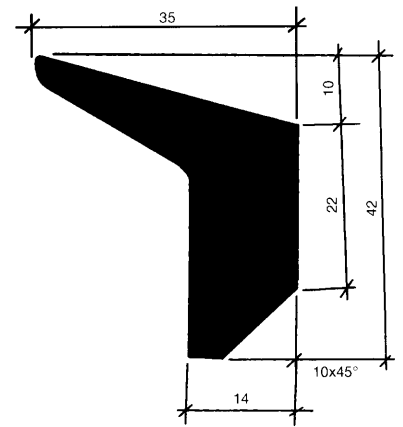

P 1066 gr./mt. 730 50 Sh

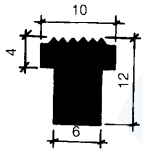

P 1067 gr./mt. 106 70 Sh

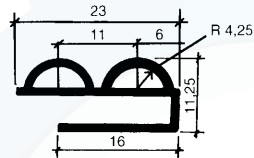

P 1068 gr./mt. 101 60 Sh

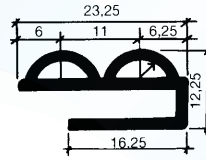

P 1069 gr./mt. 112 60 Sh

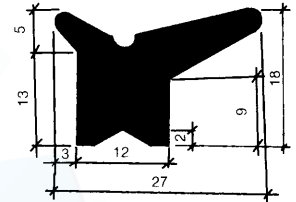

P 1070 gr./mt. 315 70 Sh

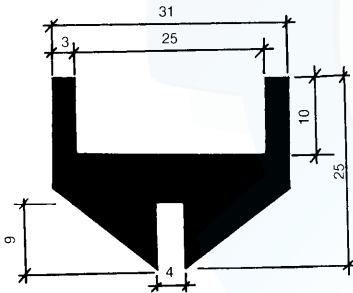

P 1071 gr./mt. 450 50 Sh

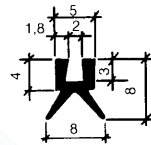

P 1072 gr./mt. 38 60 Sh

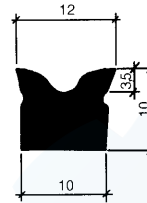

P 1073 gr./mt. 111 50 Sh

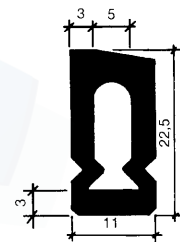

P 1074 gr./mt. 206 70 Sh

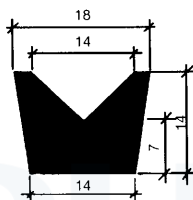

P 1075 gr./mt. 220 70 Sh

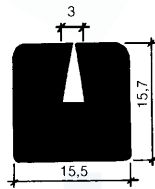

P 1076 gr./mt. 239 50 Sh

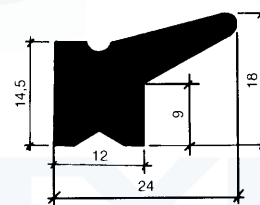

P 1077 gr./mt. 265 70 Sh

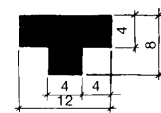

P 1078 gr./mt. 85 70 Sh

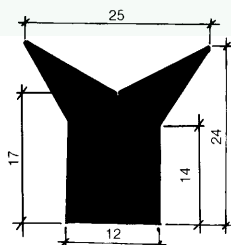

P 1079 gr./mt. 318 50 Sh

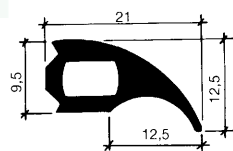

P 1080 gr./mt. 134 70 Sh

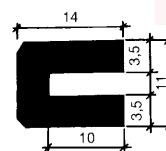

P 1081 gr./mt. 140 60 Sh

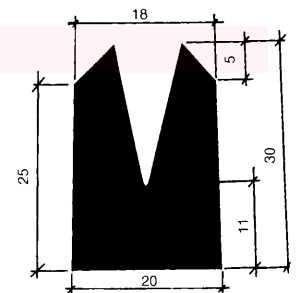

P 1082 gr./mt. 560 70 Sh

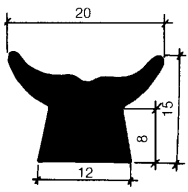

P 1083 gr./mt. 203 60 Sh

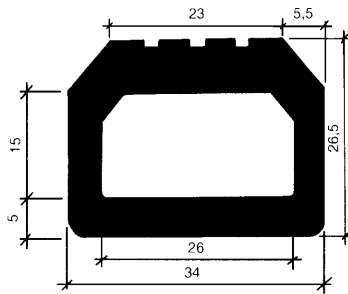

P 1084 gr./mt. 628 60 Sh

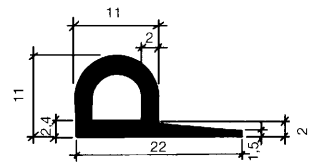

P 1085 gr./mt. 100 60 Sh

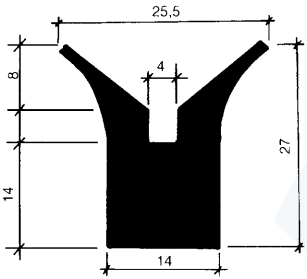

P 1086 gr./mt. 373 70 Sh

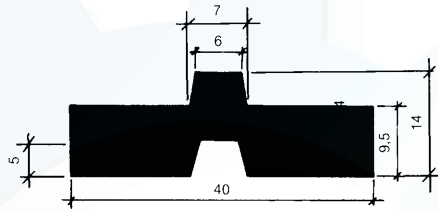

P 1087 gr./mt. 473 60 Sh

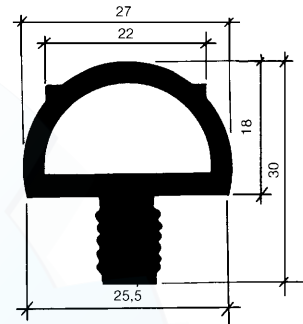

P 1088 gr./mt. 275 60 Sh

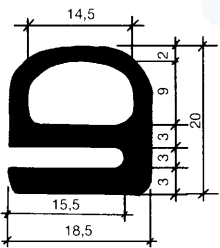

P 1089 gr./mt. 250 70 Sh

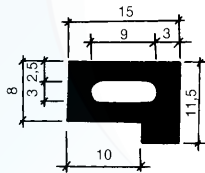

P 1090 gr./mt. 135 60 Sh

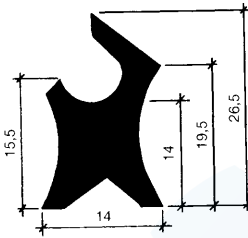

P 1091 gr./mt. 293 70 Sh

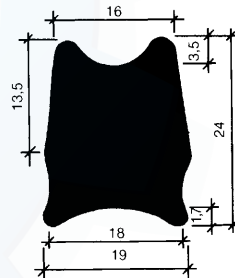

P 1092 gr./mt. 475 60 Sh

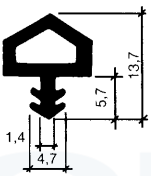

P 1093 gr./mt. 59 60 Sh

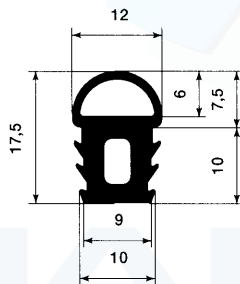

P 1094 gr./mt. 140 60 Sh

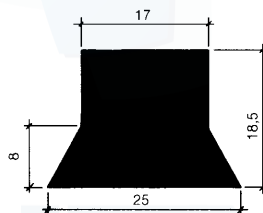

P 1095 gr./mt. 590 50 Sh

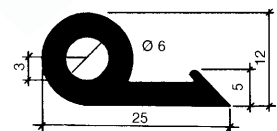

P 1096 gr./mt. 163 60 Sh

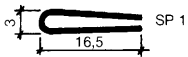

P 1097 gr./mt. 40 50 Sh

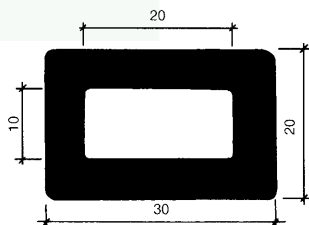

P 1098 gr./mt. 471 50 Sh

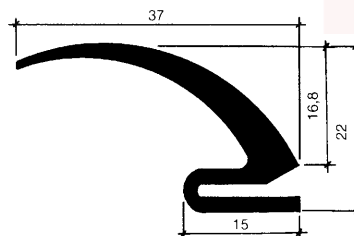

P 1099 gr./mt. 204 70 Sh

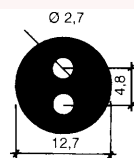

P 1100 gr./mt. 153 70 Sh

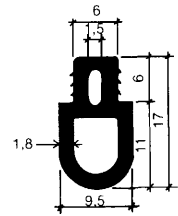
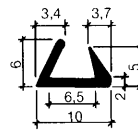
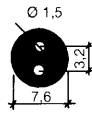
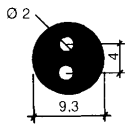

P 1101 gr./mt. 87 70 Sh

P 1102 gr./mt. 56 70 Sh

P 1103 gr./mt. 31 70 Sh

P 1104 gr./mt. 107 50 Sh

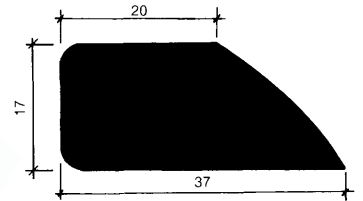
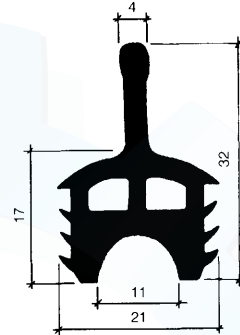
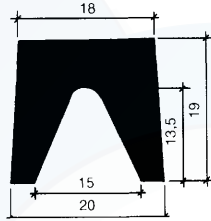
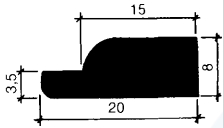

P 1105 gr./mt. 178 60 Sh

P 1106 gr./mt. 320 50 Sh

P 1107 gr./mt. 313 55 Sh

P 1108 gr./mt. 646 50 Sh

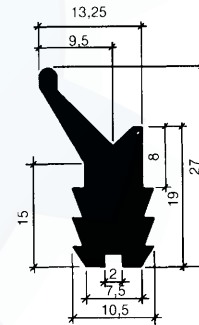
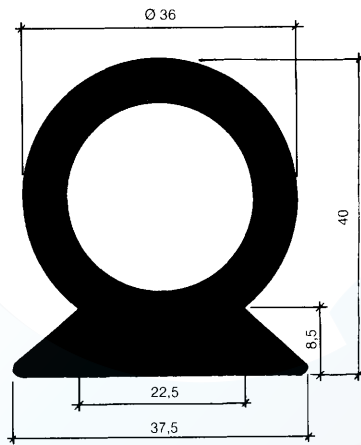
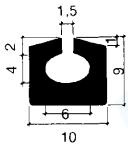

P 1109 gr./mt. 74 50 Sh

P 1110 gr./mt. 780 60 Sh

P 1111 gr./mt. 222 40 Sh

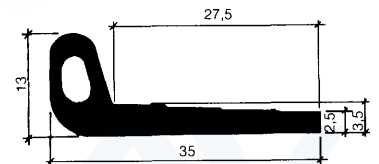
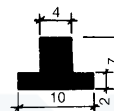
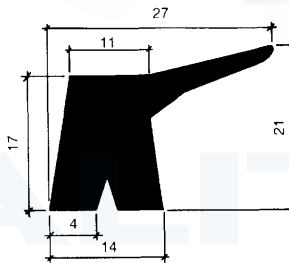
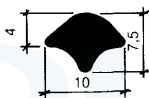

P 1112 gr./mt. 71 80 Sh

P 1113 gr./mt. 303 50 Sh

P 1114 gr./mt. 46 50 Sh

P 1115 gr./mt. 175 60 Sh

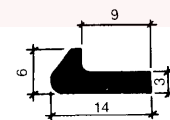
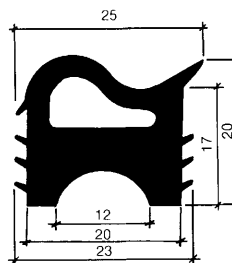
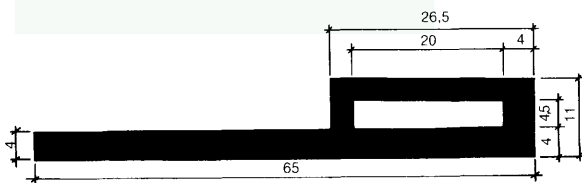

P 1116 gr./mt. 451 60 Sh

P 1117 gr./mt. 260 55 Sh

P 1118 gr./mt. 59 60 Sh

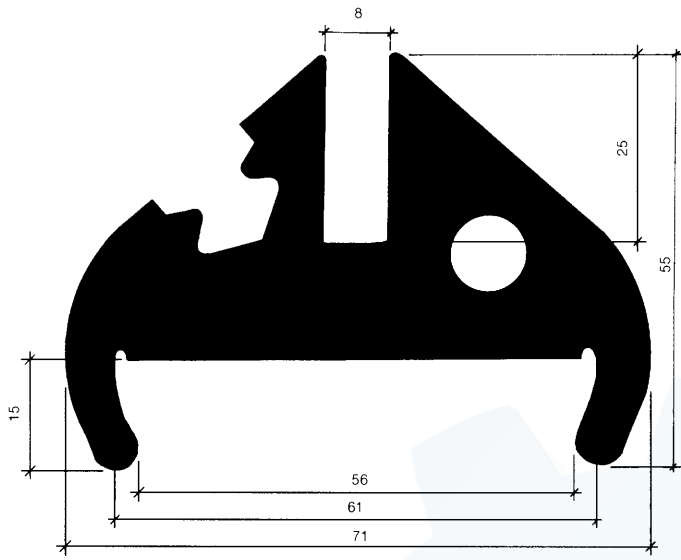

P 1119 gr./mt. 1800 60 Sh

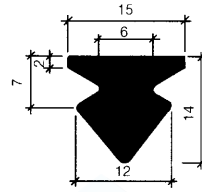

P 1120 gr./mt. 150 60 Sh

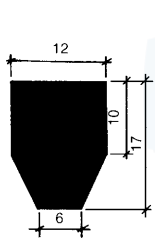

P 1121 gr./mt. 203 30 Sh

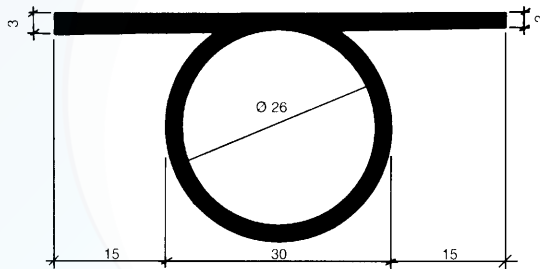

P 1122 gr./mt. 359 60 Sh

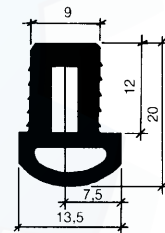

P 1123 gr./mt. 200 50 Sh

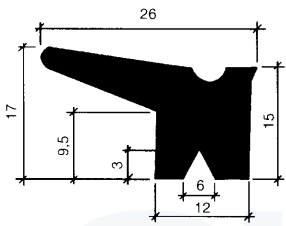

P 1124 gr./mt. 285 50 Sh

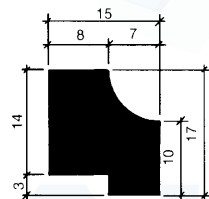

P 1125 gr./mt. 238 60 Sh

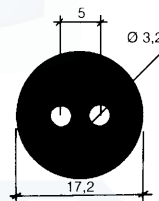

P 1126 gr./mt. 288 75 Sh

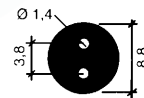

P 1127 gr./mt. 77 75 Sh

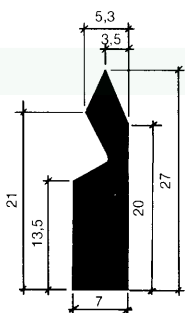

P 1128 gr./mt. 186 75 Sh

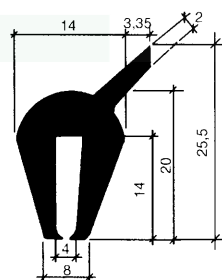

P 1129 gr./mt. 217 60 Sh

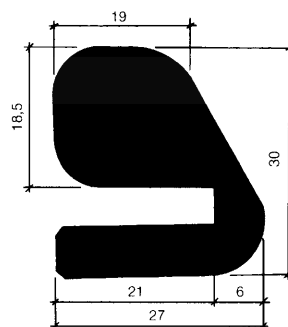

P 1130 gr./mt. 654 45 Sh

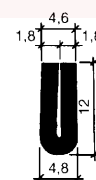

P 1131 gr./mt. 60 60 Sh

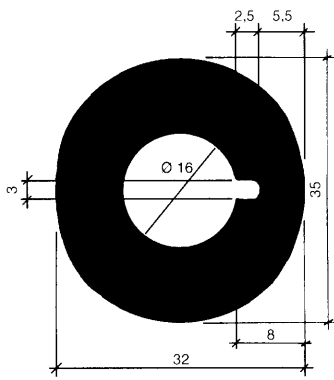

P 1132 gr./mt. 820 45 Sh

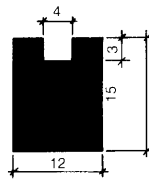

P 1133 gr./mt. 217 60 Sh

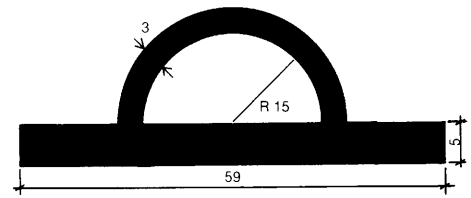

P 1134 gr./mt. 506 60 Sh

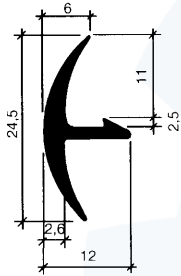

P 1135 gr./mt. 107 70 Sh

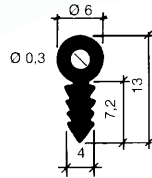

P 1136 gr./mt. 51 60 Sh

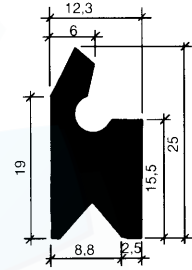

P 1137 gr./mt. 245 60 Sh

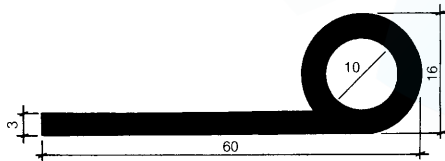

P 1138 gr./mt. 330 60 Sh

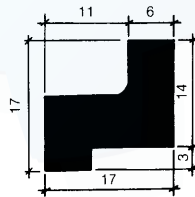

P 1139 gr./mt. 211 60 Sh

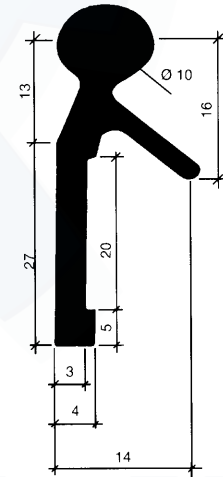

P 1140 gr./mt. 324 50 Sh

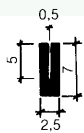

P 1141 gr./mt. 20 60 Sh

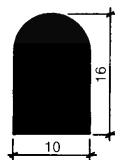

P 1142 gr./mt. 176 30 Sh

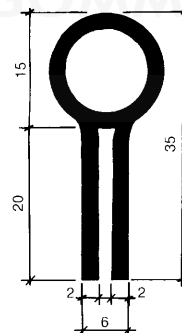

P 1143 gr./mt. 201 60 Sh

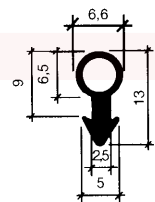

P 1144 gr./mt. 38 50 Sh

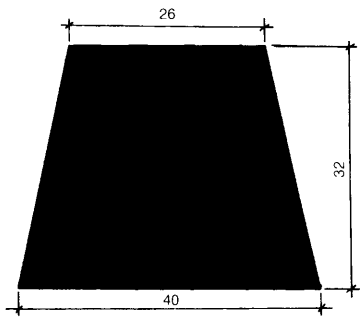

P 1145 gr./mt. 1195 40 Sh

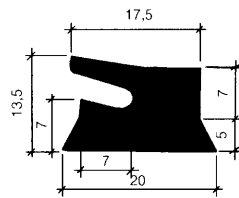

P 1146 gr./mt. 252 70 Sh

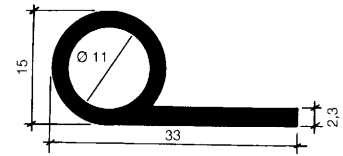

P 1147 gr./mt. 156 60 Sh

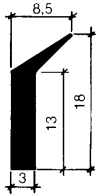

P 1148 gr./mt. 64 50 Sh

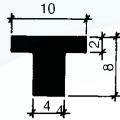

P 1149 gr./mt. 57 60 Sh

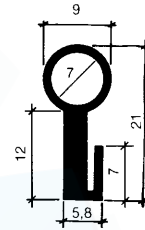

P 1150 gr./mt. 89 60 Sh

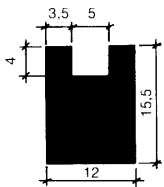

P 1151 gr./mt. 210 60 Sh

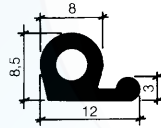

P 1152 gr./mt. 73 60 Sh

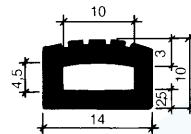

P 1153 gr./mt. 117 60 Sh

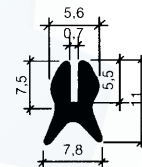

P 1154 gr./mt. 56 50 Sh

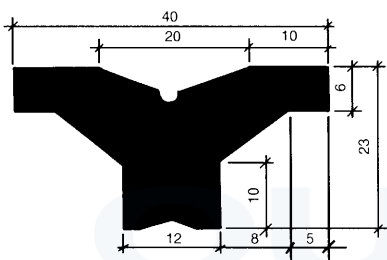

P 1155 gr./mt. 600 60 Sh

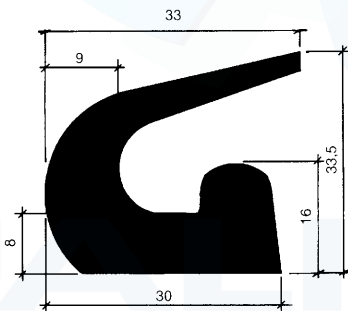

P 1156 gr./mt. 685 55 Sh

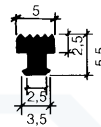

P 1157 gr./mt. 25 60 Sh

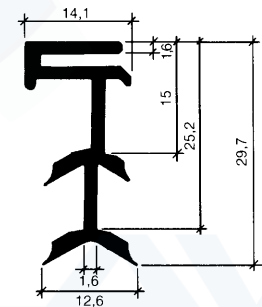

P 1158 gr./mt. 167 60 Sh

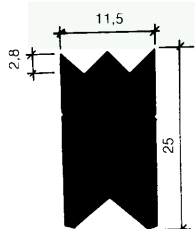

P 1159 gr./mt. 310 65 Sh

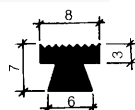

P 1160 gr./mt. 54 60 Sh

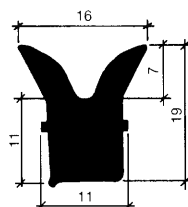

P 1161 gr./mt. 193 75 Sh

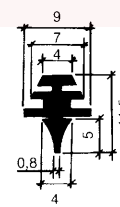

P 1162 gr./mt. 44 60 Sh

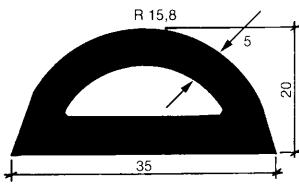

P 1163 gr./mt. 465 70 Sh

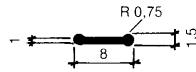

P 1164 gr./mt. 12 50 Sh

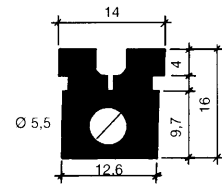

P 1165 gr./mt. 200 70 Sh

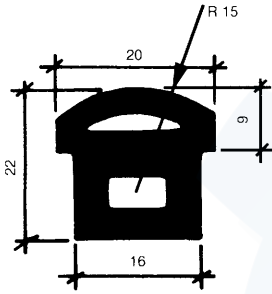

P 1166 gr./mt. 308 50 Sh

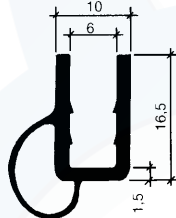

P 1167 gr./mt. 133 60 Sh

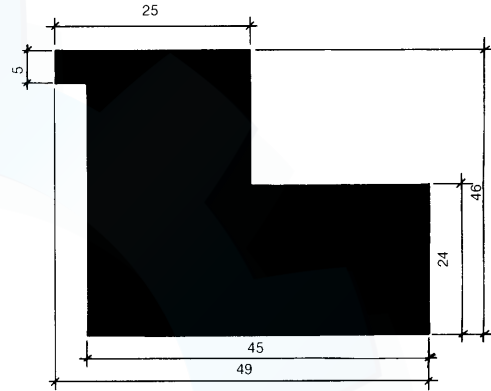

P 1168 gr./mt. 1400 70 Sh

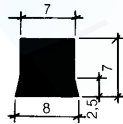

P 1169 gr./mt. 66 60 Sh

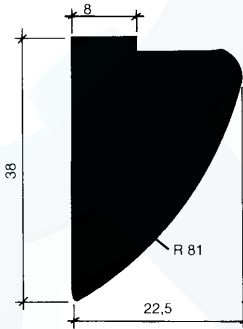

P 1170 gr./mt. 600 70 Sh

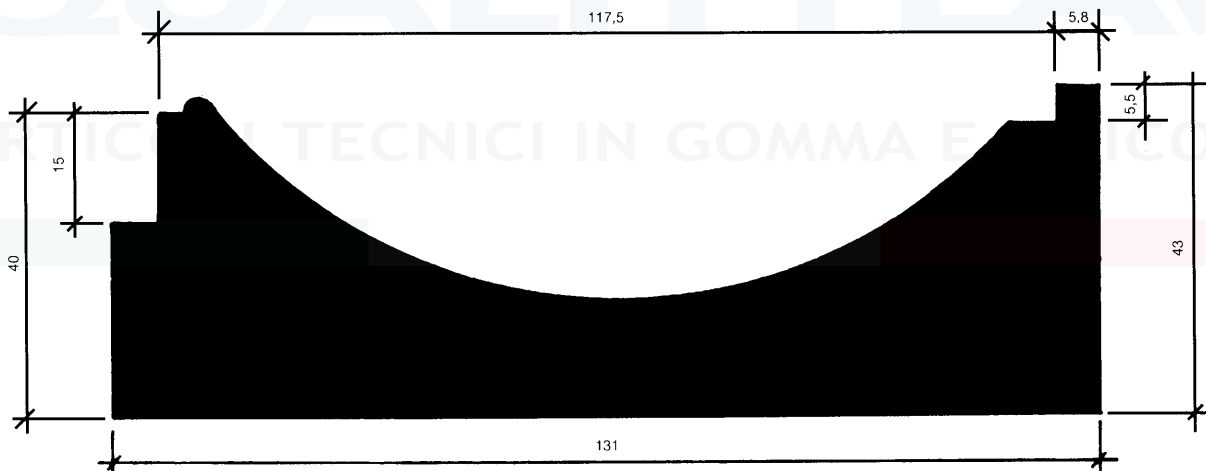

P 1171 gr./mt. 4000 70 Sh

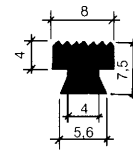
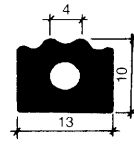
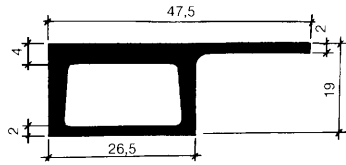
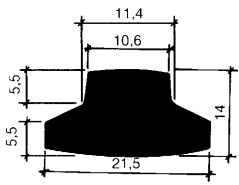

P 1172 gr./mt. 280 70 Sh

P 1173 gr./mt. 320 60 Sh

P 1174 gr./mt. 121 50 Sh

P 1175 gr./mt. 58 70 Sh

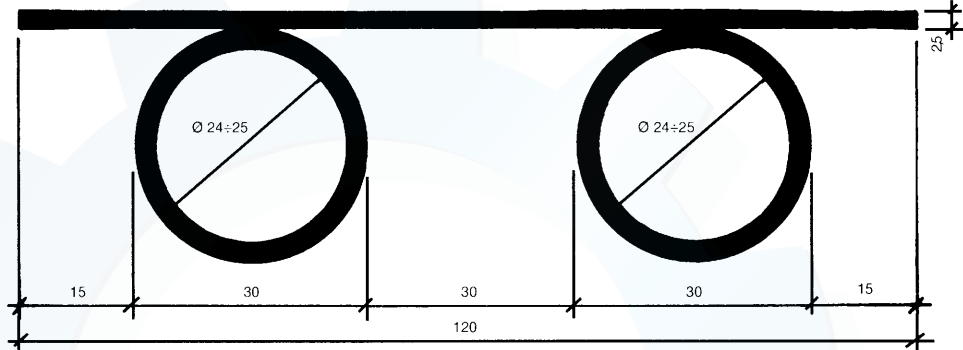
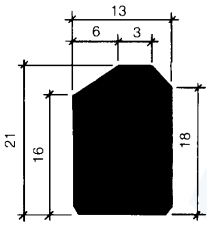

P 1176 gr./mt. 324 50 Sh

P 1177 gr./mt. 893 60 Sh

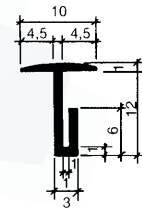
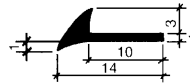
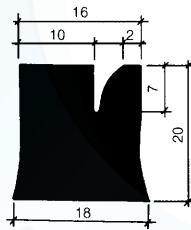
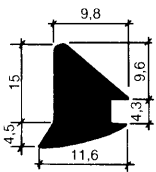

P 1178 gr./mt. 135 50 Sh

P 1179 gr./mt. 425 60 Sh

P 1180 gr./mt. 28 60 Sh

P 1181 gr./mt. 37 60 Sh

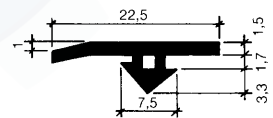
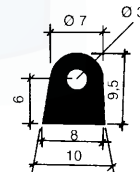
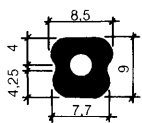

P 1182 gr./mt. 49 60 Sh

P 1183 gr./mt. 18 70 Sh

P 1184 gr./mt. 75 60 Sh

P 1185 gr./mt. 80 60 Sh

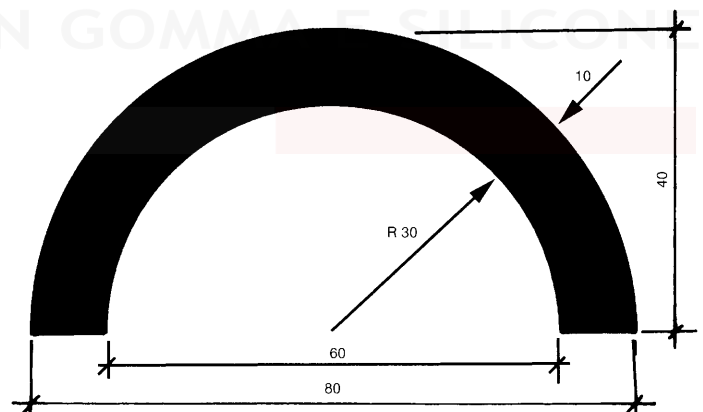
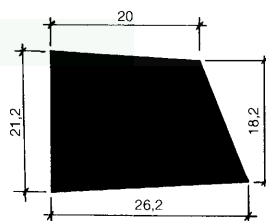
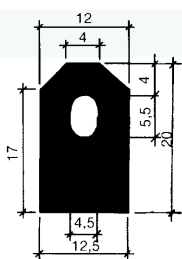

P 1186 gr./mt. 260 40 Sh

P 1187 gr./mt. 550 50 Sh

P 1188 gr./mt. 1650 60 Sh

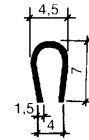
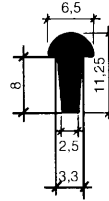
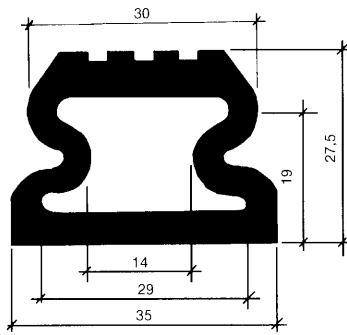
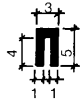

P 1189 gr./mt. 16 60 Sh

P 1190 gr./mt. 530 50 Sh

P 1191 gr./mt. 50 60 Sh

P 1192 gr./mt. 26 70 Sh

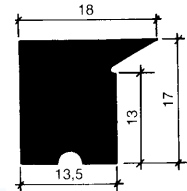
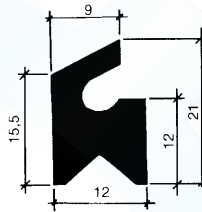
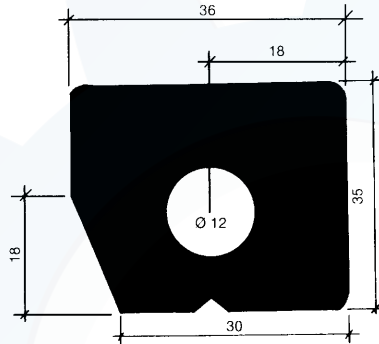
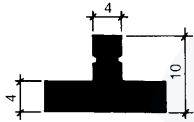

P 1193 gr./mt. 114 60 Sh

P 1194 gr./mt. 1390 70 Sh

P 1195 gr./mt. 197 70 Sh

P 1196 gr./mt. 283 60 Sh

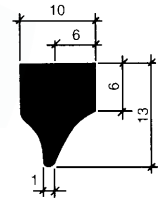
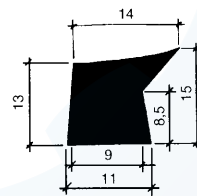
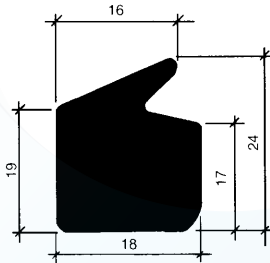
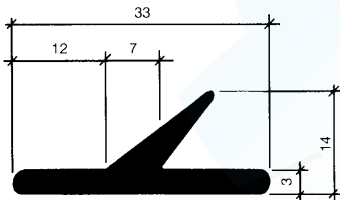

P 1197 gr./mt. 175 60 Sh

P 1198 gr./mt. 460 60 Sh

P 1199 gr./mt. 180 60 Sh

P 1200 gr./mt. 108 40 Sh

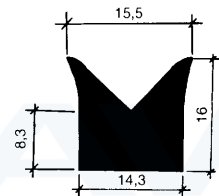
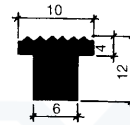
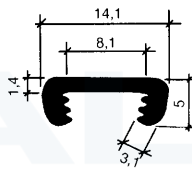
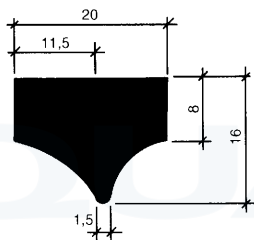

P 1201 gr./mt. 253 40 Sh

P 1202 gr./mt. 46 40 Sh

P 1203 gr./mt. 108 60 Sh

P 1204 gr./mt. 227 60 Sh

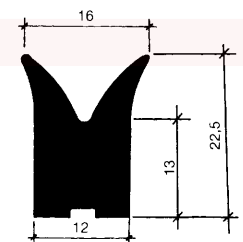
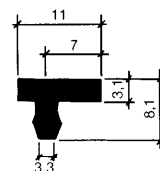
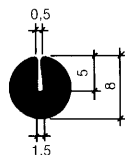
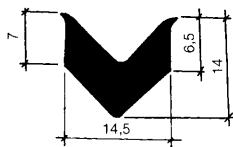

P 1205 gr./mt. 151 60 Sh

P 1206 gr./mt. 60 70 Sh

P 1207 gr./mt. 63 80 Sh

P 1208 gr./mt. 276 50 Sh

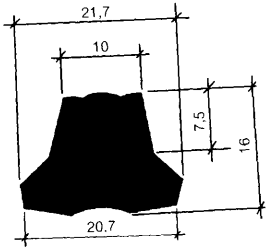

P 1209 gr./mt. 310 50 Sh

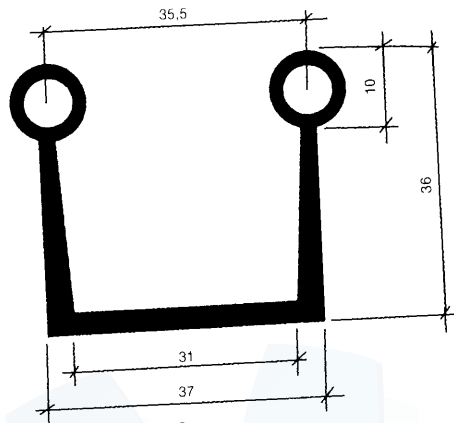

P 1210 gr./mt. 400 50 Sh

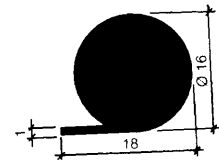

P 1211 gr./mt. 260 60 Sh



P 1212 gr./mt. 108 60 Sh

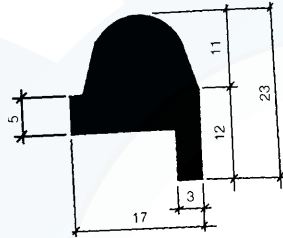

P 1213 gr./mt. 500 40 Sh

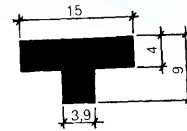

P 1214 gr./mt. 100 70 Sh

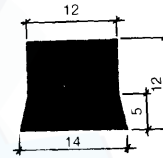

P 1215 gr./mt. 196 60 Sh

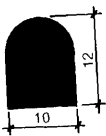

P 1216 gr./mt. 140 60 Sh

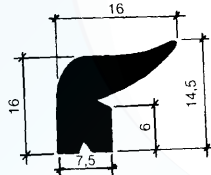

P 1217 gr./mt. 150 60 Sh

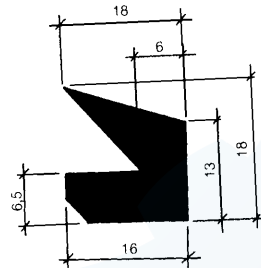

P 1218 gr./mt. 257 60 Sh

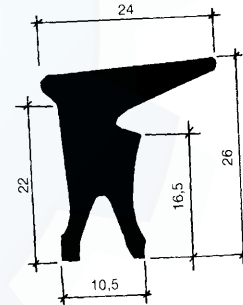

P 1219 gr./mt. 345 60 Sh

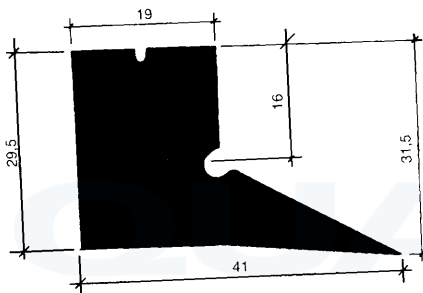

P 1220 gr./mt. 876 60 Sh

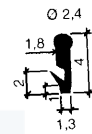

P 1221 gr./mt. 11 60 Sh

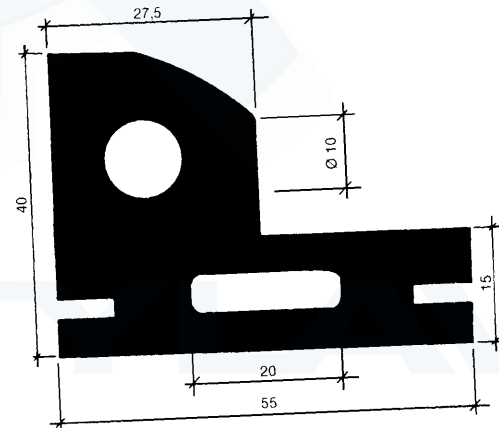

P 1222 gr./mt. 1600 50 Sh

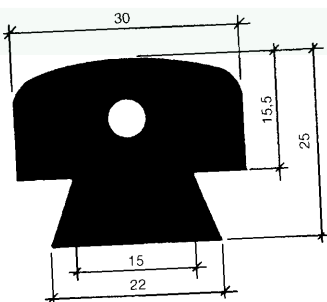

P 1223 gr./mt. 760 60 Sh

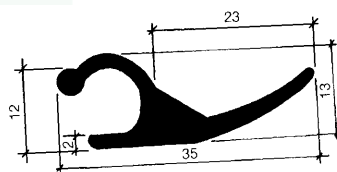

P 1224 gr./mt. 200 50 Sh

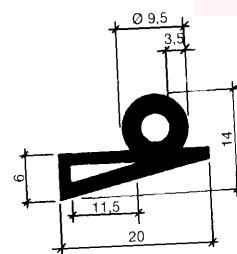

P 1225 gr./mt. 135 60 Sh

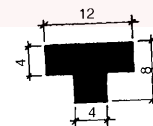

P 1226 gr./mt. 85 75 Sh

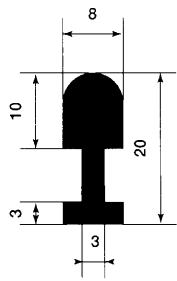

P 1227 gr./mt. 168 60 Sh

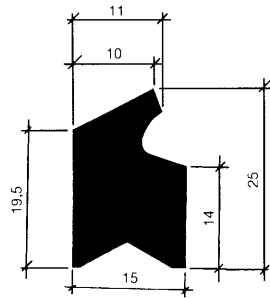

P 1228 gr./mt. 327 50 Sh

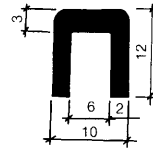

P 1229 gr./mt. 80 60 Sh

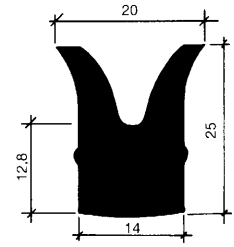

P 1230 gr./mt. 362 65 Sh

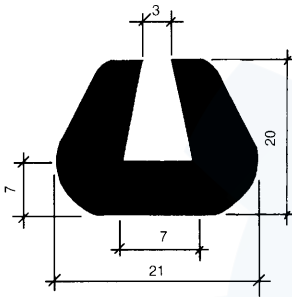

P 1231 gr./mt. 296 60 Sh

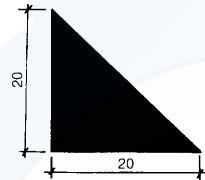

P 1232 gr./mt. 290 60 Sh

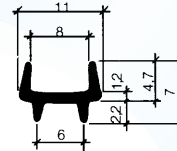

P 1233 gr./mt. 30 50 Sh

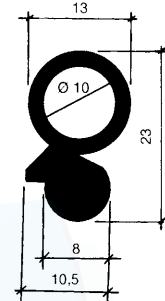

P 1234 gr./mt. 92 70 Sh

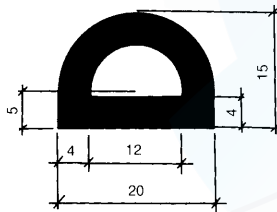

P 1235 gr./mt. 219 45 Sh

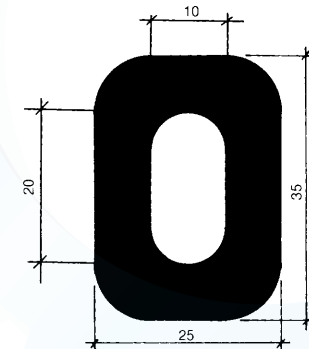

P 1236 gr./mt. 750 60 Sh

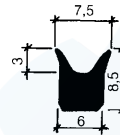

P 1237 gr./mt. 52 60 Sh

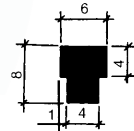

P 1238 gr./mt. 55 75 Sh

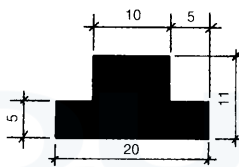

P 1239 gr./mt. 192 60 Sh

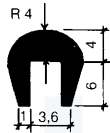

P 1240 gr./mt. 57 50 Sh

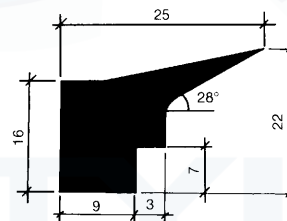

P 1241 gr./mt. 269 60 Sh

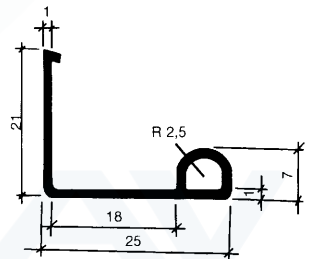

P 1242 gr./mt. 80 60 Sh

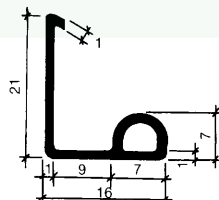

P 1243 gr./mt. 70 60 Sh

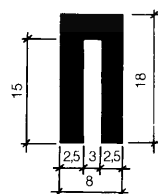

P 1244 gr./mt. 118 65 Sh

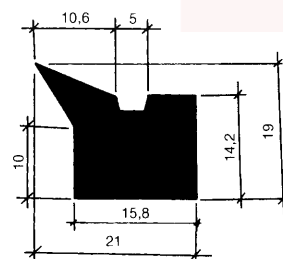

P 1245 gr./mt. 326 60 Sh

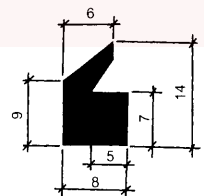

P 1246 gr./mt. 91 35 Sh

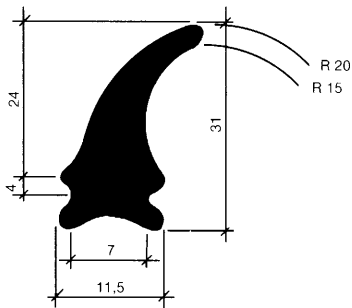

P 1247 gr./mt. 240 60 Sh

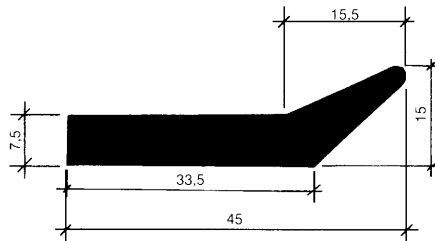

P 1248 gr./mt. 415 60 Sh

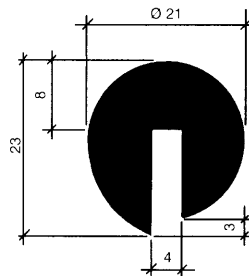

P 1249 gr./mt. 368 60 Sh

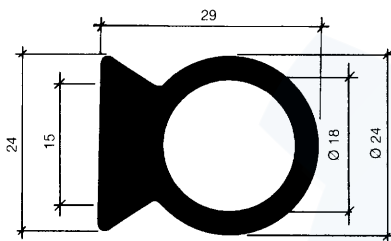

P 1250 gr./mt. 413 60 Sh

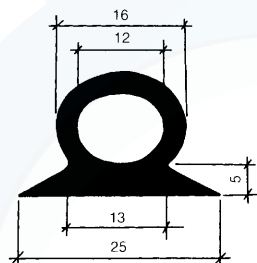

P 1251 gr./mt. 193 60 Sh

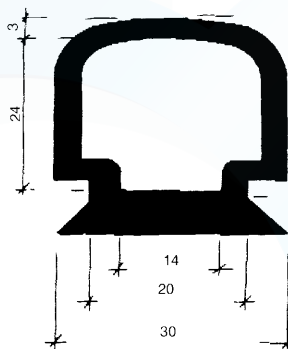

P 1252 gr./mt. 520 55 Sh

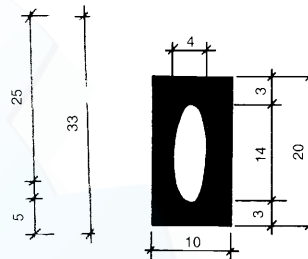

P 1253 gr./mt. 200 55 Sh

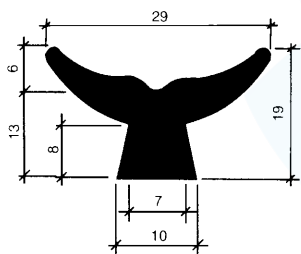

P 1254 gr./mt. 302 60 Sh



P 1255 gr./mt. 307 50 Sh



P 1256 gr./mt. 344 60 Sh

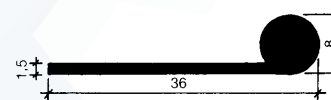

P 1257 gr./mt. 120 60 Sh

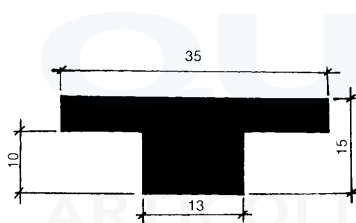

P 1258 gr./mt. 350 60 Sh

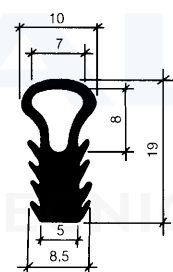

P 1259 gr./mt. 144 60 Sh

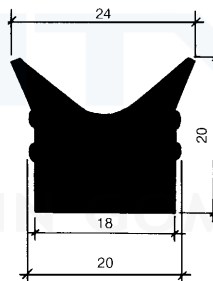

P 1260 gr./mt. 371 60 Sh

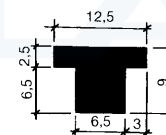

P 1261 gr./mt. 92 70 Sh

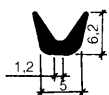

P 1262 gr./mt. 27 60 Sh

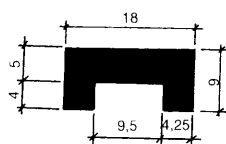

P 1263 gr./mt. 159 50 Sh

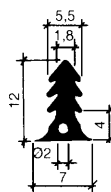

P 1264 gr./mt. 47 60 Sh

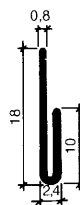

P 1265 gr./mt. 30 60 Sh

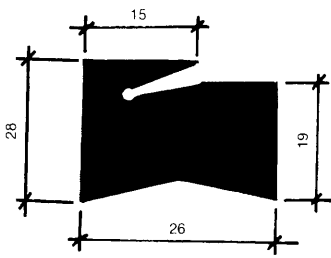

P 1266 gr./mt. 650 60 Sh

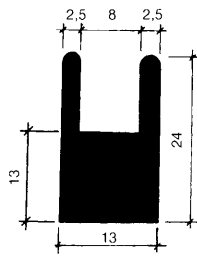

P 1267 gr./mt. 285 75 Sh

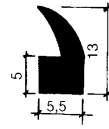

P 1268 gr./mt. 54 40 Sh

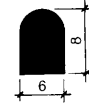

P 1269 gr./mt. 60 50 Sh

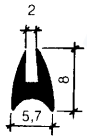

P 1270 gr./mt. 44 60 Sh

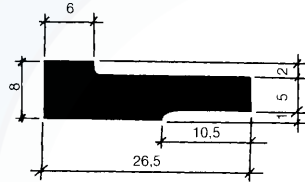

P 1271 gr./mt. 197 60 Sh

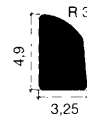

P 1272 gr./mt. 17 75 Sh

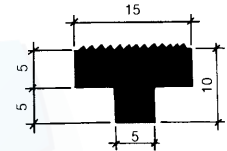

P 1273 gr./mt. 114 60 Sh

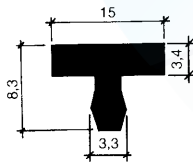

P 1274 gr./mt. 80 75 Sh

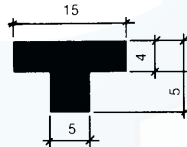

P 1275 gr./mt. 113 50 Sh

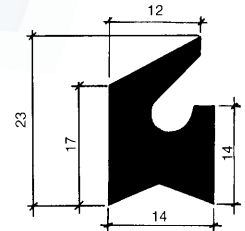

P 1276 gr./mt. 259 60 Sh

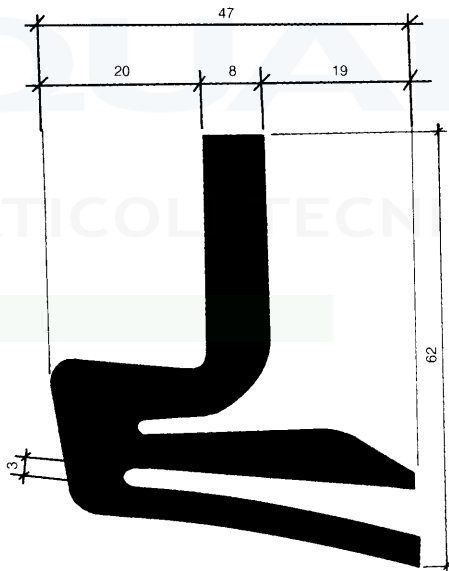

P 1277 gr./mt. 1365 70 Sh

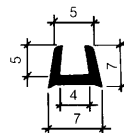

P 1278 gr./mt. 47 50 Sh

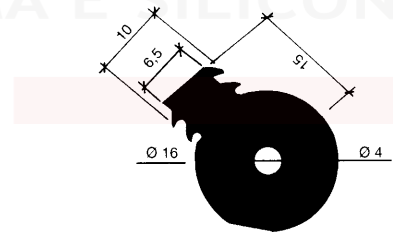

P 1279 gr./mt. 316 60 Sh

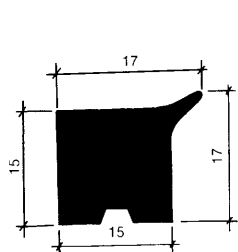

P 1280 gr./mt. 296 60 Sh

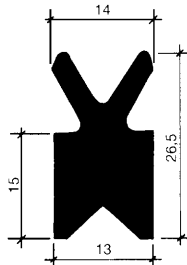

P 1281 gr./mt. 322 70 Sh

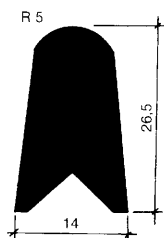

P 1282 gr./mt. 384 70 Sh

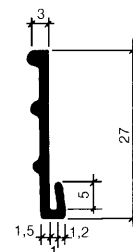

P 1283 gr./mt. 75 60 Sh

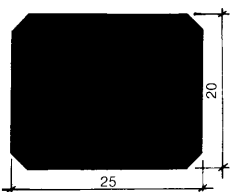

P 1284 gr./mt. 536 50 Sh

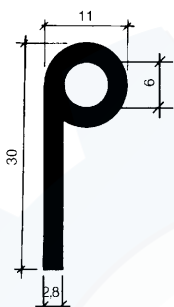

P 1285 gr./mt. 153 60 Sh

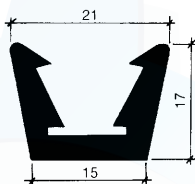

P 1286 gr./mt. 216 70 Sh



P 1287 gr./mt. 105 70 Sh

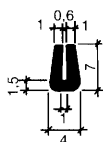

P 1288 gr./mt. 23 40 Sh

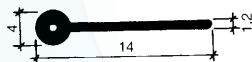

P 1289 gr./mt. 29 60 Sh

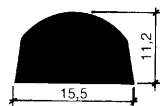

P 1290 gr./mt. 195 60 Sh

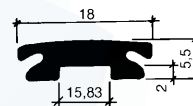

P 1291 gr./mt. 90 60 Sh

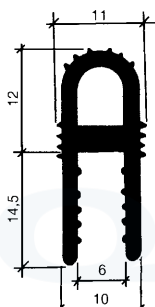

P 1292 gr./mt. 154 70 Sh

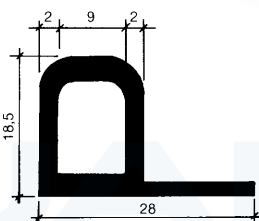

P 1293 gr./mt. 176 70 Sh

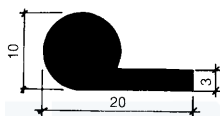

P 1294 gr./mt. 135 50 Sh

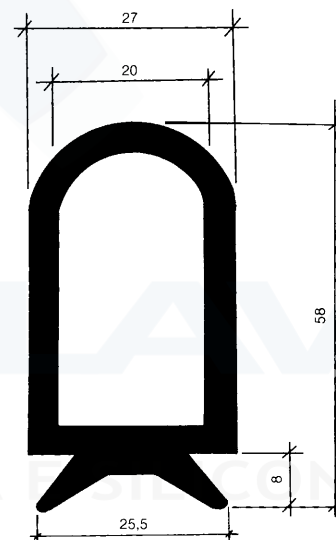

P 1295 gr./mt. 80 65 Sh

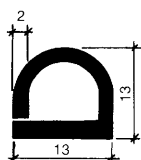

112 P 1296 gr./mt. 98 70 Sh



P 1297 gr./mt. 20 60 Sh

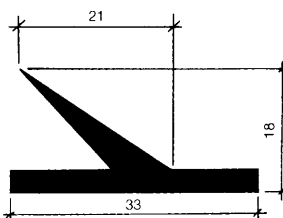

P 1298 gr./mt. 200 60 Sh

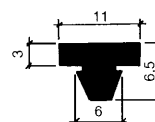

P 1299 gr./mt. 58 60 Sh

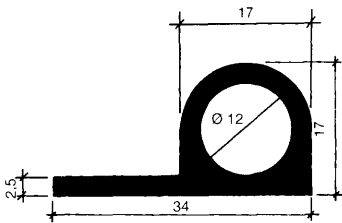

P 1300 gr./mt. 220 60 Sh

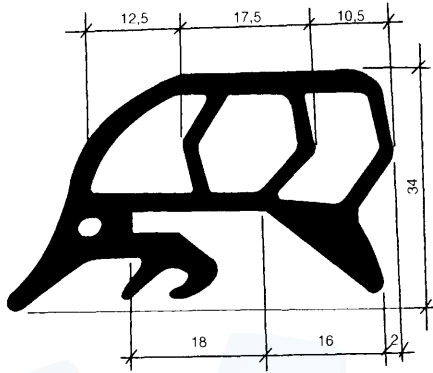

P 1301 gr./mt. 650 60 Sh

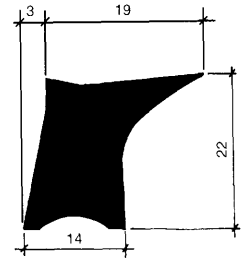

P 1302 gr./mt. 350 60 Sh

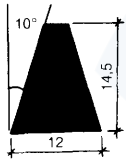

P 1303 gr./mt. 145 60 Sh

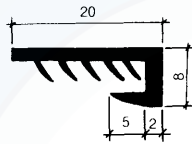

P 1304 gr./mt. 80 60 Sh

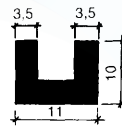

P 1305 gr./mt. 105 60 Sh



P 1306 gr./mt. 8 60 Sh

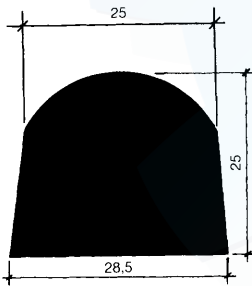

P 1307 gr./mt. 786 65 Sh

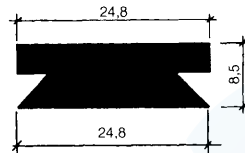

P 1308 gr./mt. 234 60 Sh

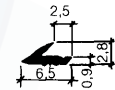

P 1309 gr./mt. 10 75 Sh

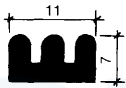

P 1310 gr./mt. 69 40 Sh

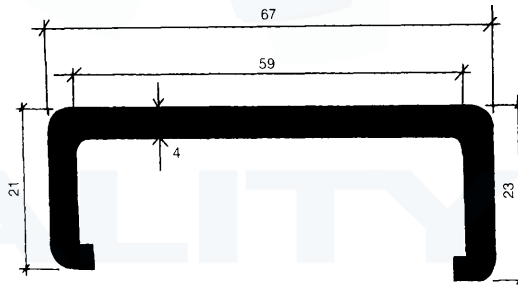

P 1311 gr./mt. 55 70 Sh

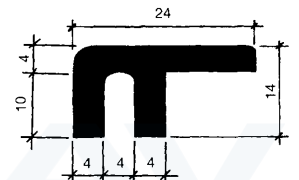

P 1312 gr./mt. 432 70 Sh

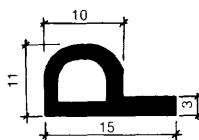

P 1313 gr./mt. 100 60 Sh

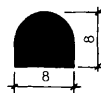

P 1314 gr./mt. 75 40 Sh

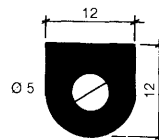

P 1315 gr./mt. 128 60 Sh

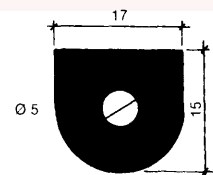

P 1316 gr./mt. 250 60 Sh

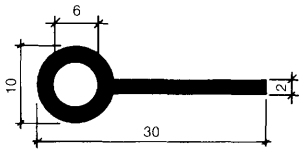

P 1317 gr./mt. 126 50 Sh

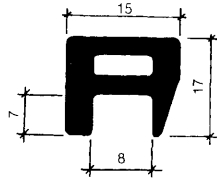

P 1318 gr./mt. 195 60 Sh

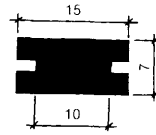

P 1319 gr./mt. 120 60 Sh

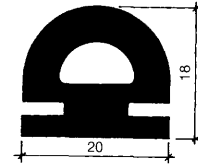

P 1320 gr./mt. 306 60 Sh

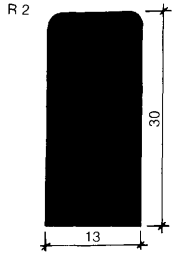

P 1321 gr./mt. 460 60 Sh

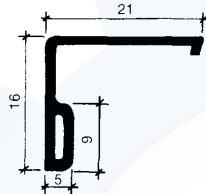

P 1322 gr./mt. 65 60 Sh

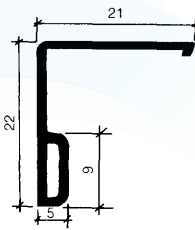

P 1323 gr./mt. 73 60 Sh

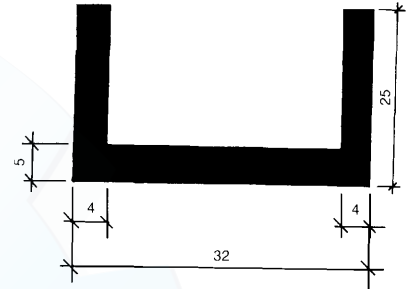

P 1324 gr./mt. 468 60 Sh

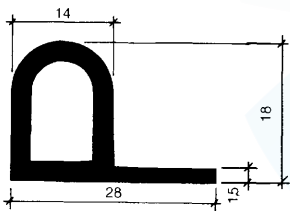

P 1325 gr./mt. 175 60 Sh

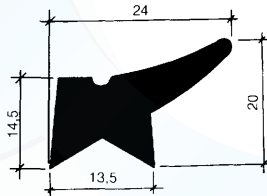

P 1326 gr./mt. 252 65 Sh

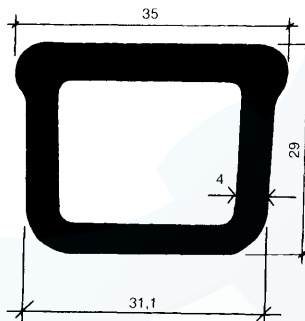

P 1327 gr./mt. 524 60 Sh

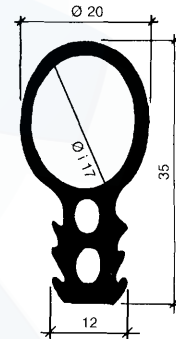

P 1328 gr./mt. 266 60 Sh



P 1329 gr./mt. 177 40 Sh

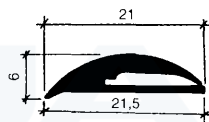

P 1330 gr./mt. 88 60 Sh

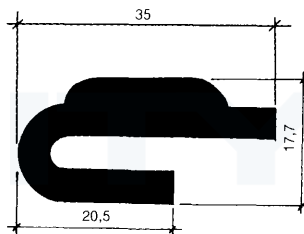

P 1331 gr./mt. 386 50 Sh

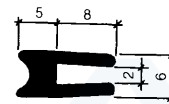

P 1332 gr./mt. 55 60 Sh

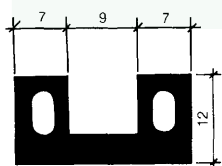

P 1333 gr./mt. 190 35 Sh

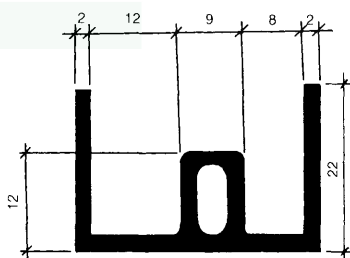

P 1334 gr./mt. 256 50 Sh

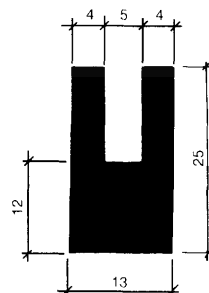

P 1335 gr./mt. 302 60 Sh

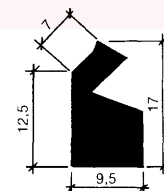

P 1336 gr./mt. 140 55 Sh

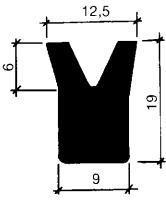

P 1337 gr./mt. 209 70 Sh

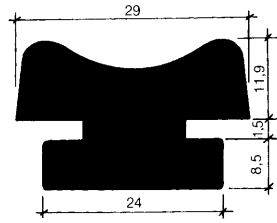

P 1338 gr./mt. 587 60 Sh

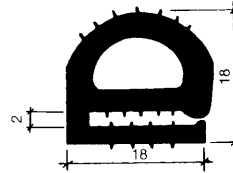

P 1339 gr./mt. 167 45 Sh

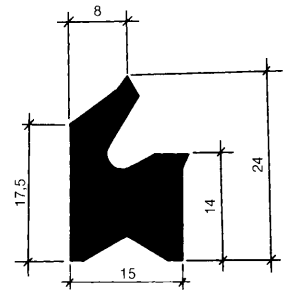

P 1340 gr./mt. 282 650 Sh

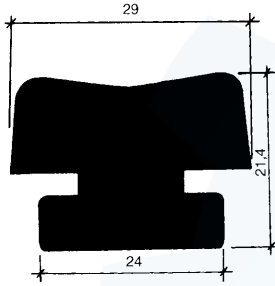

P 1341 gr./mt. 607 75 Sh

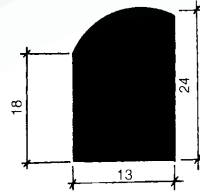

P 1342 gr./mt. 360 60 Sh

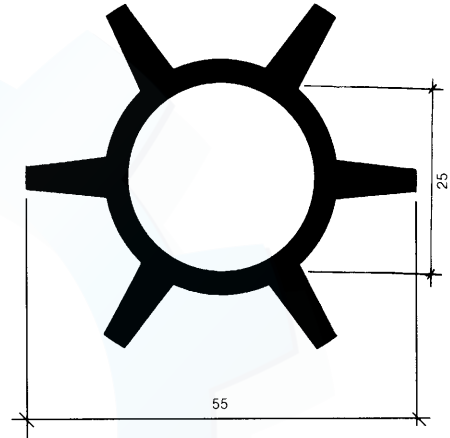

P 1343 gr./mt. 660 60 Sh

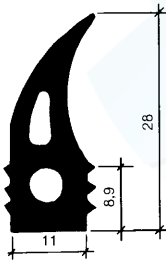

P 1344 gr./mt. 200 50 Sh

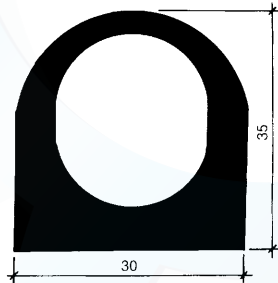

P 1345 gr./mt. 682 70 Sh

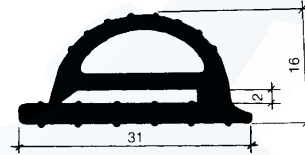

P 1346 gr./mt. 306 60 Sh

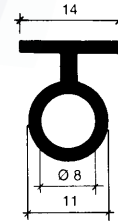

P 1347 gr./mt. 88 60 Sh

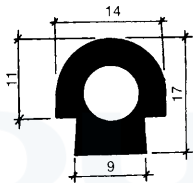

P 1348 gr./mt. 205 60 Sh

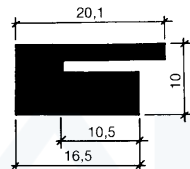

P 1349 gr./mt. 178 50 Sh



P 1350 gr./mt. 332 50 Sh

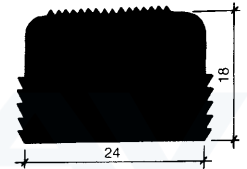

P 1351 gr./mt. 513 50 Sh

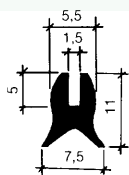

P 1352 gr./mt. 54 70 Sh

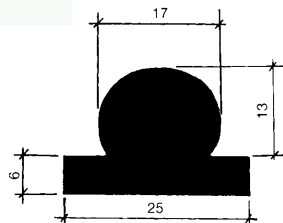

P 1353 gr./mt. 450 60 Sh

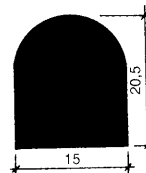

P 1354 gr./mt. 349 60 Sh

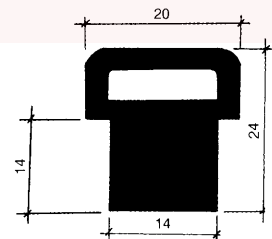

P 1355 gr./mt. 394 60 Sh

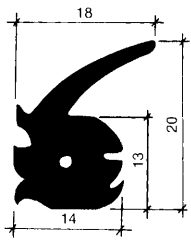

P 1356 gr./mt. 234 60 Sh

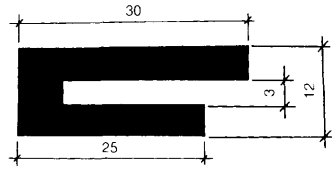

P 1357 gr./mt. 325 50 Sh

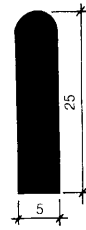

P 1358 gr./mt. 163 60 Sh

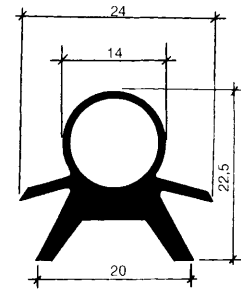

P 1359 gr./mt. 170 50 Sh

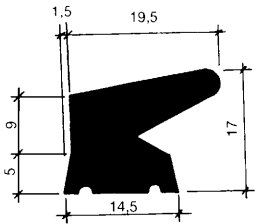

P 1360 gr./mt. 280 70 Sh

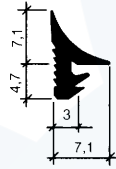

P 1361 gr./mt. 35 70 Sh

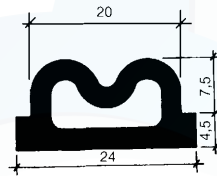

P 1362 gr./mt. 200 60 Sh

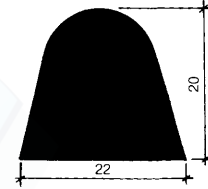

P 1363 gr./mt. 405 60 Sh

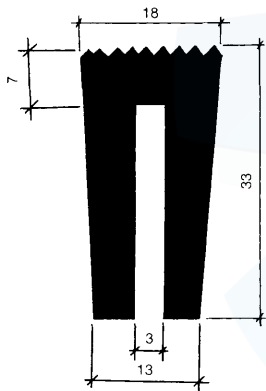

P 1364 gr./mt. 560 70 Sh

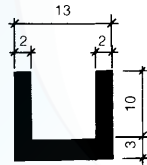

P 1365 gr./mt. 99 60 Sh

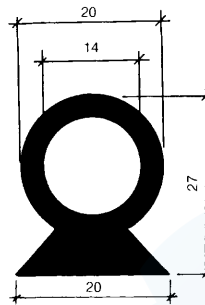

P 1366 gr./mt. 340 60 Sh

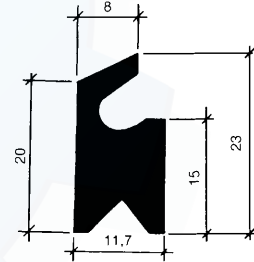

P 1367 gr./mt. 240 70 Sh

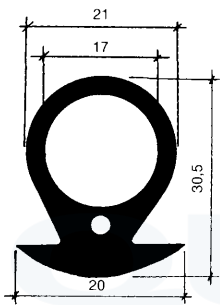

P 1368 gr./mt. 256 70 Sh

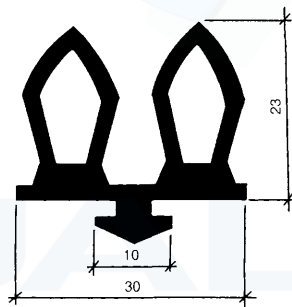

P 1369 gr./mt. 230 55 Sh

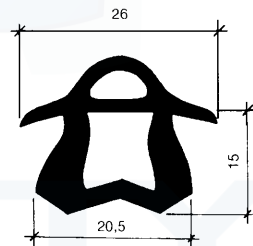

P 1370 gr./mt. 260 50 Sh

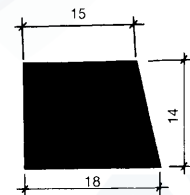

P 1371 gr./mt. 260 40 Sh

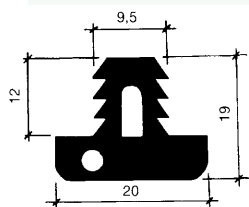

P 1372 gr./mt. 231 50 Sh

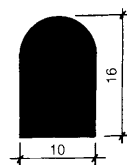

P 1373 gr./mt. 173 40 Sh

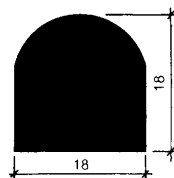

P 1374 gr./mt. 360 50 Sh

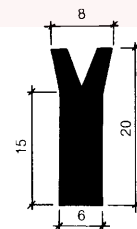

P 1375 gr./mt. 155 60 Sh

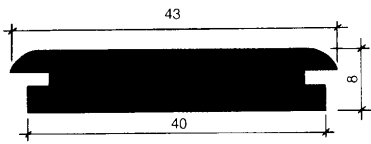

P 1376 gr./mt. 371 60 Sh

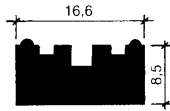

P 1377 gr./mt. 152 60 Sh

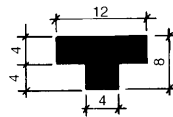

P 1378 gr./mt. 80 75 Sh

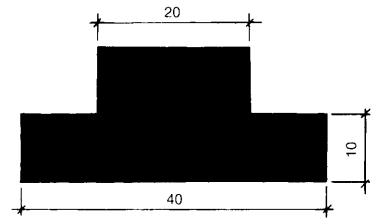

P 1379 gr./mt. 700 60 Sh

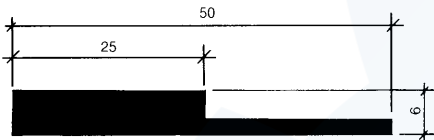

P 1380 gr./mt. 260 60 Sh

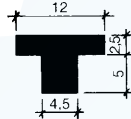

P 1381 gr./mt. 66 70 Sh

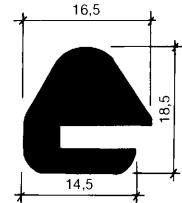

P 1382 gr./mt. 246 60 Sh

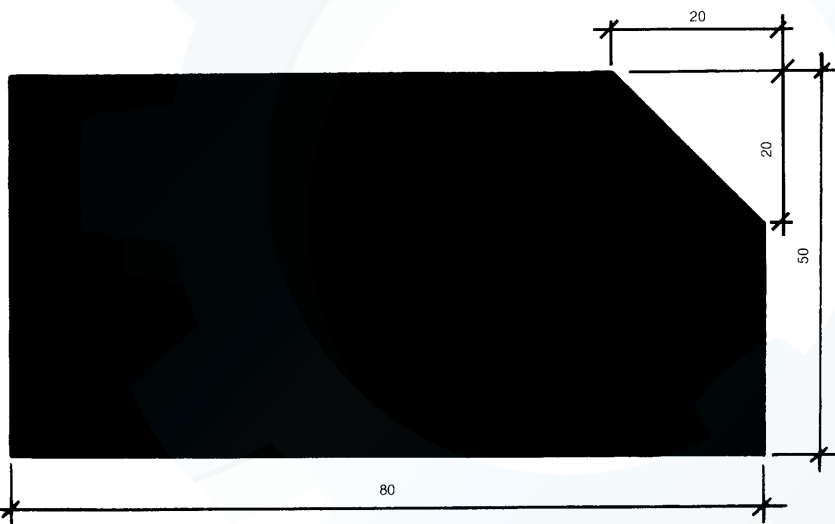

P 1383 gr./mt. 4580 60 Sh

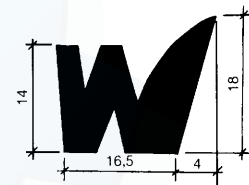

P 1384 gr./mt. 245 60 Sh

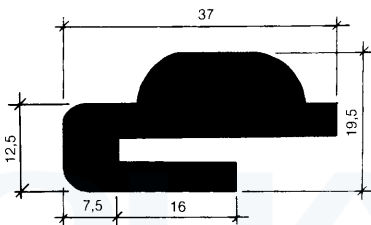

P 1385 gr./mt. 530 50 Sh

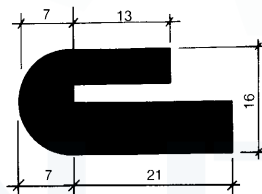

P 1386 gr./mt. 380 50 Sh

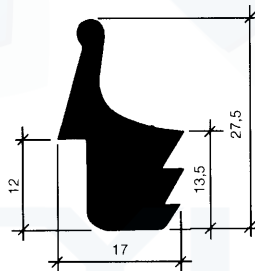

P 1387 gr./mt. 287 70 Sh

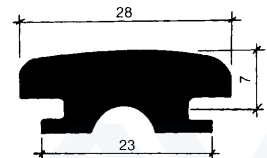

P 1388 gr./mt. 287 70 Sh

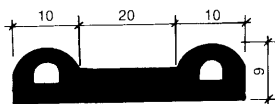

P 1389 gr./mt. 202 60 Sh

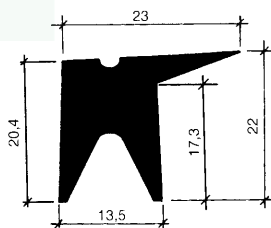

P 1390 gr./mt. 235 50 Sh

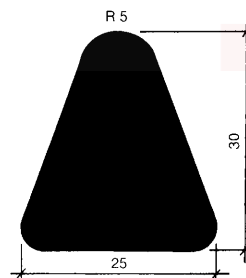

P 1391 gr./mt. 635 45 Sh

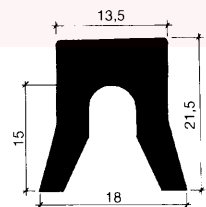

P 1392 gr./mt. 261 75 Sh

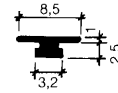
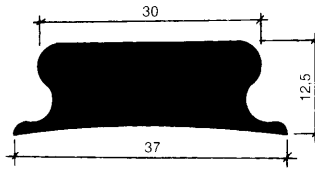
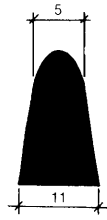

P 1393 gr./mt. 33 55 Sh

P 1394 gr./mt. 156 60 Sh

P 1395 gr./mt. 443 75 Sh

P 1396 gr./mt. 18 50 Sh

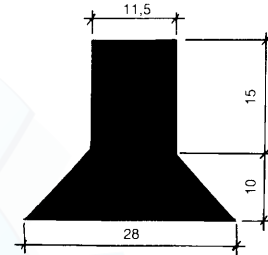
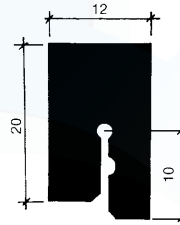
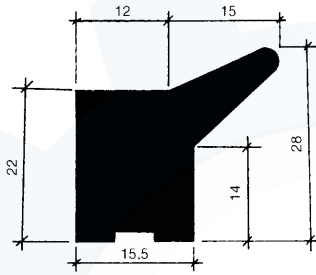
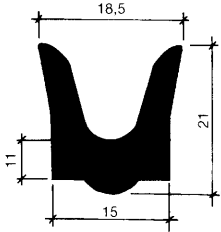

P 1397 gr./mt. 250 65 Sh

P 1398 gr./mt. 520 65 Sh

P 1399 gr./mt. 280 80 Sh

P 1400 gr./mt. 440 40 Sh

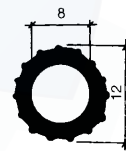
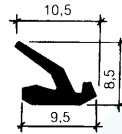
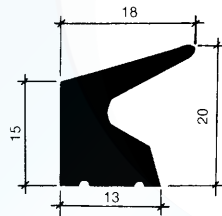
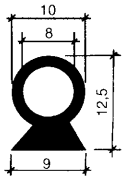

P 1401 gr./mt. 63 70 Sh

P 1402 gr./mt. 218 50 Sh

P 1403 gr./mt. 44 60 Sh

P 1404 gr./mt. 70 60 Sh

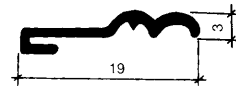
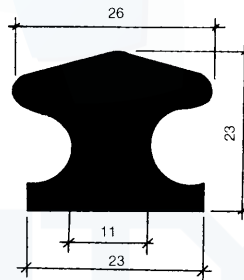
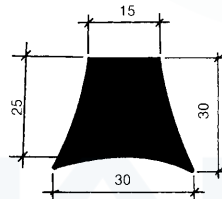
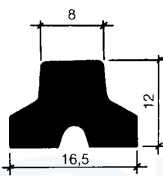

P 1405 gr./mt. 170 65 Sh

P 1406 gr./mt. 684 60 Sh

P 1407 gr./mt. 565 70 Sh

P 1408 gr./mt. 32 60 Sh

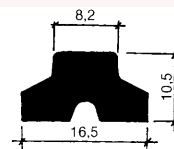
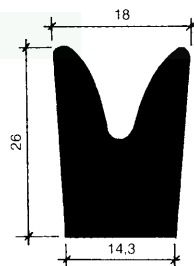
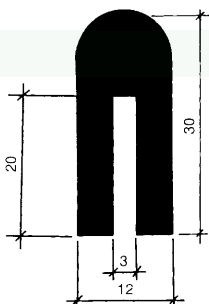

118 P 1409 gr./mt. 360 70 Sh

P 1410 gr./mt. 416 60 Sh

P 1411 gr./mt. 137 50 Sh

P 1412 gr./mt. 155 60 Sh

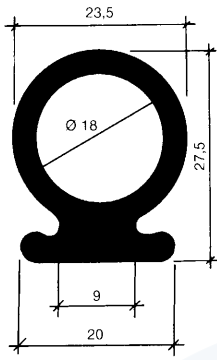

P 1413 gr./mt. 316 65 Sh

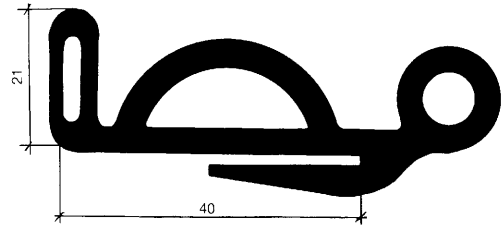

P 1414 gr./mt. 700 60 Sh

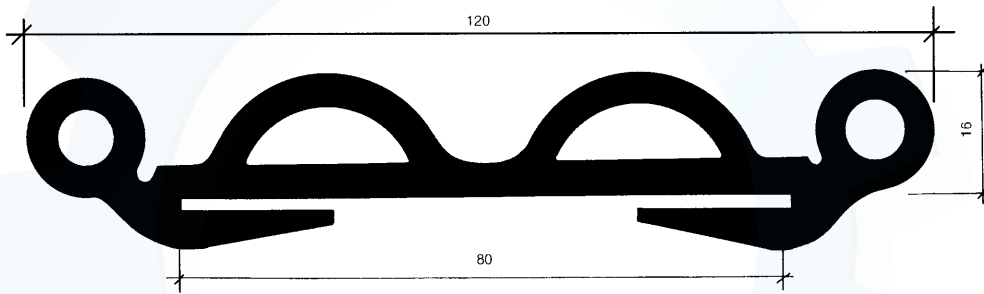

P 1415 gr./mt. 1280 60 Sh

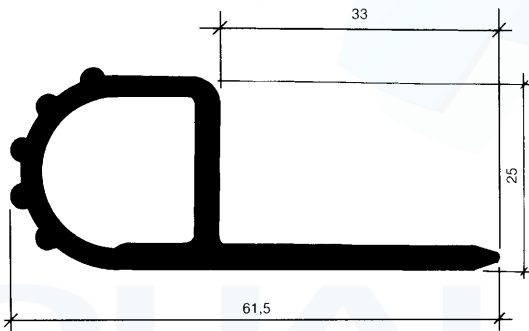

P 1416 gr./mt. 385 60 Sh

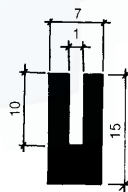

P 1417 gr./mt. 121 60 Sh

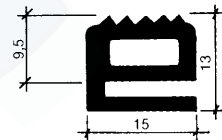

P 1418 gr./mt. 131 60 Sh

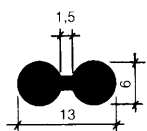

P 1419 gr./mt. 74 70 Sh

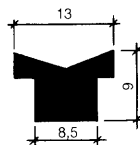

P 1420 gr./mt. 98 50 Sh

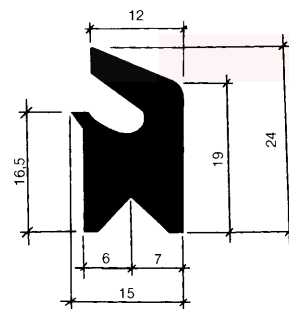

P 1421 gr./mt. 295 60 Sh

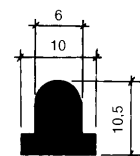

P 1422 gr./mt. 91 65 Sh

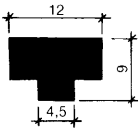

P 1423 gr./mt. 101 70 Sh

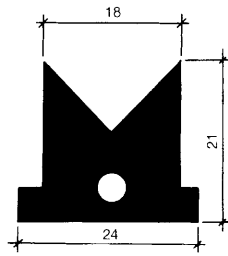

P 1424 gr./mt. 317 60 Sh

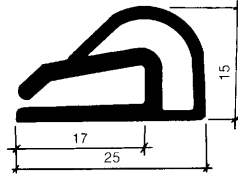

P 1425 gr./mt. 147 60 Sh



P 1426 gr./mt. 40 60 Sh

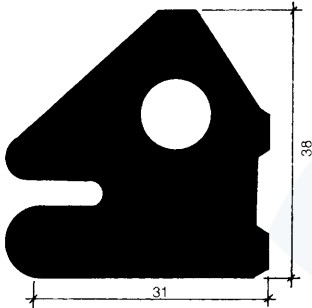

P 1427 gr./mt. 1175 60 Sh

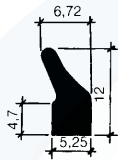

P 1428 gr./mt. 58 60 Sh

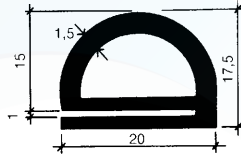

P 1429 gr./mt. 137 60 Sh

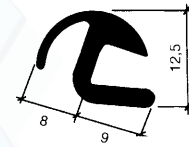

P 1430 gr./mt. 136 50 Sh

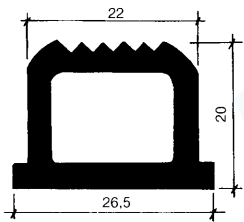

P 1431 gr./mt. 266 65 Sh

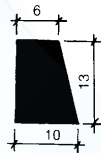

P 1432 gr./mt. 135 60 Sh



P 1433 gr./mt. 16 60 Sh

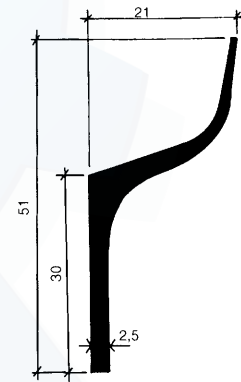

P 1434 gr./mt. 185 70 Sh

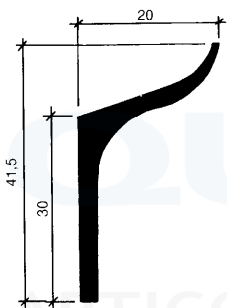

P 1435 gr./mt. 150 70 Sh

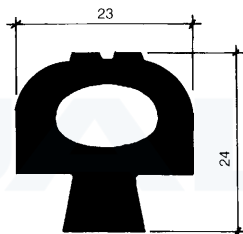

P 1436 gr./mt. 337 60 Sh

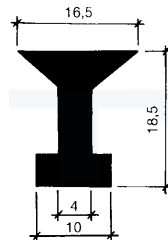

P 1437 gr./mt. 170 70 Sh

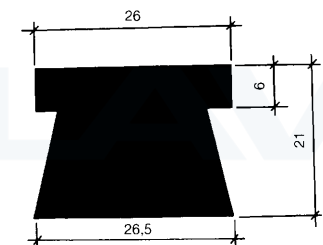

P 1438 gr./mt. 589 60 Sh

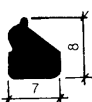

P 1439 gr./mt. 58 70 Sh

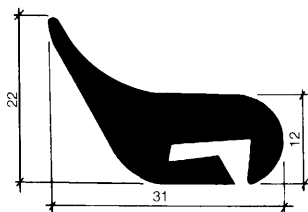

P 1440 gr./mt. 300 50 Sh

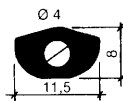

P 1441 gr./mt. 77 50 Sh

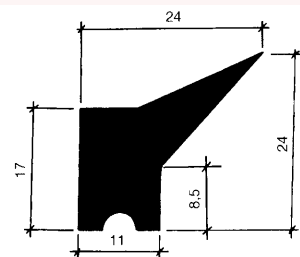

P 1442 gr./mt. 315 70 Sh

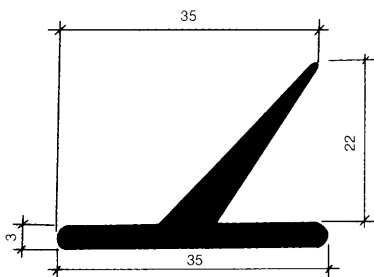

P 1443 gr./mt. 213 60 Sh

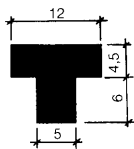

P 1444 gr./mt. 97 60 Sh

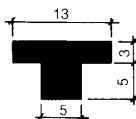

P 1445 gr./mt. 75 60 Sh

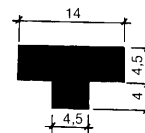

P 1446 gr./mt. 96 60 Sh

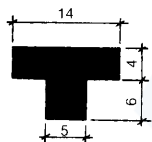

P 1447 gr./mt. 98 60 Sh

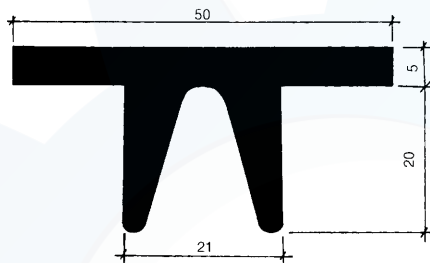

P 1448 gr./mt. 569 60 Sh

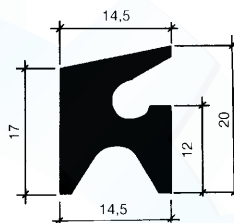

P 1449 gr./mt. 211 45 Sh

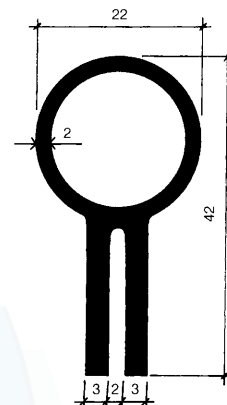

P 1450 gr./mt. 318 60 Sh

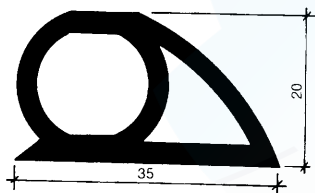

P 1451 gr./mt. 306 60 Sh

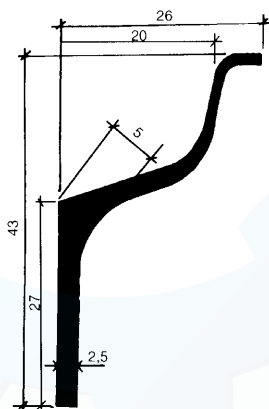

P 1452 gr./mt. 165 60 Sh

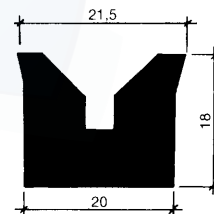

P 1453 gr./mt. 391 70 Sh

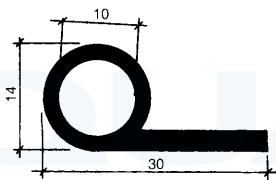

P 1454 gr./mt. 150 60 Sh

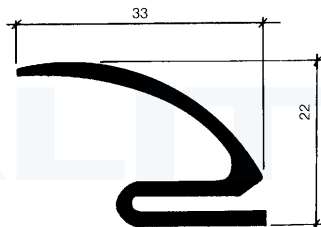

P 1455 gr./mt. 200 60 Sh

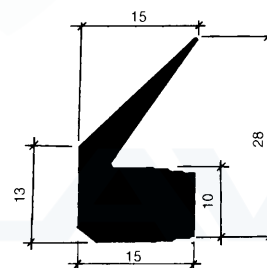

P 1456 gr./mt. 249 65 Sh

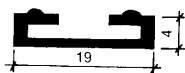

P 1457 gr./mt. 56 60 Sh

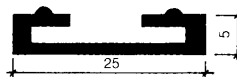

P 1458 gr./mt. 98 60 Sh

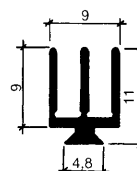

P 1459 gr./mt. 50 60 Sh

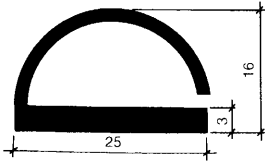

P 1460 gr./mt. 200 60 Sh

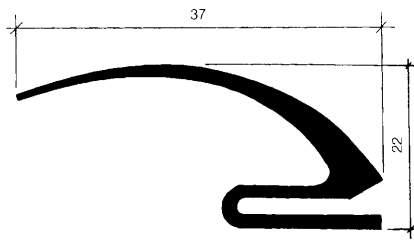

P 1461 gr./mt. 247 60 Sh

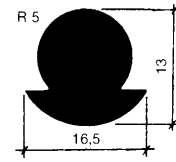

P 1462 gr./mt. 157 70 Sh

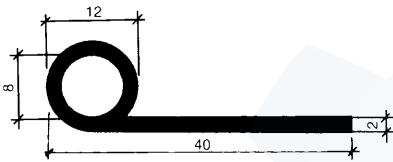

P 1463 gr./mt. 153 60 Sh



P 1464 gr./mt. 183 75 Sh

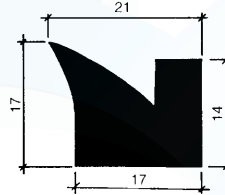

P 1465 gr./mt. 261 60 Sh

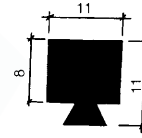

P 1466 gr./mt. 119 60 Sh

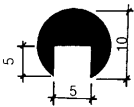

P 1467 gr./mt. 67 50 Sh

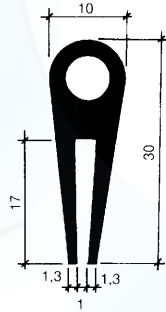

P 1468 gr./mt. 182 60 Sh

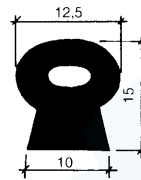

P 1469 gr./mt. 160 60 Sh

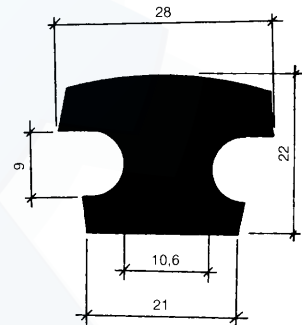

P 1470 gr./mt. 526 70 Sh

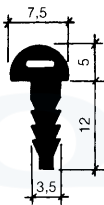

P 1471 gr./mt. 73 75 Sh

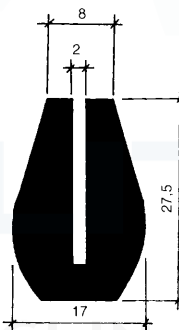

P 1472 gr./mt. 432 60 Sh

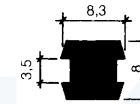

P 1473 gr./mt. 63 60 Sh

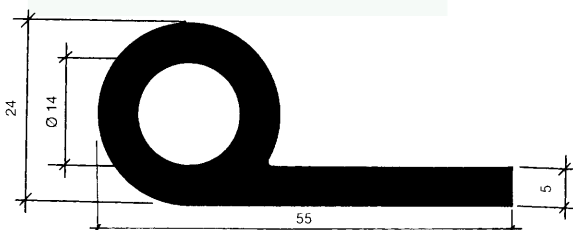

P 1474 gr./mt. 560 70 Sh



P 1475 gr./mt. 167 60 Sh

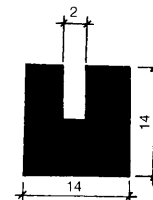

P 1476 gr./mt. 207 40 Sh

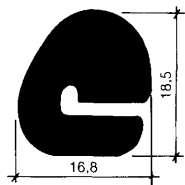

P 1477 gr./mt. 295 60 Sh

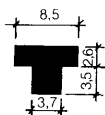

P 1478 gr./mt. 41 75 Sh

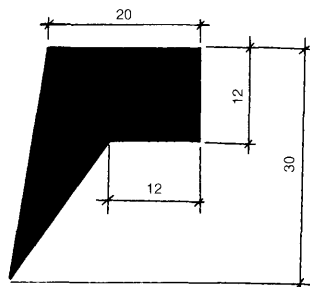

P 1479 gr./mt. 436 60 Sh

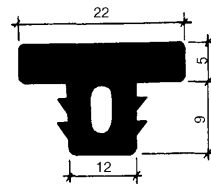

P 1480 gr./mt. 216 60 Sh

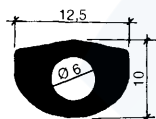

P 1481 gr./mt. 89 50 Sh

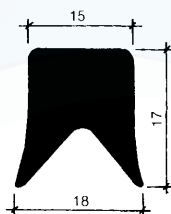

P 1482 gr./mt. 226 70 Sh

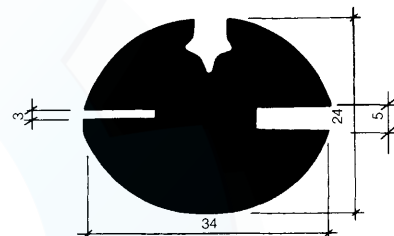

P 1483 gr./mt. 510 70 Sh

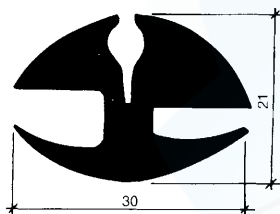

P 1484 gr./mt. 510 60 Sh

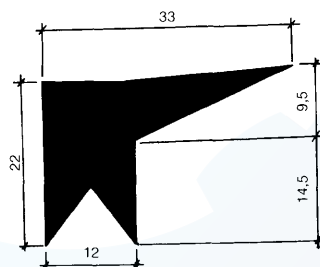

P 1485 gr./mt. 375 70 Sh



P 1486 gr./mt. 90 60 Sh

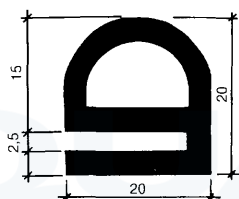

P 1487 gr./mt. 250 60 Sh

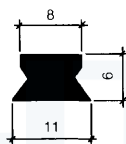

P 1488 gr./mt. 57 40 Sh

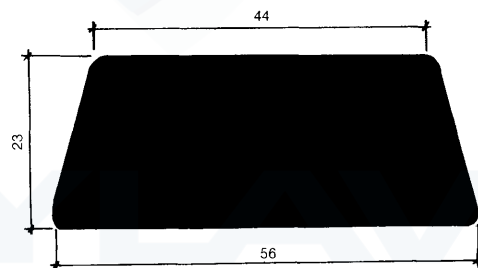

P 1489 gr./mt. 1500 70 Sh

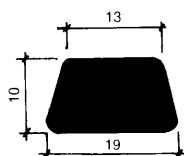

P 1490 gr./mt. 200 70 Sh

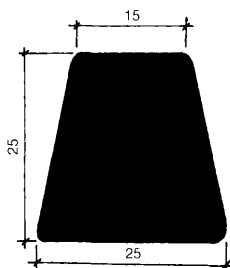

P 1491 gr./mt. 650 70 Sh

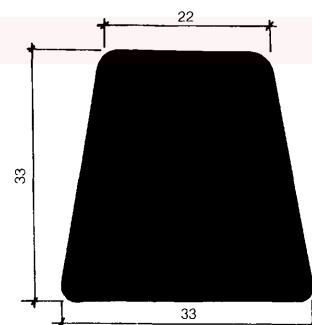

P 1492 gr./mt. 1180 70 Sh

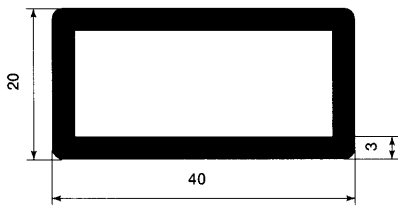

P 1493 gr./mt. 420 60 Sh

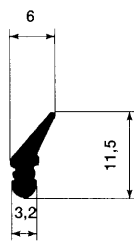

P 1494 gr./mt. 40 70 Sh

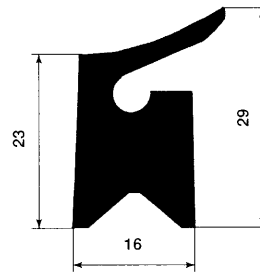

P 1495 gr./mt. 380 65 Sh

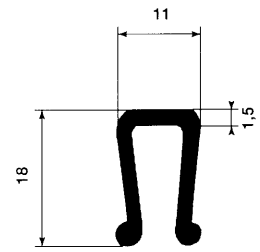

P 1496 gr./mt. 95 60 Sh

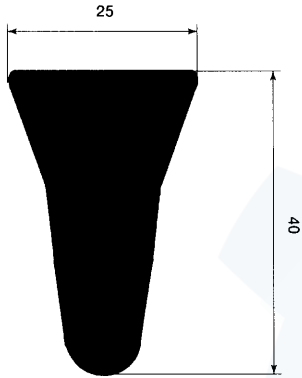

P 1497 gr./mt. 880 60 Sh

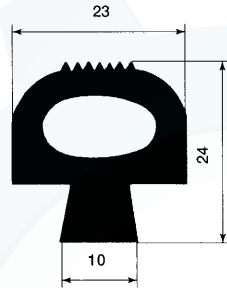

P 1498 gr./mt. 337 60 Sh

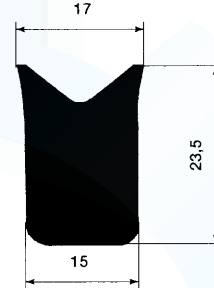

P 1499 gr./mt. 415 50 Sh

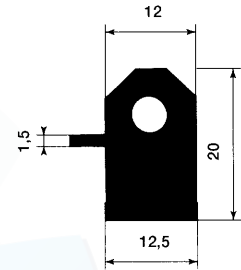

P 1500 gr./mt. 270 60 Sh

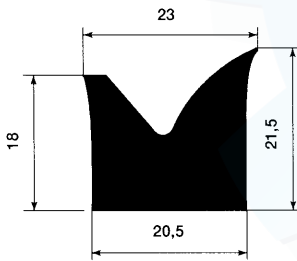

P 1501 gr./mt. 434 70 Sh



P 1502 gr./mt. 17 70 Sh

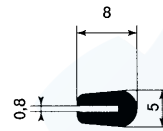

P 1503 gr./mt. 36 60 Sh

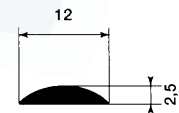

P 1504 gr./mt. 27 60 Sh

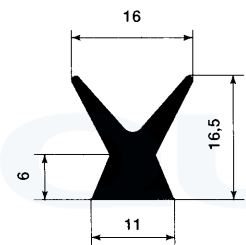

P 1505 gr./mt. 135 60 Sh

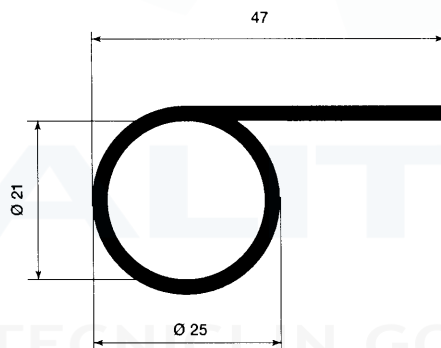

P 1506 gr./mt. 248 60 Sh

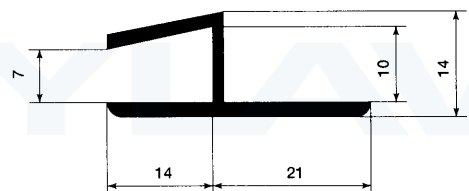

P 1507 gr./mt. 140 60 Sh

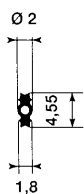

P 1508 gr./mt. 6.5 60 Sh

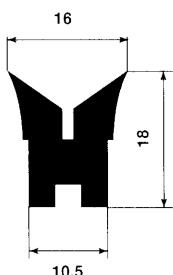

P 1509 gr./mt. 194 50 Sh

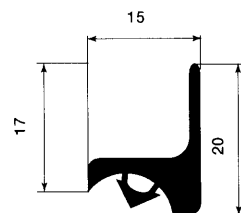

P 1510 gr./mt. 125 70 Sh

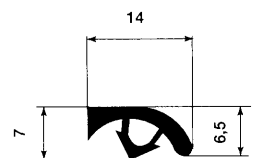

P 1511 gr./mt. 60 70 Sh

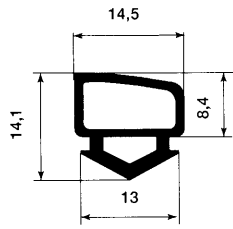

P 1512 gr./mt. 90 70 Sh

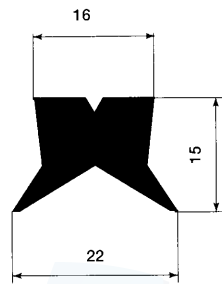

P 1513 gr./mt. 220 50 Sh

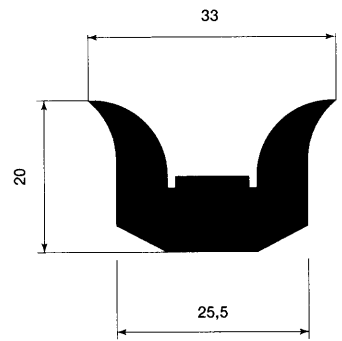

P 1514 gr./mt. 400 60 Sh

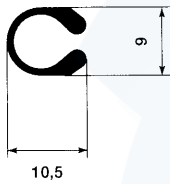

P 1515 gr./mt. 42 60 Sh

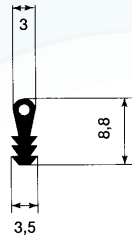

P 1516 gr./mt. 22 40 Sh

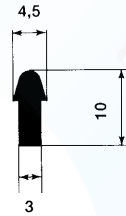

P 1517 gr./mt. 40 60 Sh

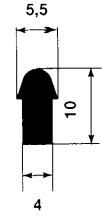

P 1518 gr./mt. 51 60 Sh

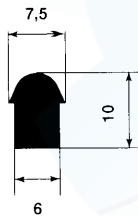

P 1519 gr./mt. 73 60 Sh

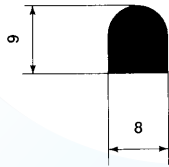

P 1520 gr./mt. 79 50 Sh

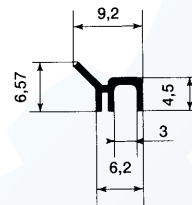

P 1521 gr./mt. 23 60 Sh

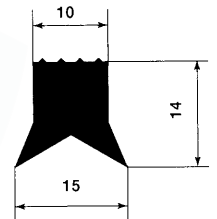

P 1522 gr./mt. 135 45 Sh

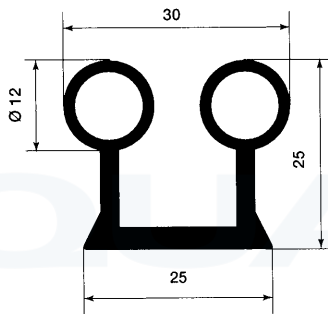

P 1523 gr./mt. 300 60 Sh

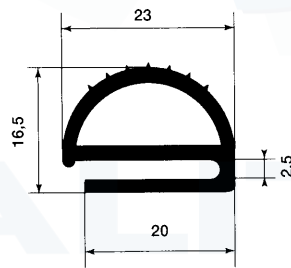

P 1524 gr./mt. 175 60 Sh

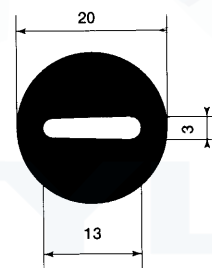

P 1525 gr./mt. 354 60 Sh

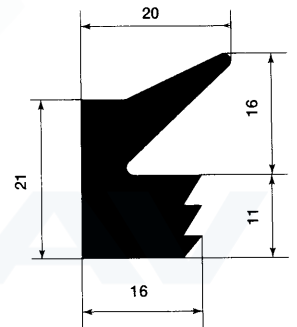

P 1526 gr./mt. 359 50 Sh

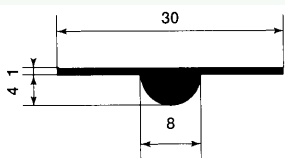

P 1527 gr./mt. 61 60 Sh

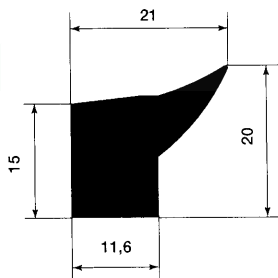

P 1528 gr./mt. 278 60 Sh

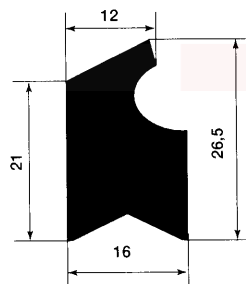

P 1529 gr./mt. 372 60 Sh

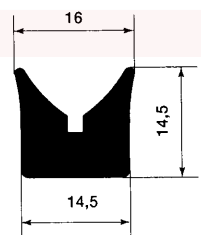

P 1530 gr./mt. 208 60 Sh

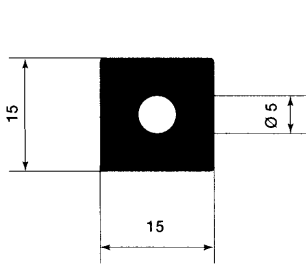

P 1531 gr./mt. 256 50 Sh

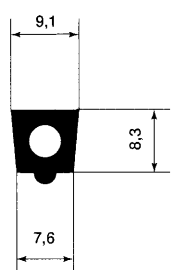

P 1532 gr./mt. 75 50 Sh

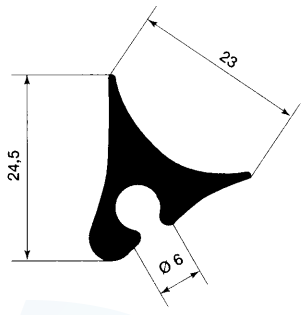

P 1533 gr./mt. 203 60 Sh

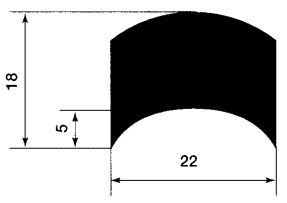

P 1534 gr./mt. 374 60 Sh

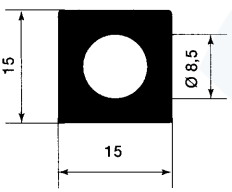

P 1535 gr./mt. 204 55 Sh



P 1536 gr./mt. 253 60 Sh

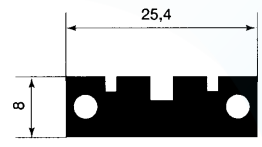

P 1537 gr./mt. 207 60 Sh

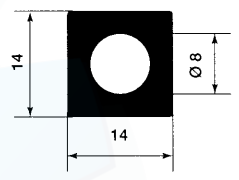

P 1538 gr./mt. 180 60 Sh

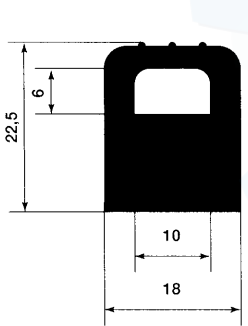

P 1539 gr./mt. 420 60 Sh

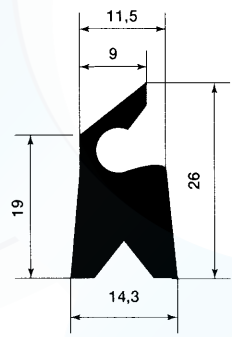

P 1540 gr./mt. 252 70 Sh

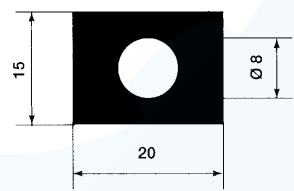

P 1541 gr./mt. 322 50 Sh

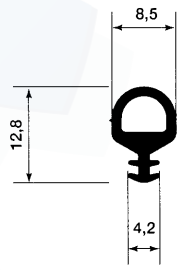

P 1542 gr./mt. 56 50 Sh

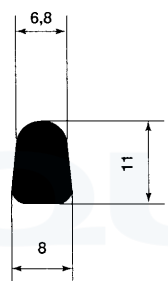

P 1543 gr./mt. 97 70 Sh

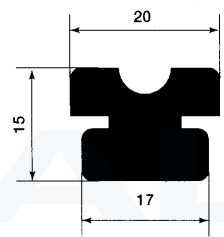

P 1544 gr./mt. 290 60 Sh

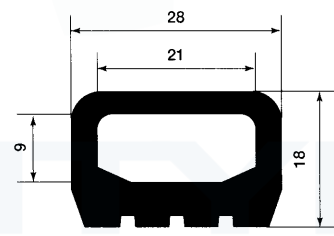

P 1545 gr./mt. 313 45 Sh

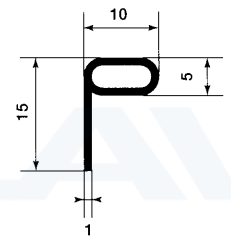

P 1546 gr./mt. 39 60 Sh

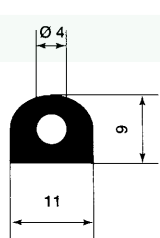

P 1547 gr./mt. 98 60 Sh

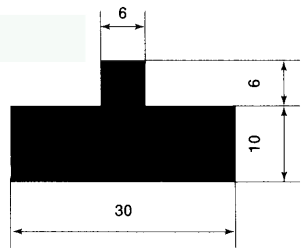

P 1548 gr./mt. 379 60 Sh

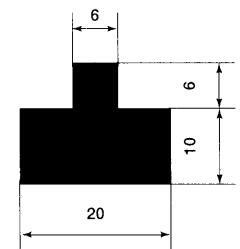

P 1549 gr./mt. 277 60 Sh

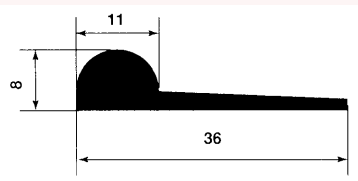

P 1550 gr./mt. 160 45 Sh

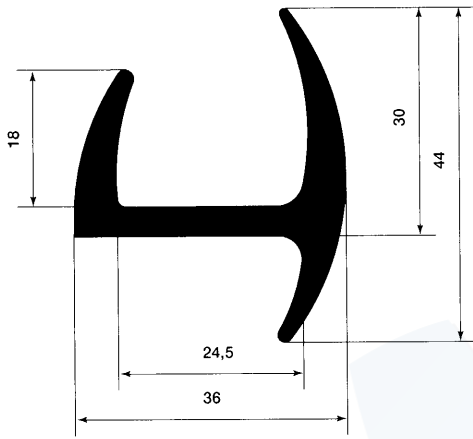

P 1551 gr./mt. 534 60 Sh

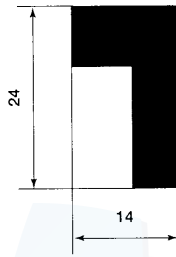

P 1552 gr./mt. 257 50 Sh

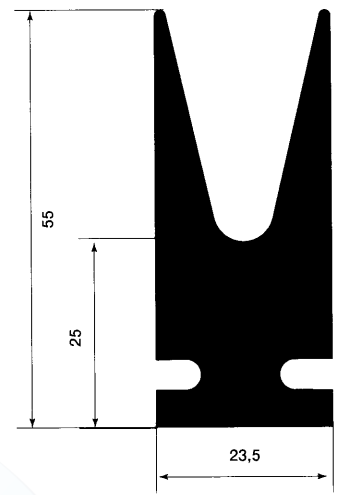

P 1553 gr./mt. 944 50 Sh

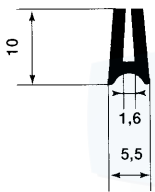

P 1554 gr./mt. 44 60 Sh

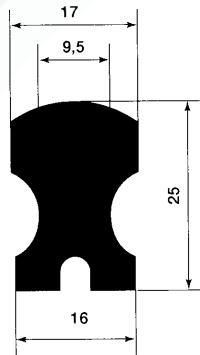

P 1555 gr./mt. 414 70 Sh

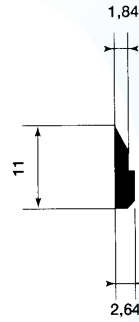

P 1556 gr./mt. 25 60 Sh

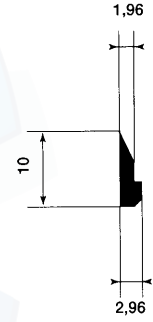

P 1557 gr./mt. 25 60 Sh

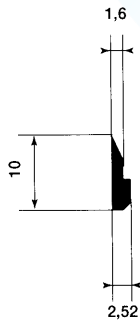

P 1558 gr./mt. 21 60 Sh

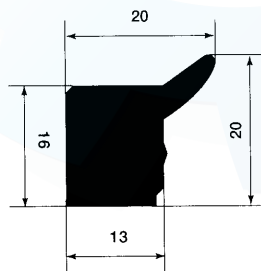

P 1559 gr./mt. 301 70 Sh

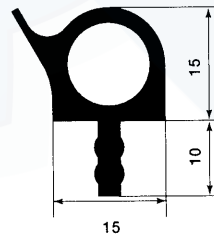

P 1560 gr./mt. 197 60 Sh

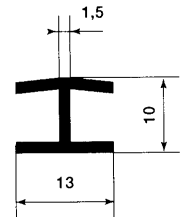

P 1561 gr./mt. 65 70 Sh

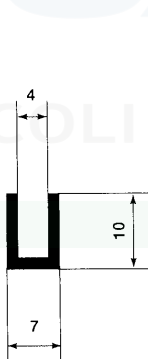

P 1562 gr./mt. 41 60 Sh

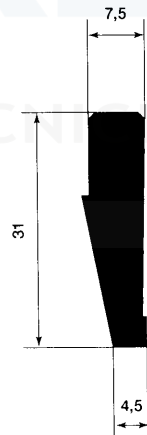

P 1563 gr./mt. 220 45 Sh

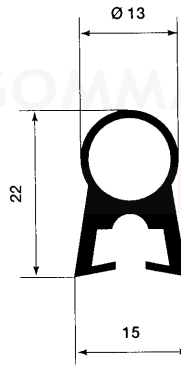

P 1564 gr./mt. 165 70 Sh

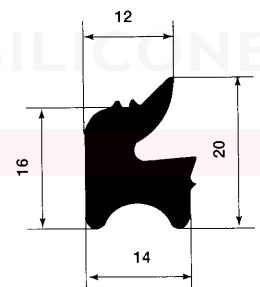

P 1565 gr./mt. 200 50 Sh

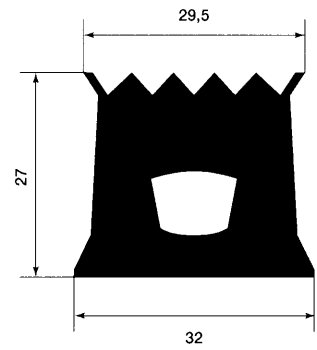
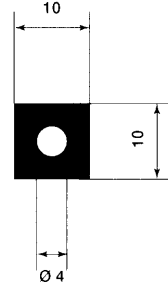
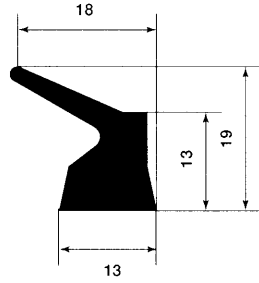
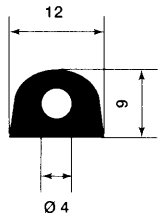

P 1566 gr./mt. 102 60 Sh

P 1567 gr./mt. 183 60 Sh

P 1568 gr./mt. 112 60 Sh

P 1569 gr./mt. 760 70 Sh

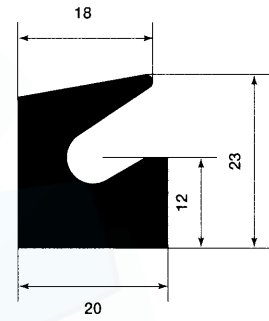
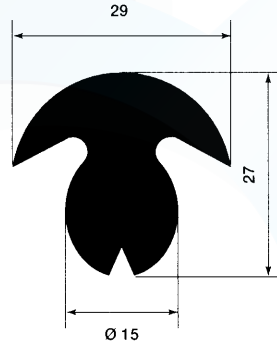
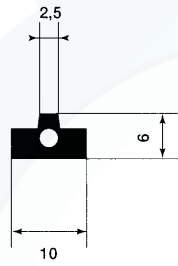
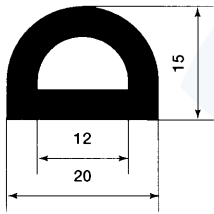

P 1570 gr./mt. 225 60 Sh

P 1571 gr./mt. 50 50 Sh

P 1572 gr./mt. 536 60 Sh

P 1573 gr./mt. 424 60 Sh

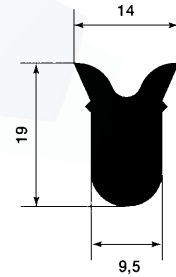
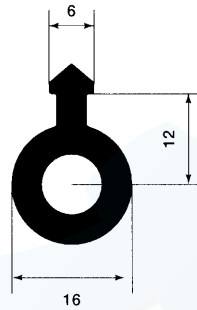
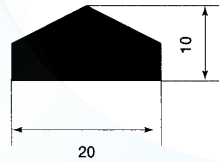
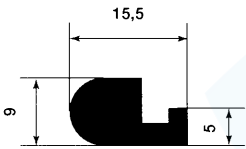

P 1574 gr./mt. 128 70 Sh

P 1575 gr./mt. 187 60 Sh

P 1576 gr./mt. 222 60 Sh

P 1577 gr./mt. 192 60 Sh

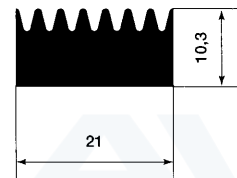
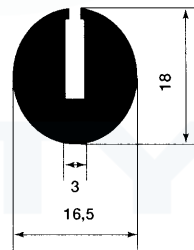
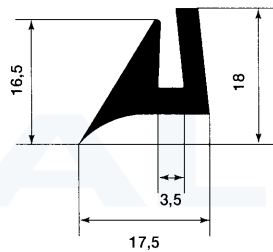
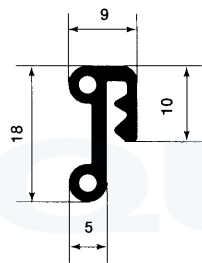

P 1578 gr./mt. 104 60 Sh

P 1579 gr./mt. 155 60 Sh

P 1580 gr./mt. 245 60 Sh

P 1581 gr./mt. 250 60 Sh

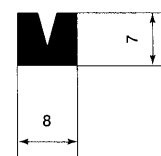
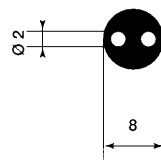
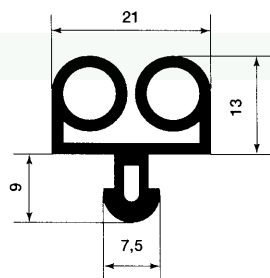

P 1582 gr./mt. 210 60 Sh

P 1583 gr./mt. 57 60 Sh

P 1584 gr./mt. 65 60 Sh

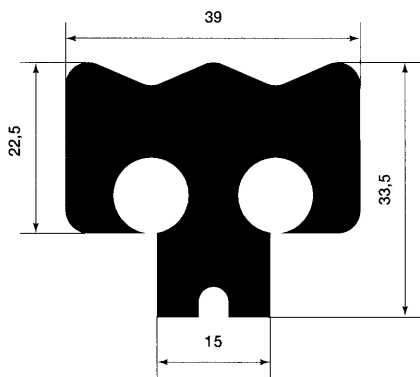

P 1585 gr./mt. 1080 60 Sh

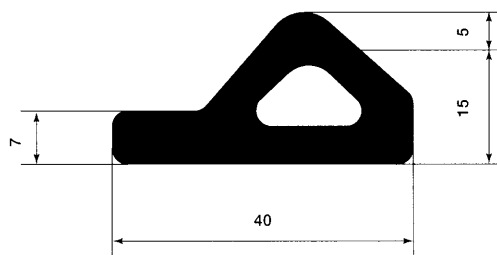

P 1586 gr./mt. 550 60 Sh

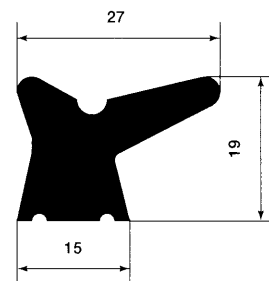

P 1587 gr./mt. 341 70 Sh

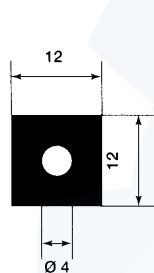

P 1588 gr./mt. 167 60 Sh

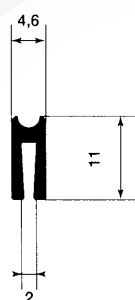

P 1589 gr./mt. 46 60 Sh

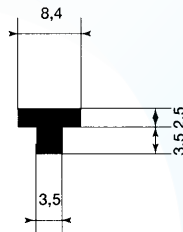

P 1590 gr./mt. 38 50 Sh

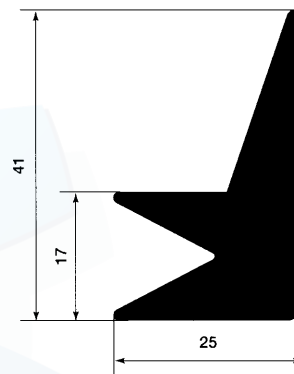

P 1591 gr./mt. 592 60 Sh

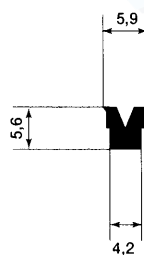

P 1592 gr./mt. 29 80 Sh

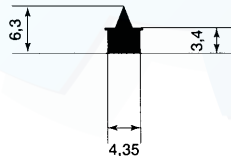

P 1593 gr./mt. 22 80 Sh

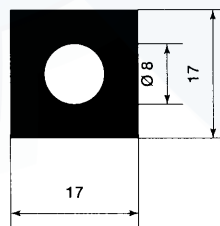

P 1594 gr./mt. 296 60 Sh

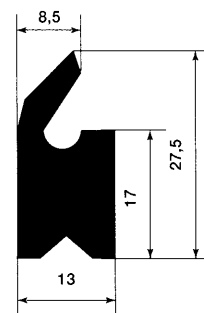

P 1595 gr./mt. 270 55 Sh

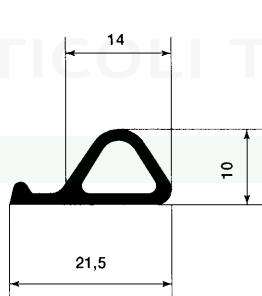

P 1596 gr./mt. 100 60 Sh

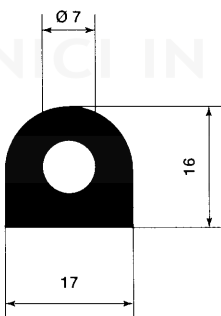

P 1597 gr./mt. 243 60 Sh

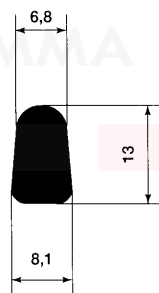

P 1598 gr./mt. 111 70 Sh

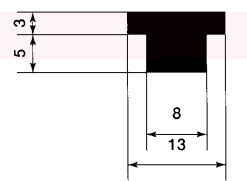

P 1599 gr./mt. 91 40 Sh

QUALITY LAW

ARTICOLI TECNICI IN GOMMA E SILICONE

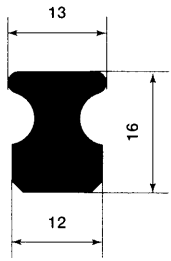

P 1600 gr./mt. 224 70 Sh

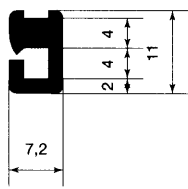

P 1601 gr./mt. 78 70 Sh

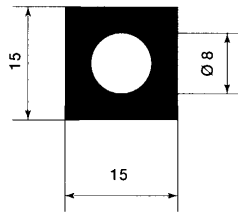

P 1602 gr./mt. 221 63 Sh

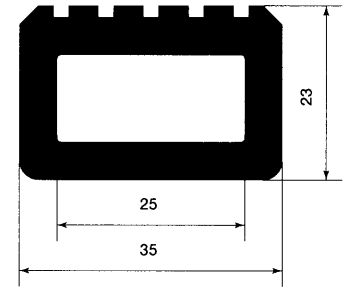

P 1603 gr./mt. 610 60 Sh

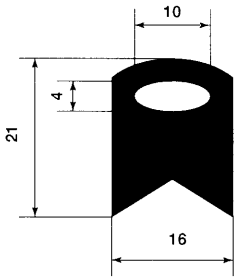

P 1604 gr./mt. 326 60 Sh

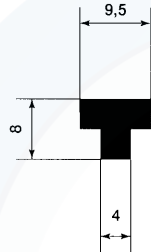

P 1605 gr./mt. 68 70 Sh

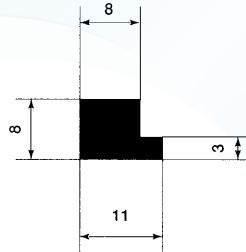

P 1606 gr./mt. 92 60 Sh

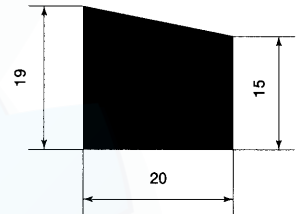

P 1607 gr./mt. 400 50 Sh

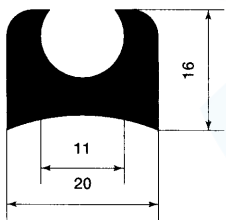

P 1608 gr./mt. 276 60 Sh

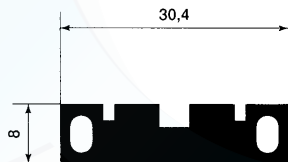

P 1609 gr./mt. 230 50 Sh



P 1610 gr./mt. 46 60 Sh

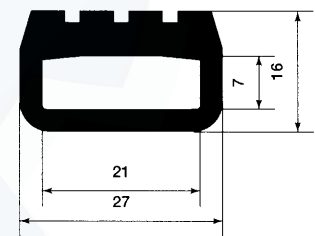

P 1611 gr./mt. 308 45 Sh

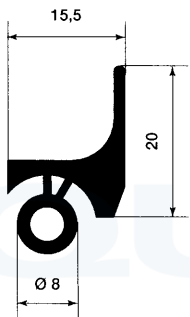

P 1612 gr./mt. 180 70 Sh

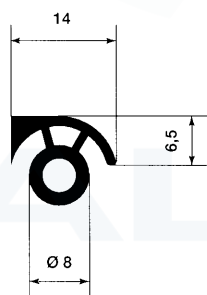

P 1613 gr./mt. 105 70 Sh

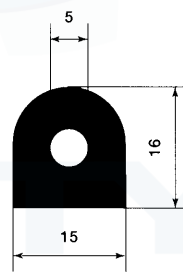

P 1614 gr./mt. 234 60 Sh

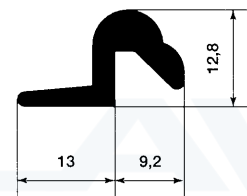

P 1615 gr./mt. 130 70 Sh

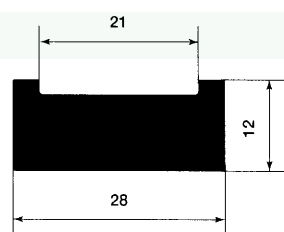

P 1616 gr./mt. 328 30 Sh

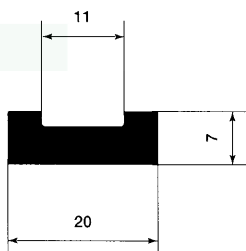

P 1617 gr./mt. 150 60 Sh

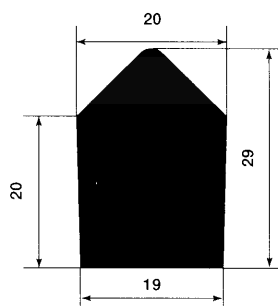

P 1618 gr./mt. 600 60 Sh

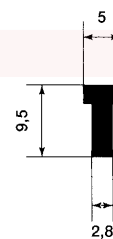

P 1619 gr./mt. 37 60 Sh

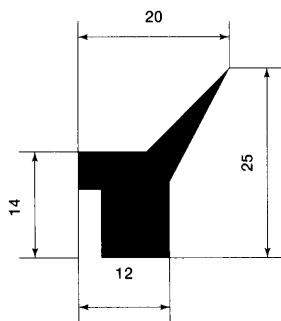

P 1620 gr./mt. 228 60 Sh

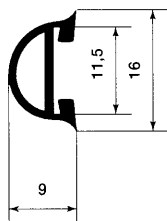

P 1621 gr./mt. 76 60 Sh

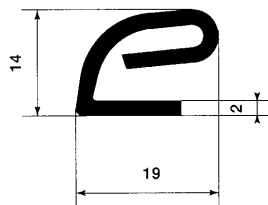

P 1622 gr./mt. 140 60 Sh

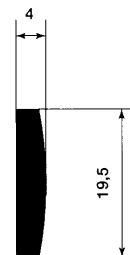

P 1623 gr./mt. 84 70 Sh



P 1624 gr./mt. 12 50 Sh

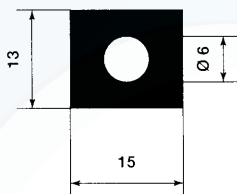

P 1625 gr./mt. 205 60 Sh

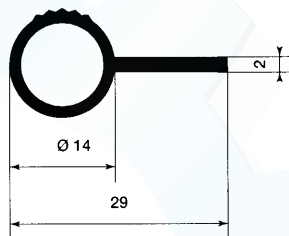

P 1626 gr./mt. 129 55 Sh

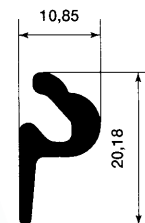

P 1627 gr./mt. 88 75 Sh

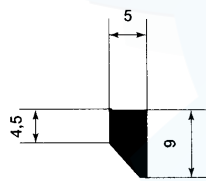

P 1628 gr./mt. 45 60 Sh

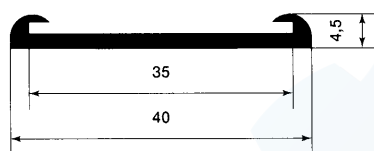

P 1629 gr./mt. 124 60 Sh

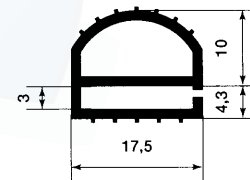

P 1630 gr./mt. 94 60 Sh

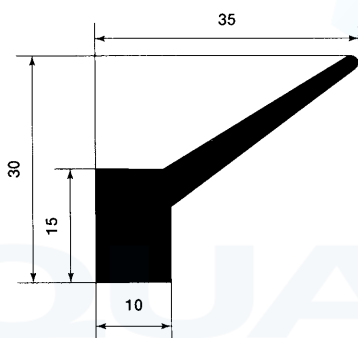

P 1631 gr./mt. 315 60 Sh

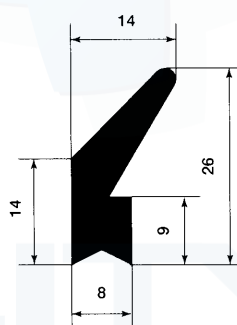

P 1632 gr./mt. 215 60 Sh

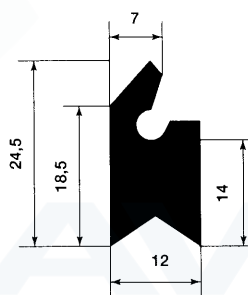

P 1633 gr./mt. 254 60 Sh

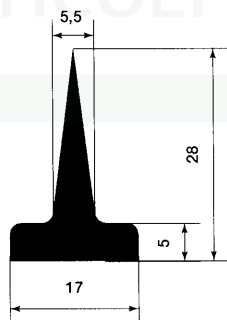

P 1634 gr./mt. 209 70 Sh

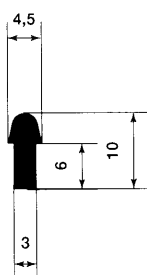

P 1635 gr./mt. 44 78 Sh

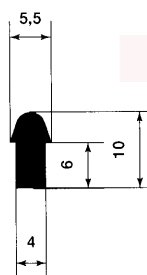

P 1636 gr./mt. 54 78 Sh

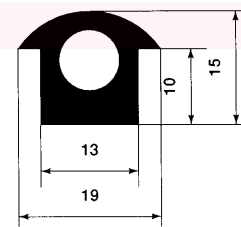

P 1637 gr./mt. 189 60 Sh

ARTICOLI TECNICI IN GOMMA E SILICONE

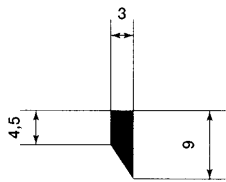

P 1638 gr./mt. 27 60 Sh

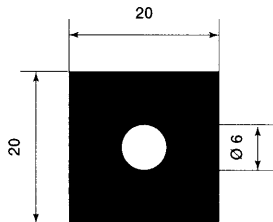

P 1639 gr./mt. 470 50 Sh

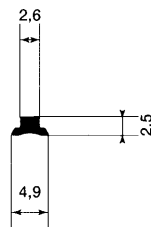

P 1640 gr./mt. 9 50 Sh

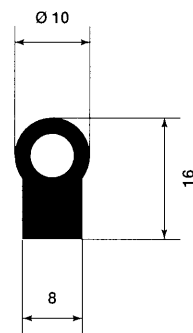

P 1641 gr./mt. 140 40 Sh

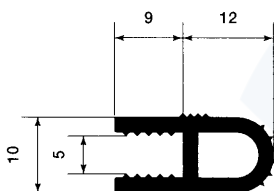

P 1642 gr./mt. 158 70 Sh

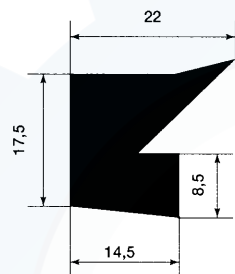

P 1643 gr./mt. 307 60 Sh



P 1644 gr./mt. 197 70 Sh

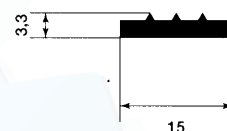

P 1645 gr./mt. 42 60 Sh

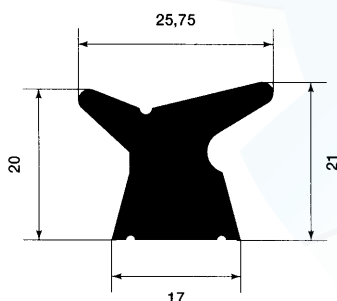

P 1646 gr./mt. 388 70 Sh

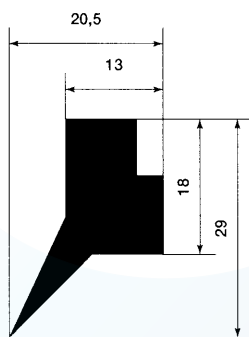

P 1647 gr./mt. 305 70 Sh

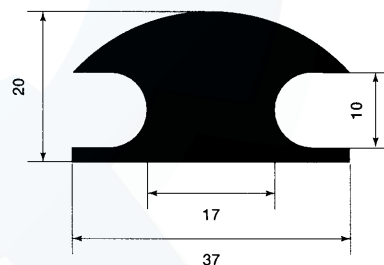

P 1648 gr./mt. 599 60 Sh

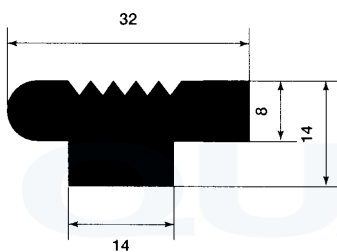

P 1649 gr./mt. 378 50 Sh

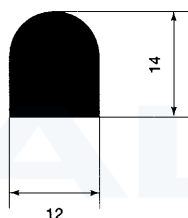

P 1650 gr./mt. 184 45 Sh

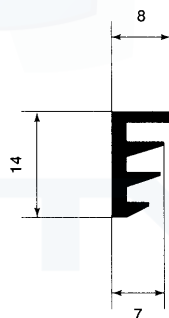

P 1651 gr./mt. 55 50 Sh

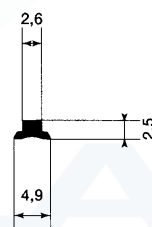

P 1652 gr./mt. 10 70 Sh

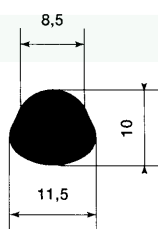

P 1653 gr./mt. 116 60 Sh

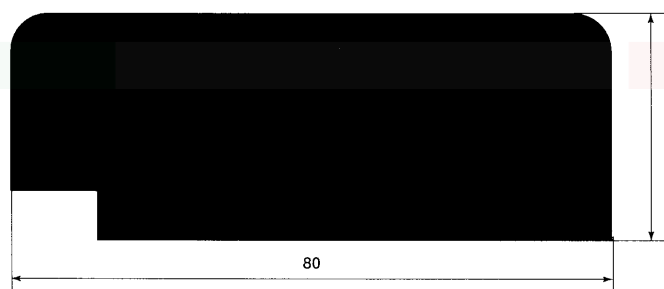

P 1654 gr./mt. 2900 65 Sh

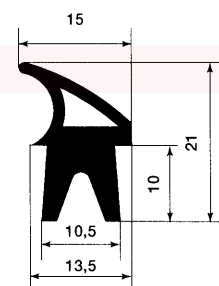

P 1655 gr./mt. 150 50 Sh

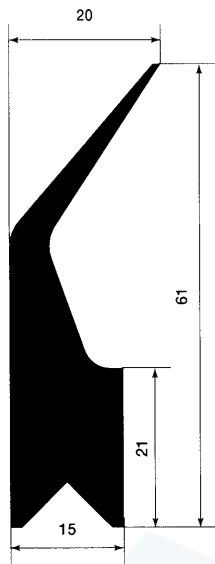

P 1656 gr./mt. 593 70 Sh

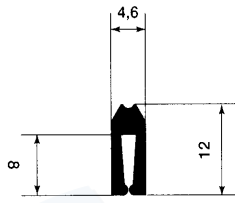

P 1657 gr./mt. 52 60 Sh

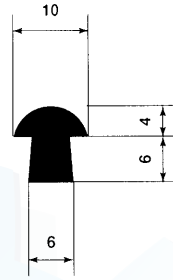

P 1658 gr./mt. 77 60 Sh

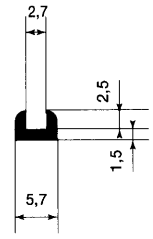

P 1659 gr./mt. 19 60 Sh

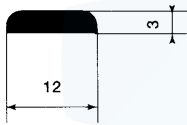

P 1660 gr./mt. 41 60 Sh

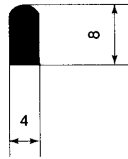

P 1661 gr./mt. 41 60 Sh

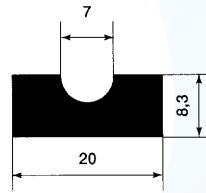

P 1662 gr./mt. 180 60 Sh

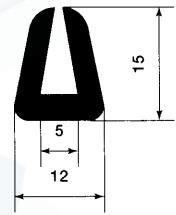

P 1663 gr./mt. 147 60 Sh

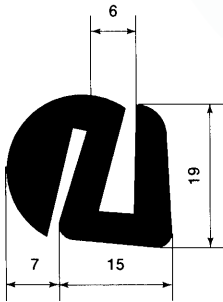

P 1664 gr./mt. 321 60 Sh

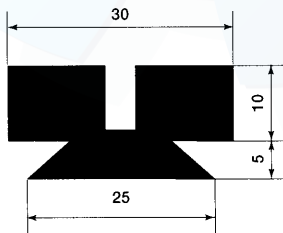

P 1665 gr./mt. 450 60 Sh

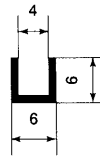

P 1666 gr./mt. 19 60 Sh

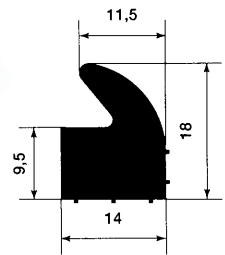

P 1667 gr./mt. 250 70 Sh

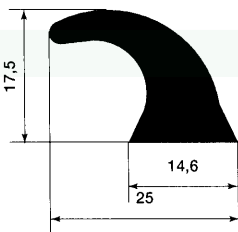

P 1668 gr./mt. 280 50 Sh

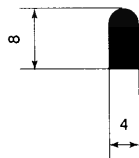

P 1669 gr./mt. 38 50 Sh

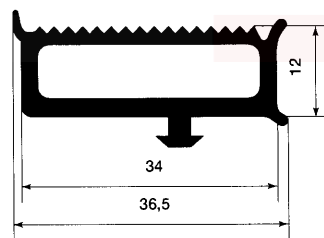

P 1670 gr./mt. 280 60 Sh

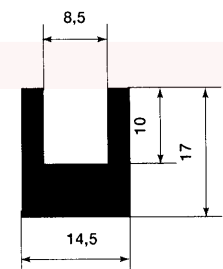

P 1671 gr./mt. 200 50 Sh

QUALITY LAY

ARTICOLI TECNICI IN GOMMA E SILICONE

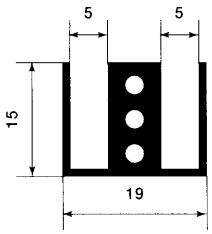

P 1672 gr./mt. 180 70 Sh

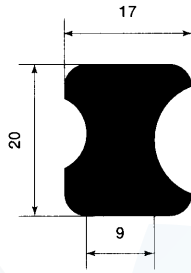

P 1673 gr./mt. 305 60 Sh

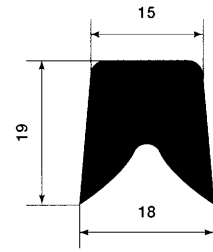

P 1674 gr./mt. 290 70 Sh

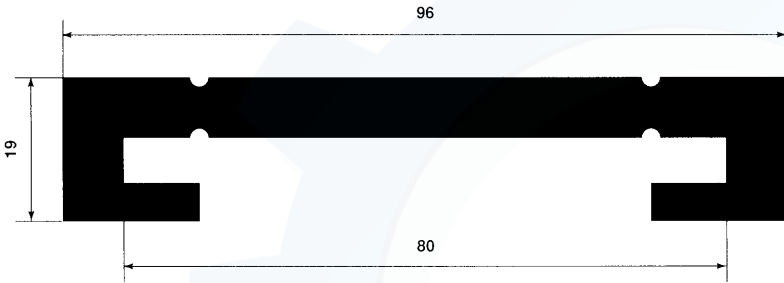

P 1675 gr./mt. 1160 75 Sh

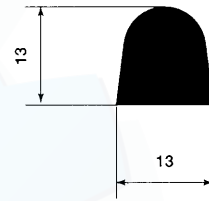

P 1676 gr./mt. 190 60 Sh

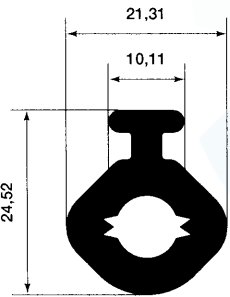

P 1677 gr./mt. 350 60 Sh



P 1678 gr./mt. 130 60 Sh

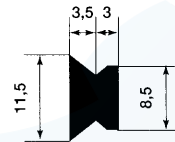

P 1679 gr./mt. 60 60 Sh



P 1680 gr./mt. 37 65 Sh

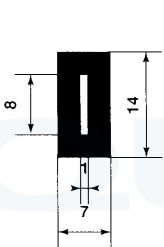

P 1681 gr./mt. 115 60 Sh

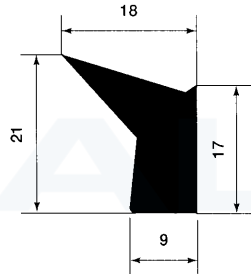

P 1682 gr./mt. 190 60 Sh

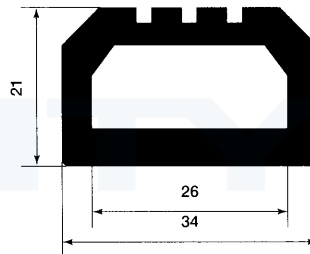

P 1683 gr./mt. 505 60 Sh

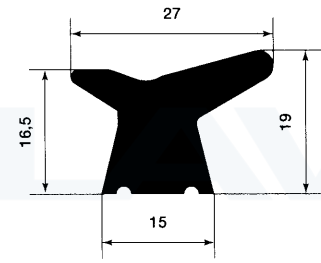

P 1684 gr./mt. 325 70 Sh

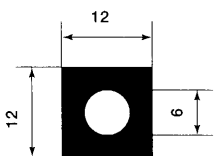

P 1685 gr./mt. 145 60 Sh

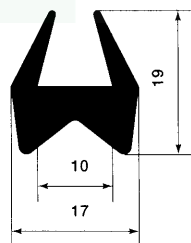

P 1686 gr./mt. 180 40 Sh

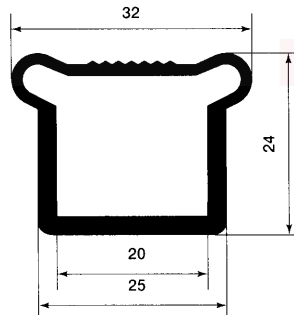

P 1687 gr./mt. 254 60 Sh

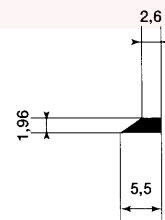

P 1688 gr./mt. 10 60 Sh

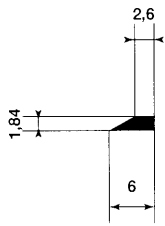

P 1689 gr./mt. 10 60 Sh

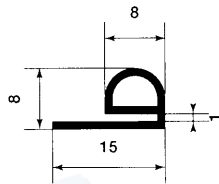

P 1690 gr./mt. 52 60 Sh

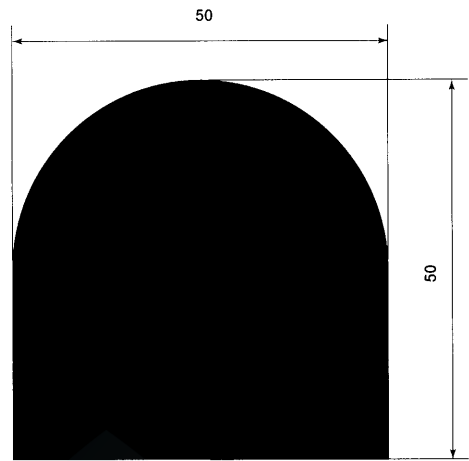

P 1691 gr./mt. 2900 60 Sh

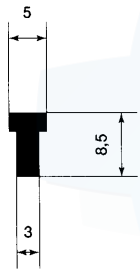

P 1692 gr./mt. 37 50 Sh

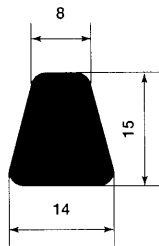

P 1693 gr./mt. 205 60 Sh

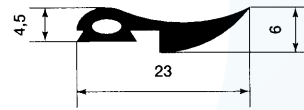

P 1694 gr./mt. 70 70 Sh

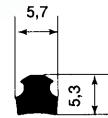

P 1695 gr./mt. 38 60 Sh

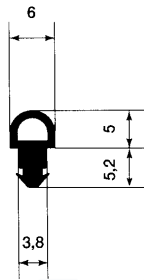

P 1696 gr./mt. 46 60 Sh

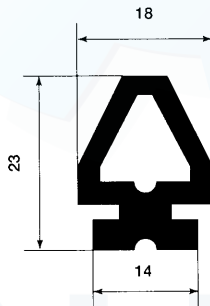

P 1697 gr./mt. 228 60 Sh

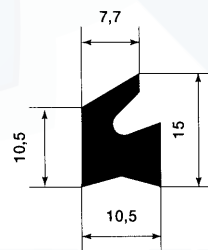

P 1698 gr./mt. 136 75 Sh

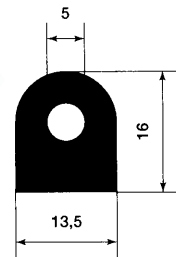

P 1699 gr./mt. 216 60 Sh

ARTICOLI TECNICI IN GOMMA E SILICONE

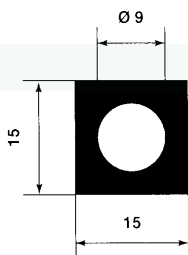

P 1670 gr./mt. 202 50 Sh

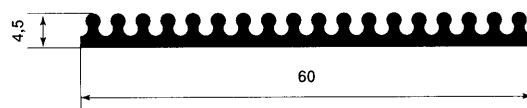

P 1701 gr./mt. 225 40 Sh

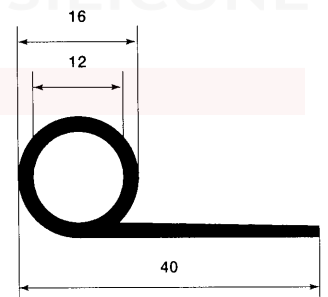

P 1702 gr./mt. 168 60 Sh

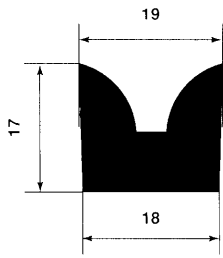

P 1703 gr./mt. 270 60 Sh

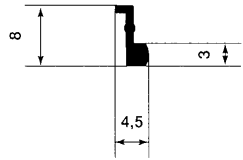

P 1704 gr./mt. 17 45 Sh

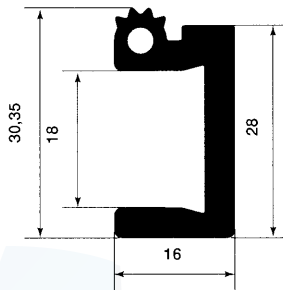

P 1705 gr./mt. 307 60 Sh

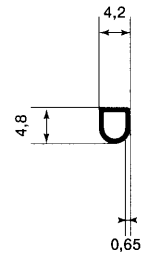

P 1706 gr./mt. 14 50 Sh

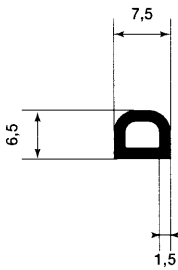

P 1707 gr./mt. 41 50 Sh

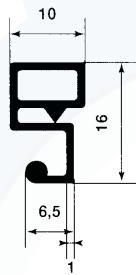

P 1708 gr./mt. 81 70 Sh

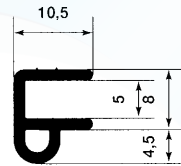

P 1709 gr./mt. 73 50 Sh

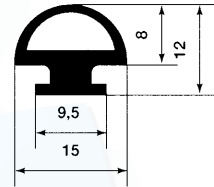

P 1710 gr./mt. 100 60 Sh

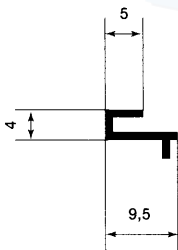

P 1711 gr./mt. 30 60 Sh

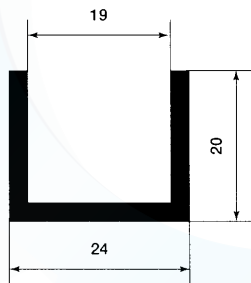

P 1712 gr./mt. 178 60 Sh

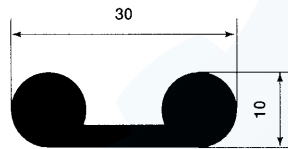

P 1713 gr./mt. 260 60 Sh

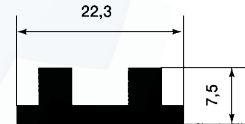

P 1714 gr./mt. 119 75 Sh

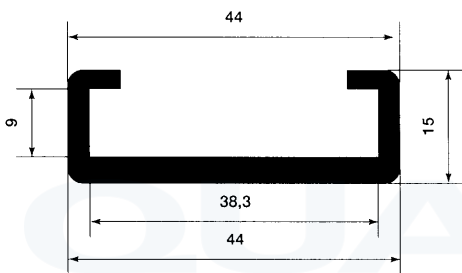

P 1715 gr./mt. 302 70 Sh

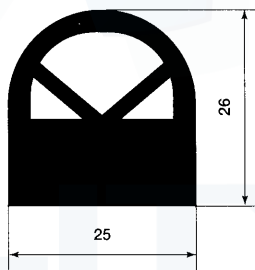

P 1716 gr./mt. 525 50 Sh

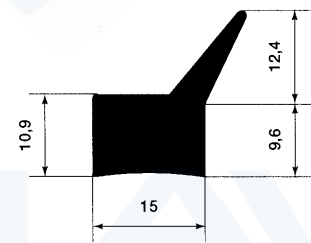

P 1717 gr./mt. 240 60 Sh

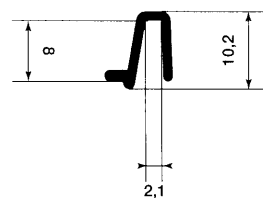

P 1718 gr./mt. 39 60 Sh

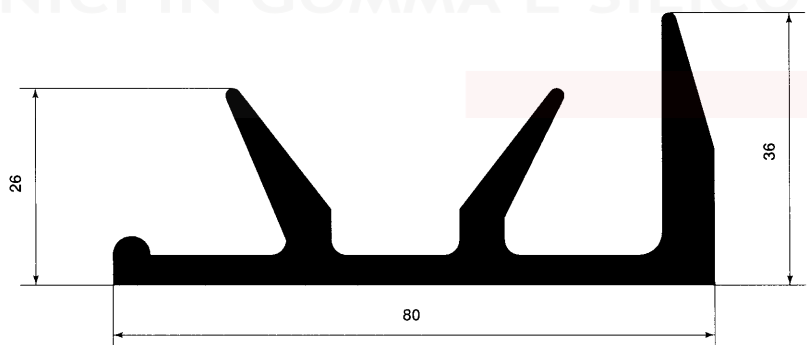

P 1719 gr./mt. 910 70 Sh

ARTICOLI TECNICI IN GOMMA E SILICONE

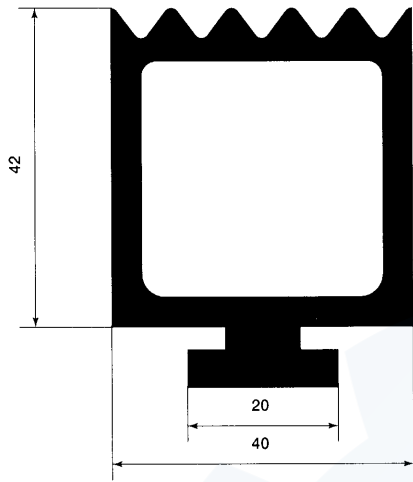

P 1720 gr./mt. 980 70 Sh

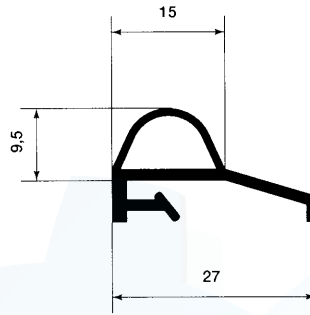

P 1721 gr./mt. 145 60 Sh

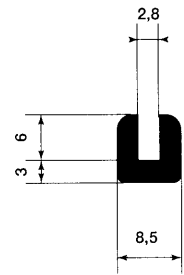

P 1722 gr./mt. 70 60 Sh

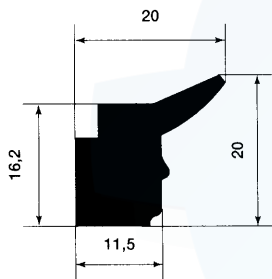

P 1723 gr./mt. 265 60 Sh

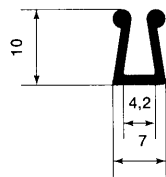

P 1724 gr./mt. 47 60 Sh

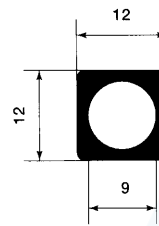

P 1725 gr./mt. 102 65 Sh

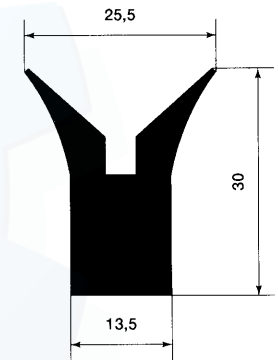

P 1726 gr./mt. 400 65 Sh

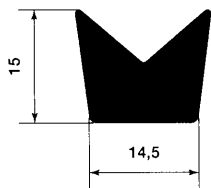

P 1727 gr./mt. 205 60 Sh

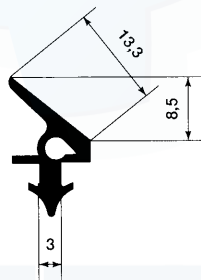

P 1728 gr./mt. 75 60 Sh

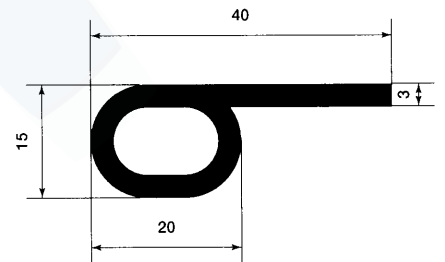

P 1729 gr./mt. 258 60 Sh

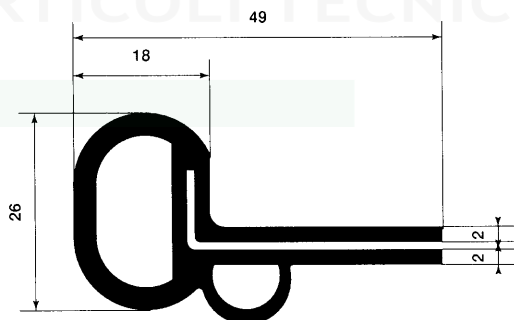

P 1730 gr./mt. 486 60 Sh

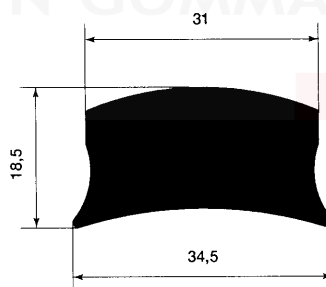

P 1731 gr./mt. 560 60 Sh

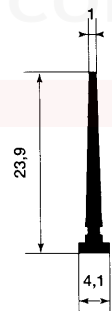

P 1732 gr./mt. 54 70 Sh

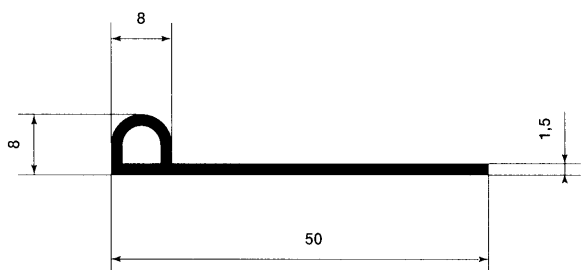

P 1733 gr./mt. 120 60 Sh

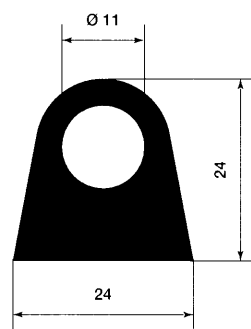

P 1734 gr./mt. 455 60 Sh

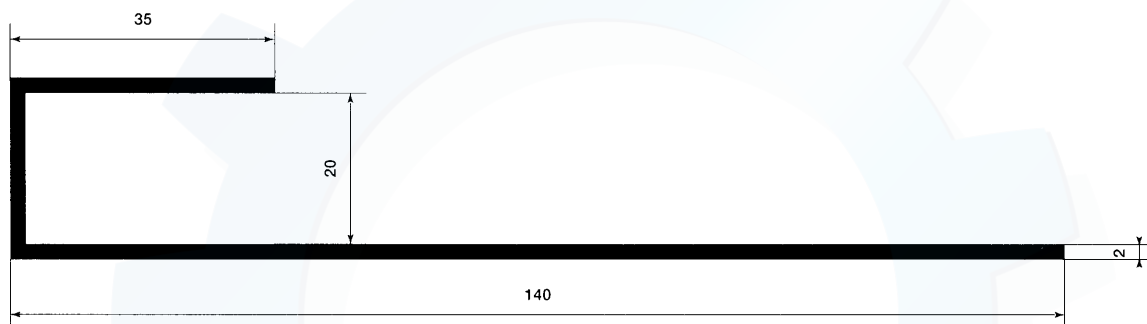

P 1735 gr./mt. 490 60 Sh

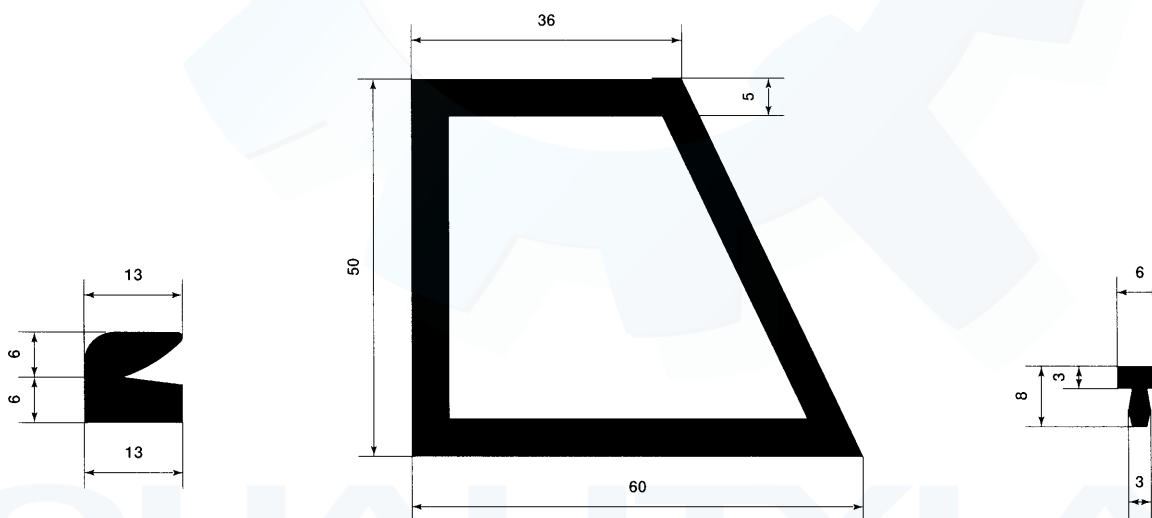

P 1736 gr./mt. 155 60 Sh

P 1737 gr./mt. 1220 60 Sh

P 1738 gr./mt. 37 50 Sh

QUALITYLAV
ARTICOLI TECNICI IN GOMMA E SILICONE

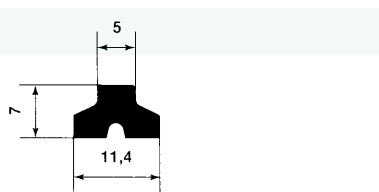

P 1739 gr./mt. 61 60 Sh

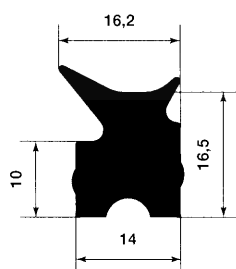

P 1740 gr./mt. 273 70 Sh

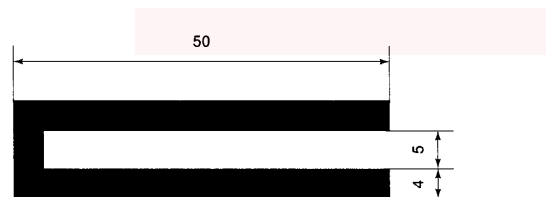

P 1741 gr./mt. 499 60 Sh

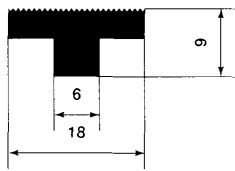

P 1742 gr./mt. 130 60 Sh

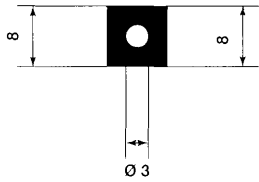

P 1743 gr./mt. 71 60 Sh

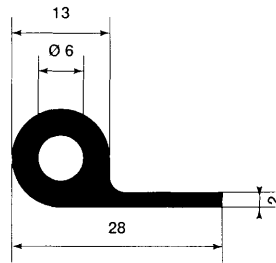

P 1744 gr./mt. 180 60 Sh

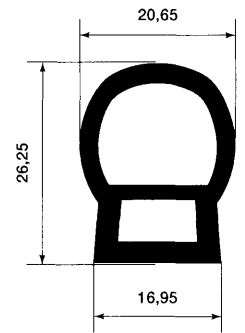

P 1745 gr./mt. 500 60 Sh

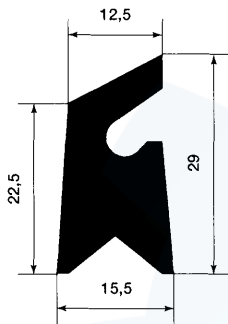

P 1746 gr./mt. 348 60 Sh

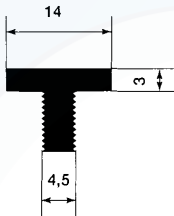

P 1747 gr./mt. 100 60 Sh

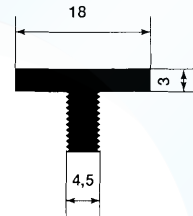

P 1748 gr./mt. 115 60 Sh

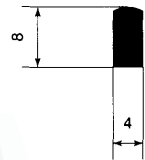

P 1749 gr./mt. 40 70 Sh

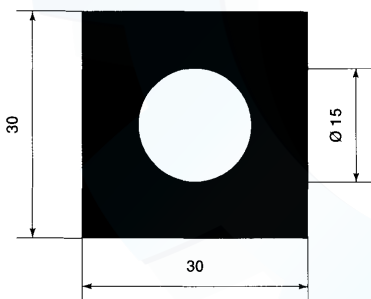

P 1750 gr./mt. 904 60 Sh

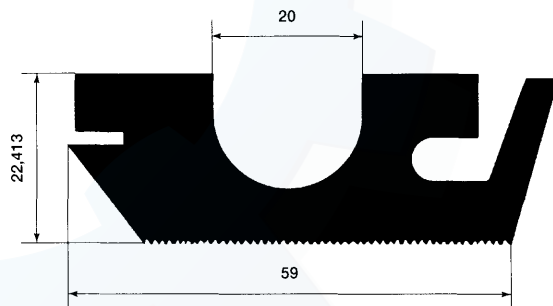

P 1751 gr./mt. 1300 50 Sh

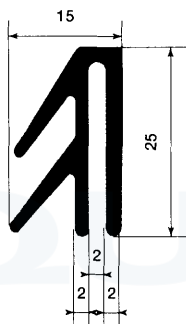

P 1752 gr./mt. 200 60 Sh

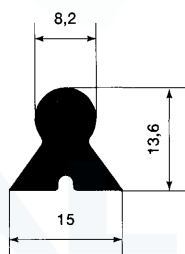

P 1753 gr./mt. 117 60 Sh

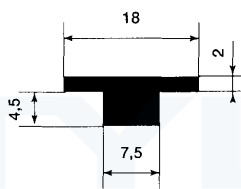

P 1754 gr./mt. 87 75 Sh

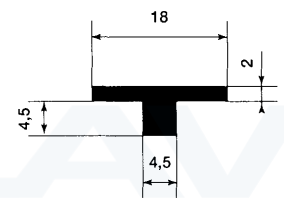

P 1755 gr./mt. 70 75 Sh

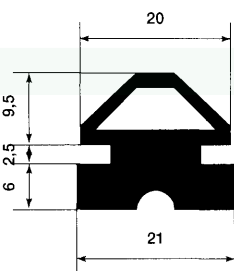

P 1756 gr./mt. 290 60 Sh

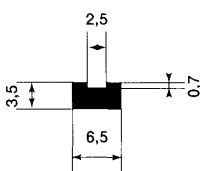

P 1757 gr./mt. 26 60 Sh

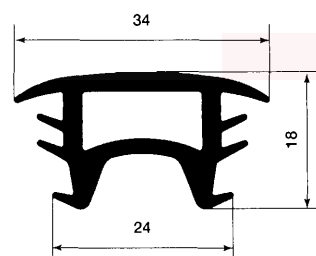

P 1758 gr./mt. 222 70 Sh

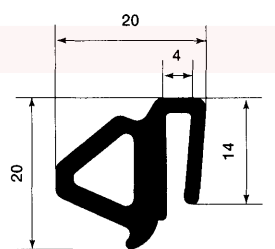

P 1759 gr./mt. 180 60 Sh

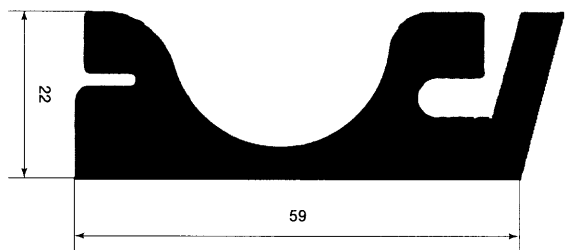

P 1760 gr./mt. 1205 50 Sh

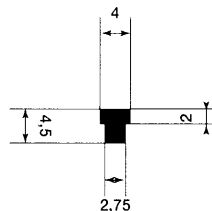

P 1761 gr./mt. 19 60 Sh

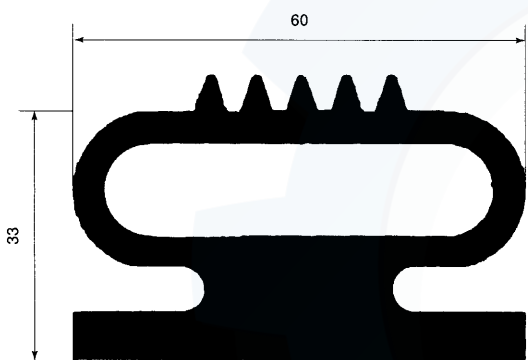

P 1762 gr./mt. 1500 70 Sh

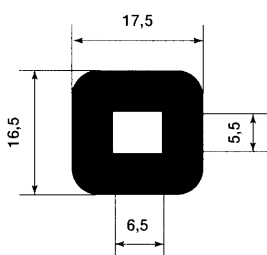

P 1763 gr./mt. 320 60 Sh

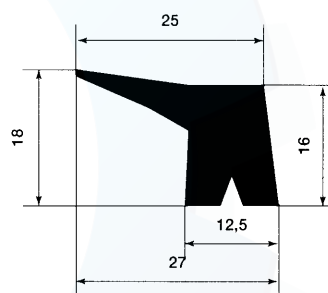

P 1764 gr./mt. 280 65 Sh

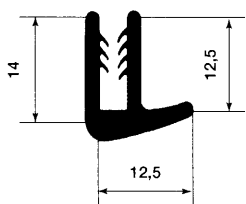

P 1765 gr./mt. 140 60 Sh

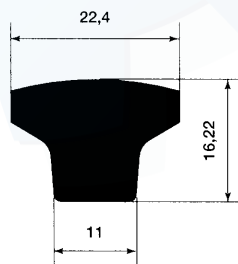

P 1767 gr./mt. 330 60 Sh

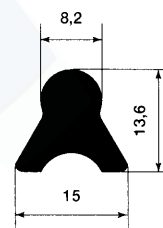

P 1768 gr./mt. 118 60 Sh

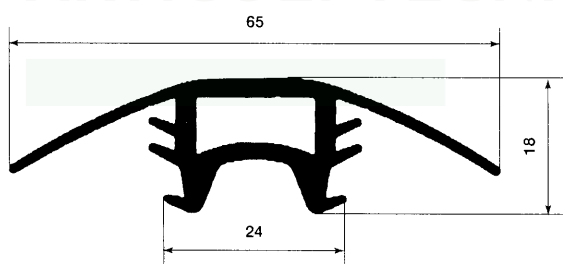

P 1769 gr./mt. 320 70 Sh

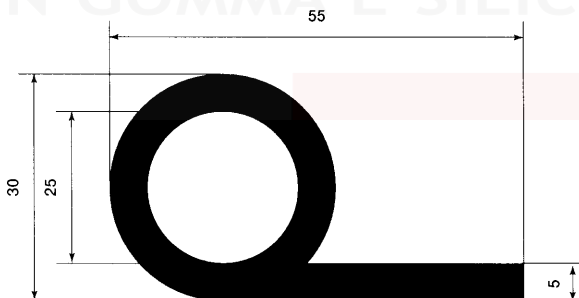

P 1770 gr./mt. 715 70 Sh

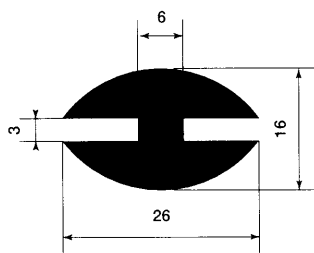

P 1771 gr./mt. 300 60 Sh

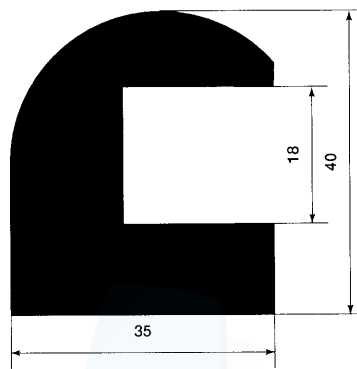

P 1772 gr./mt. 1100 60 Sh

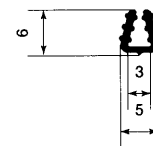

P 1773 gr./mt. 19 60 Sh

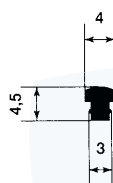

P 1774 gr./mt. 17 60 Sh

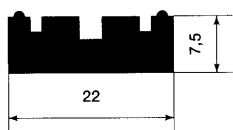

P 1775 gr./mt. 200 60 Sh

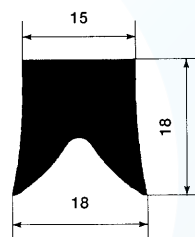

P 1776 gr./mt. 240 75 Sh

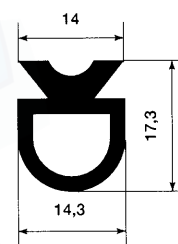

P 1777 gr./mt. 155 60 Sh

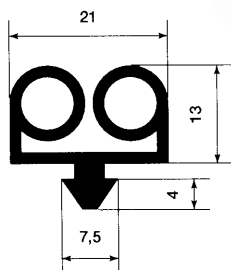

P 1778 gr./mt. 209 60 Sh

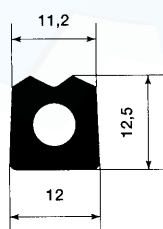

P 1779 gr./mt. 140 60 Sh

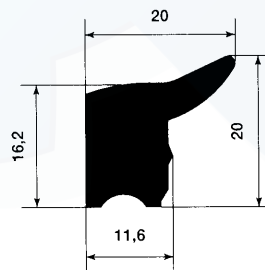

P 1780 gr./mt. 280 60 Sh

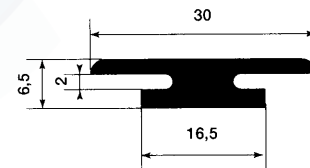

P 1781 gr./mt. 150 70 Sh

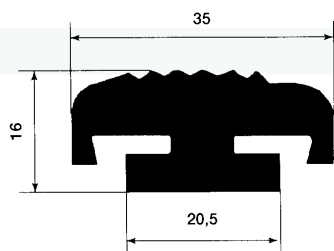

P 1782 gr./mt. 486 70 Sh

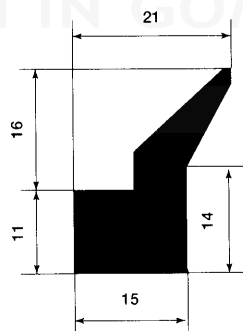

P 1783 gr./mt. 300 70 Sh

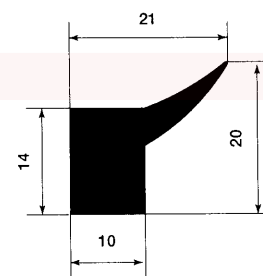

P 1784 gr./mt. 255 60 Sh

QUALITY LAW
ARTICOLI TECNICI IN GOMMA E SILICONE

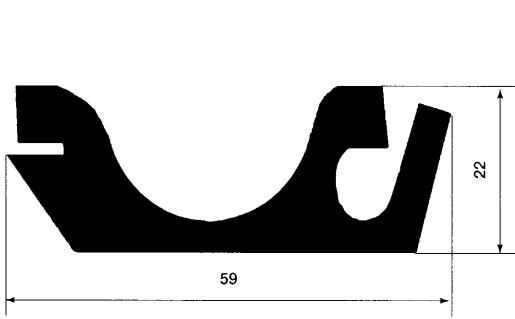

P 1785 gr./mt. 1200 50 Sh

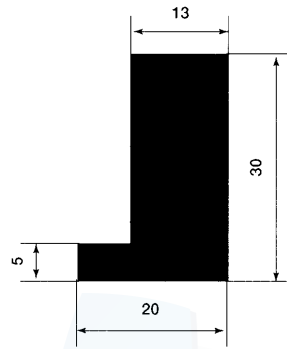

P 1786 gr./mt. 530 50 Sh

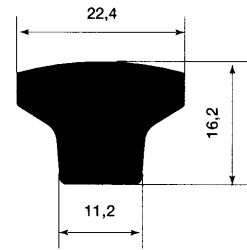

P 1787 gr./mt. 340 60 Sh

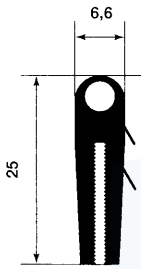

P 1788 gr./mt. 148 60 Sh

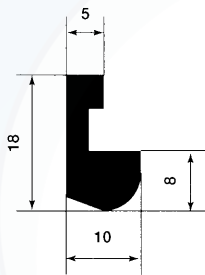

P 1789 gr./mt. 110 60 Sh

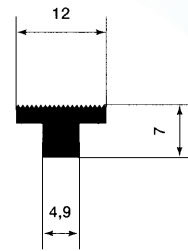

P 1790 gr./mt. 63 70 Sh

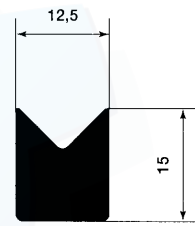

P 1791 gr./mt. 176 60 Sh

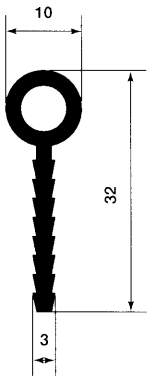

P 1792 gr./mt. 130 60 Sh

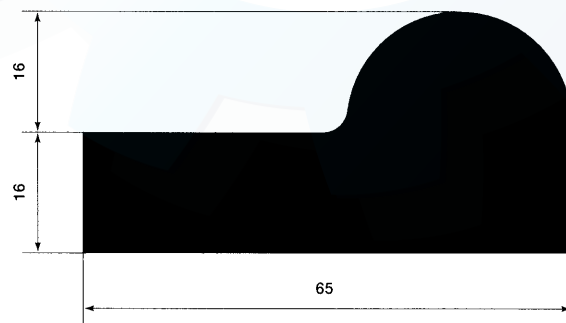

P 1793 gr./mt. 1740 60 Sh

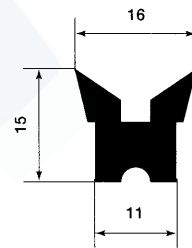

P 1794 gr./mt. 180 60 Sh

QUALITY LAW

ARTICOLI TECNICI IN GOMMA E SILICONE

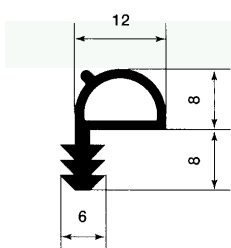

P 1795 gr./mt. 85 60 Sh

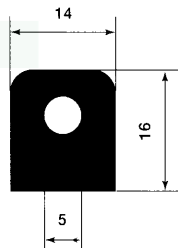

P 1796 gr./mt. 255 60 Sh

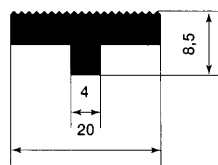

P 1797 gr./mt. 135 70 Sh

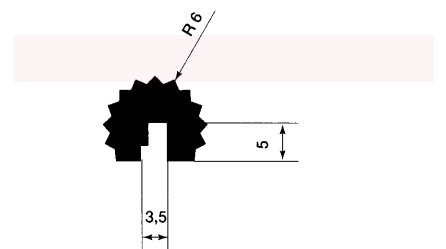

P 1798 gr./mt. 95 60 Sh

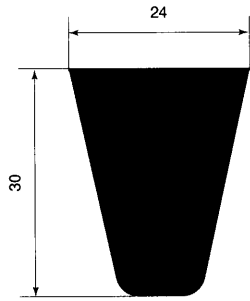

P 1799 gr./mt. 700 70 Sh

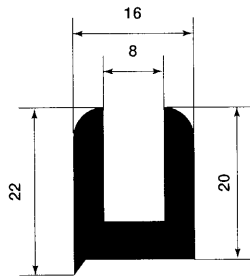

P 1800 gr./mt. 280 60 Sh

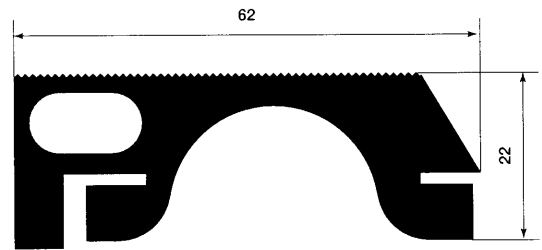

P 1801 gr./mt. 1200 50 Sh

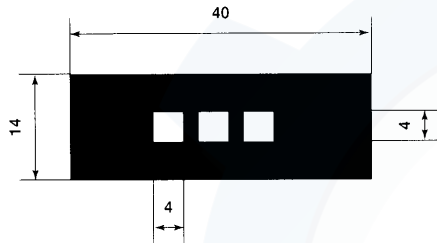

P 1802 gr./mt. 654 60 Sh

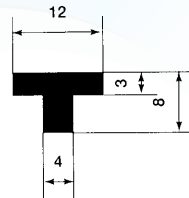

P 1803 gr./mt. 70 60 Sh

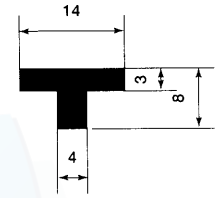

P 1804 gr./mt. 77 60 Sh

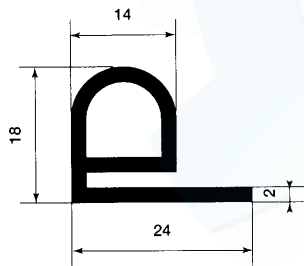

P 1805 gr./mt. 170 60 Sh

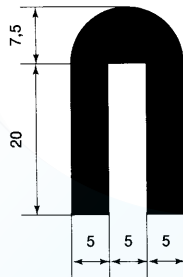

P 1806 gr./mt. 360 60 Sh

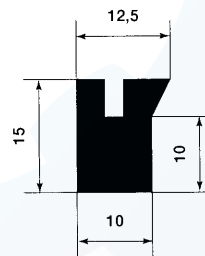

P 1807 gr./mt. 180 60 Sh

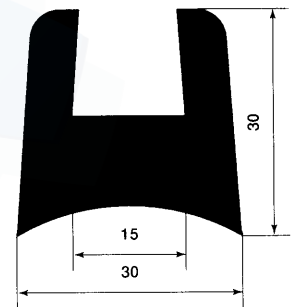

P 1808 gr./mt. 230 60 Sh



P 1809 gr./mt. 1625 60 Sh

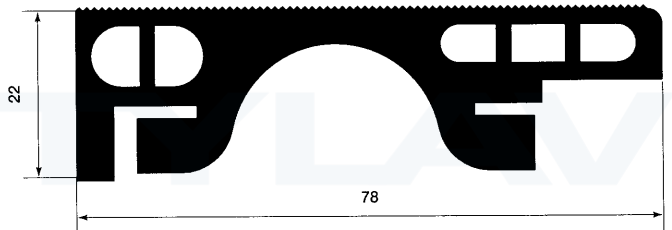

P 1810 gr./mt. 1200 50 Sh

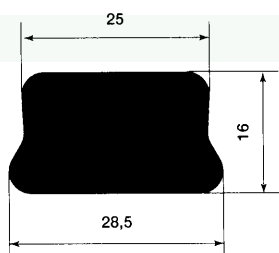

P 1811 gr./mt. 520 60 Sh

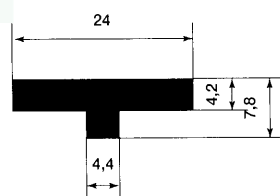

P 1812 gr./mt. 145 70 Sh

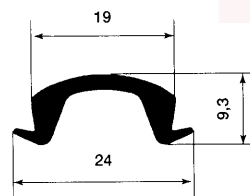

P 1813 gr./mt. 90 70 Sh

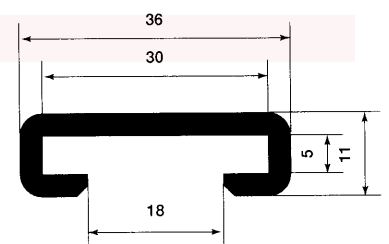

P 1814 gr./mt. 230 60 Sh

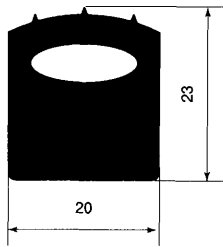

P 1815 gr./mt. 408 60 Sh

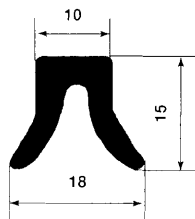

P 1816 gr./mt. 124 60 Sh

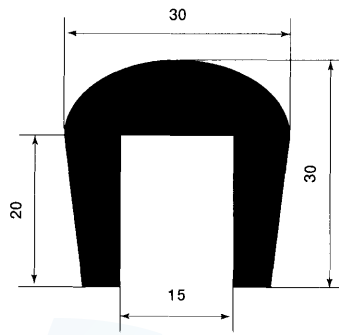

P 1817 gr./mt. 675 60 Sh

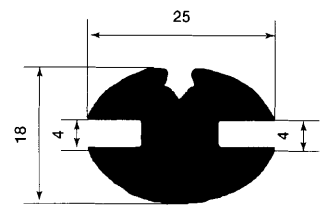

P 1818 gr./mt. 311 60 Sh

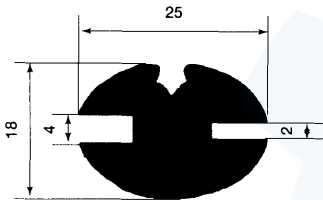

P 1819 gr./mt. 318 60 Sh

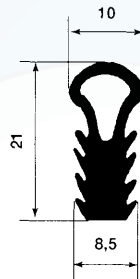

P 1820 gr./mt. 155 60 Sh

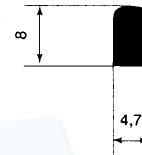

P 1821 gr./mt. 44 50 Sh

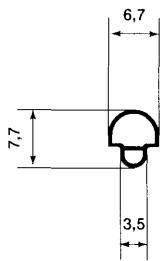

P 1822 gr./mt. 24 60 Sh

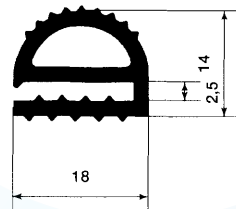

P 1823 gr./mt. 152 60 Sh

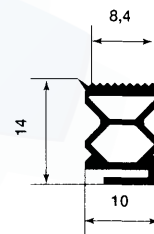

P 1824 gr./mt. 76 60 Sh



P 1825 gr./mt. 1400 60 Sh

QUALITYAV
 ARTICOLI TECNICI IN GOMMA SILICONE

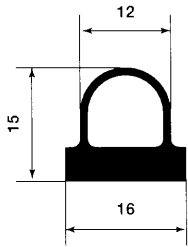

P 1826 gr./mt. 132 60 Sh

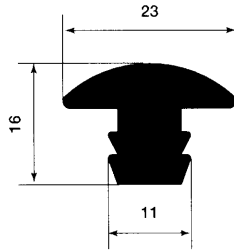

P 1827 gr./mt. 237 60 Sh

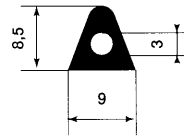

P 1828 gr./mt. 58 60 Sh

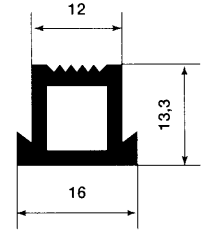

P 1829 gr./mt. 133 70 Sh

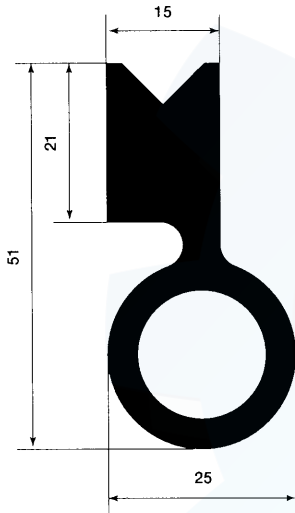

P 1830 gr./mt. 780 60 Sh

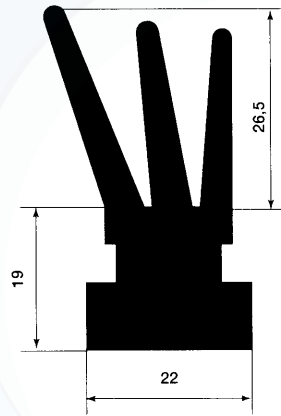

P 1831 gr./mt. 000 60 Sh

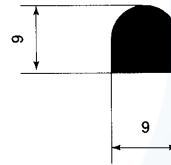

P 1832 gr./mt. 98 60 Sh

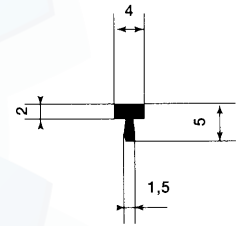

P 1833 gr./mt. 15 50 Sh

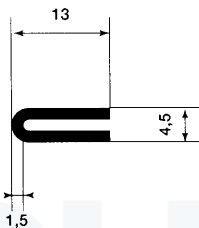

P 1834 gr./mt. 46 60 Sh

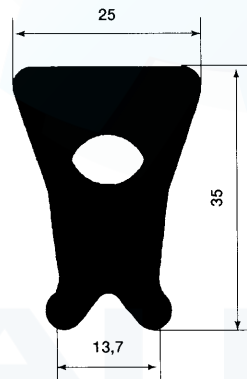

P 1835 gr./mt. 694 70 Sh

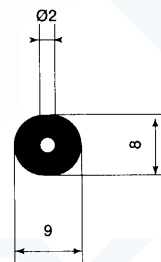

P 1836 gr./mt. 86 70 Sh

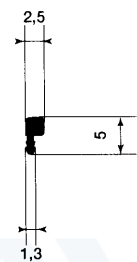

P 1837 gr./mt. 140 40 Sh

ARTICOLI TECNICI IN GOMMA E SILICONE

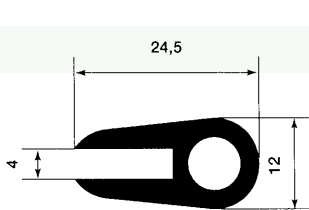

P 1838 gr./mt. 217 60 Sh

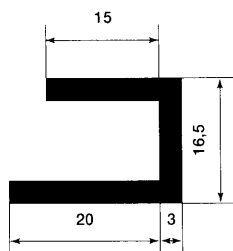

P 1839 gr./mt. 175 60 Sh

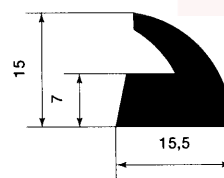

P 1840 gr./mt. 178 50 Sh

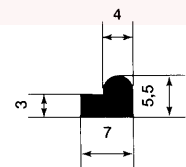

P 1841 gr./mt. 36 70 Sh

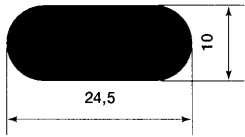

P 1842 gr./mt. 290 50 Sh

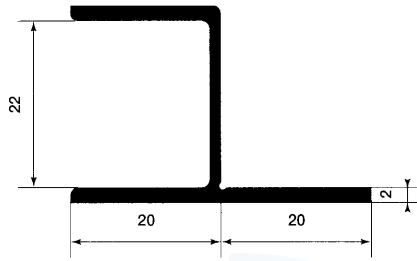

P 1843 gr./mt. 210 60 Sh

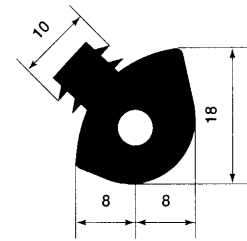

P 1844 gr./mt. 315 60 Sh

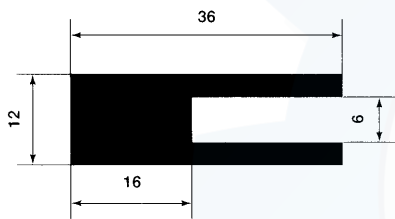

P 1845 gr./mt. 365 60 Sh

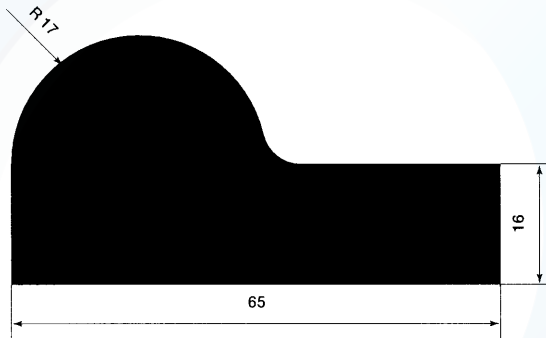

P 1846 gr./mt. 1980 60 Sh

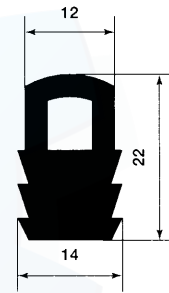

P 1847 gr./mt. 295 60 Sh

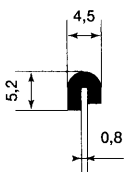

P 1848 gr./mt. 17 50 Sh

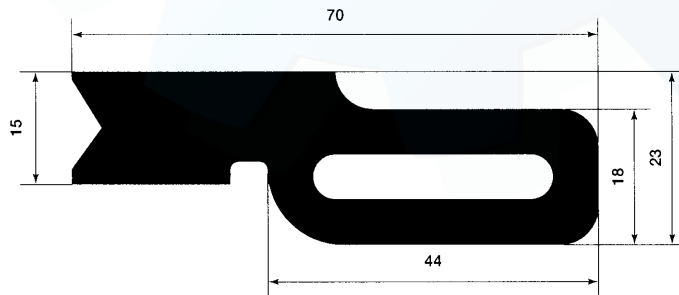

P 1849 gr./mt. 1150 70 Sh

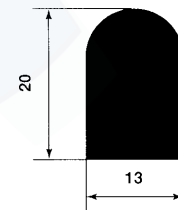

P 1850 gr./mt. 307 50 Sh

QUALITY LAW

ARTICOLI TECNICI IN GOMMA E SILICONE

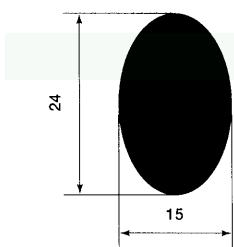

P 1851 gr./mt. 365 60 Sh

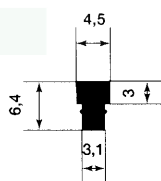

P 1852 gr./mt. 29 50 Sh

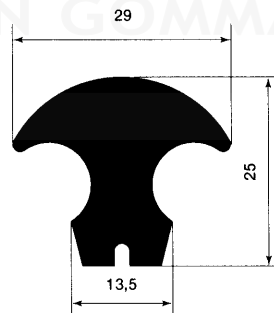

P 1853 gr./mt. 427 70 Sh

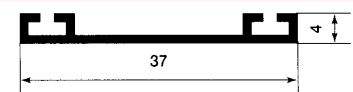

P 1854 gr./mt. 86 60 Sh

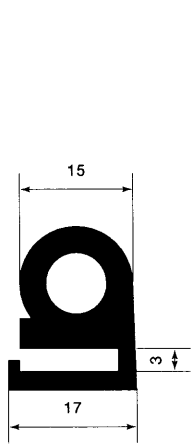

P 1855 gr./mt. 292 60 Sh

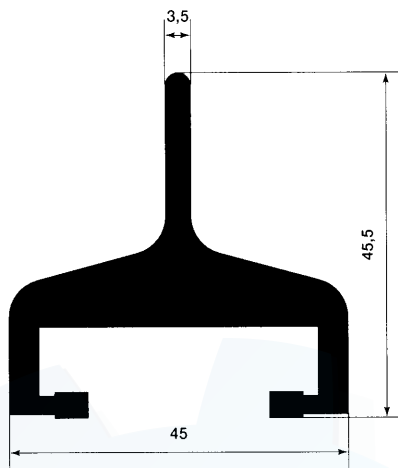

P 1856 gr./mt. 650 70 Sh

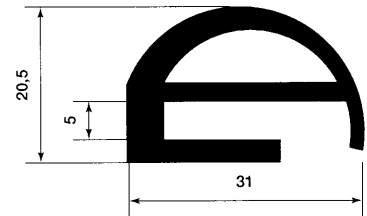

P 1857 gr./mt. 328 60 Sh

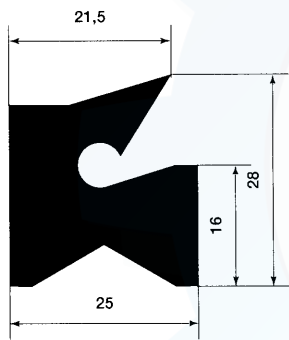

P 1858 gr./mt. 607 60 Sh

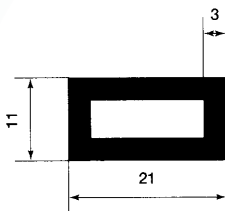

P 1859 gr./mt. 200 50 Sh

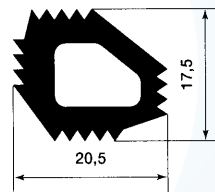

P 1860 gr./mt. 225 50 Sh

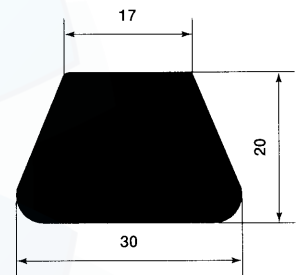

P 1861 gr./mt. 643 60 Sh

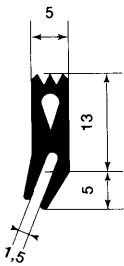

P 1862 gr./mt. 93 60 Sh

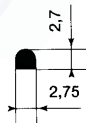

P 1863 gr./mt. 8,5 50 Sh



P 1864 gr./mt. 9 50 Sh

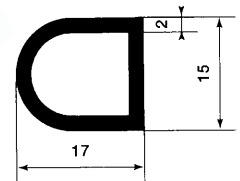

P 1865 gr./mt. 133 60 Sh

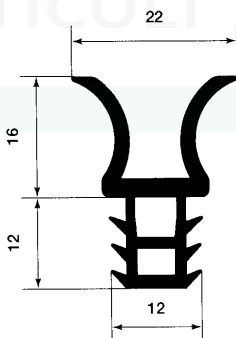

P 1866 gr./mt. 249 60 Sh

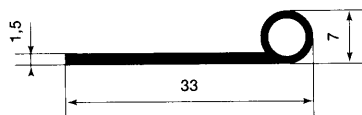

P 1867 gr./mt. 59 60 Sh

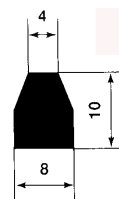

P 1868 gr./mt. 80 35 Sh

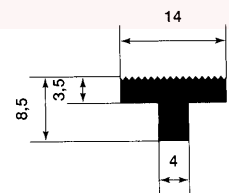

P 1869 gr./mt. 87 60 Sh

QUALITY LAY
ARTICOLI TECNICI IN GOMMA E SILICONE

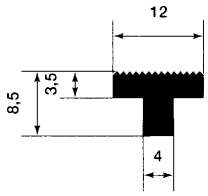

P 1870 gr./mt. 78 60 Sh

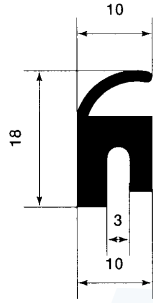

P 1871 gr./mt. 152 60 Sh

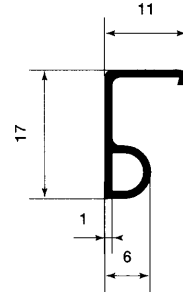

P 1872 gr./mt. 52 60 Sh

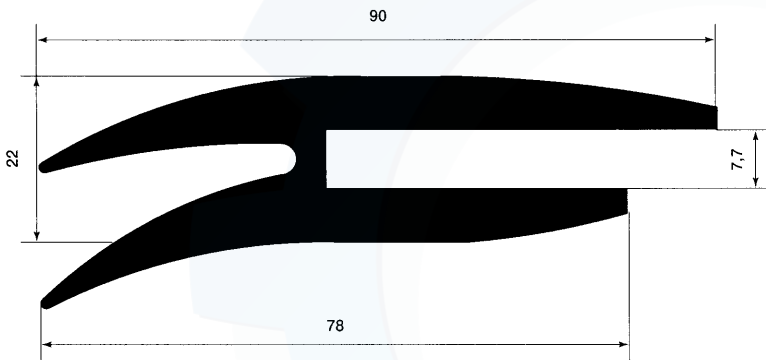

P 1873 gr./mt. 1300 60 Sh

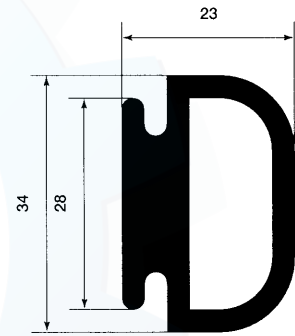

P 1874 gr./mt. 460 60 Sh

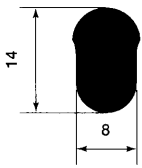

P 1875 gr./mt. 125 60 Sh

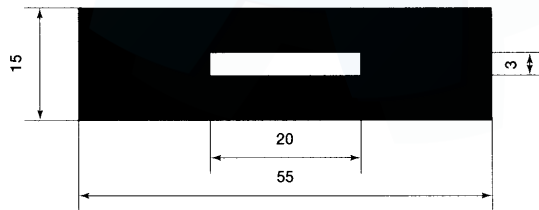

P 1876 gr./mt. 911 60 Sh

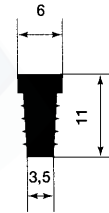

P 1877 gr./mt. 64 40 Sh

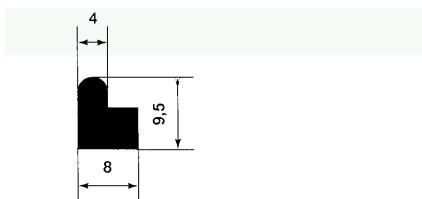

P 1878 gr./mt. 71 70 Sh

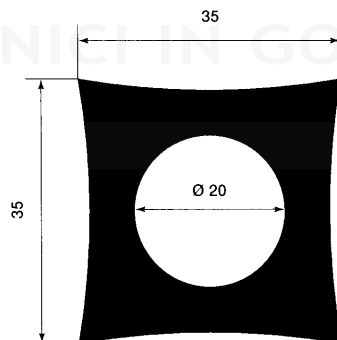

P 1879 gr./mt. 1140 50 Sh

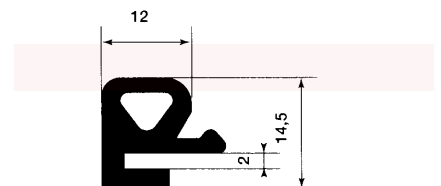

P 1880 gr./mt. 165 60 Sh

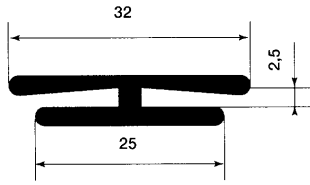

P 1881 gr./mt. 180 60 Sh

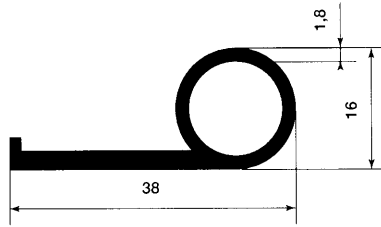

P 1882 gr./mt. 173 60 Sh

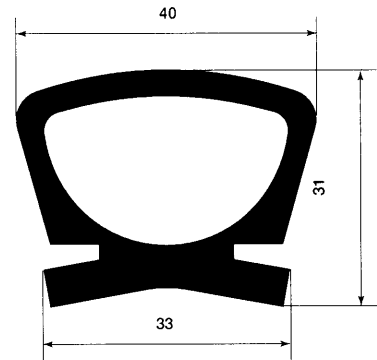

P 1883 gr./mt. 667 60 Sh

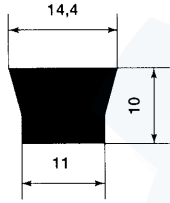

P 1884 gr./mt. 160 60 Sh

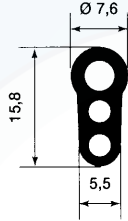

P 1885 gr./mt. 81 60 Sh

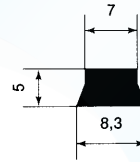

P 1886 gr./mt. 48 50 Sh

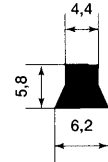

P 1887 gr./mt. 35 50 Sh

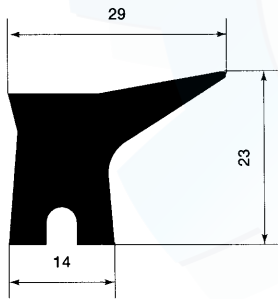

P 1888 gr./mt. 400 50 Sh

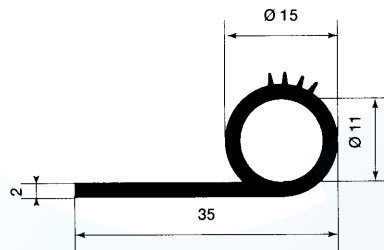

P 1889 gr./mt. 175 50 Sh

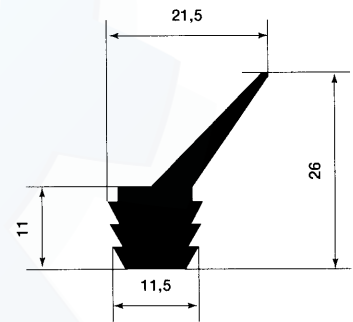

P 1890 gr./mt. 235 60 Sh

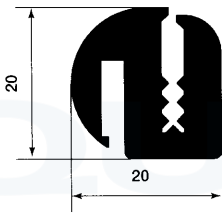

P 1891 gr./mt. 315 70 Sh

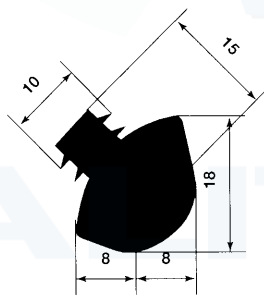

P 1892 gr./mt. 360 60 Sh

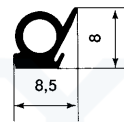

P 1893 gr./mt. 51 60 Sh

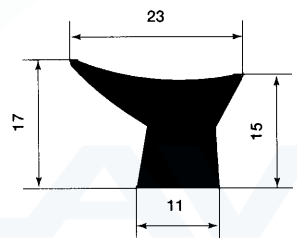

P 1894 gr./mt. 213 70 Sh

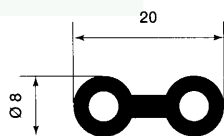

P 1895 gr./mt. 95 60 Sh

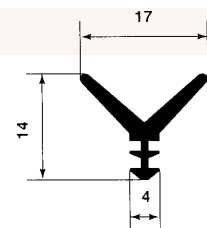

P 1896 gr./mt. 57 60 Sh

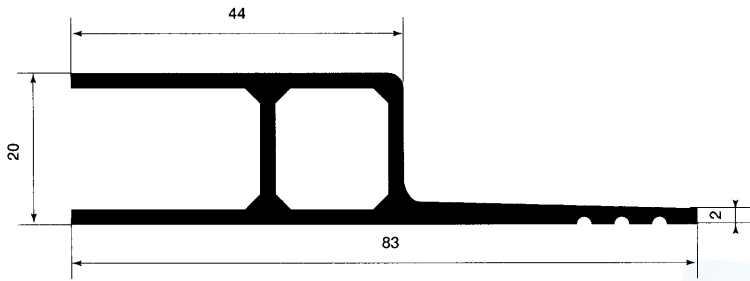

P 1897 gr./mt. 460 70 Sh

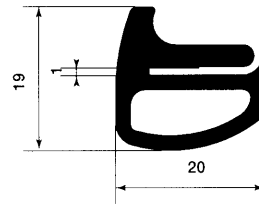

P 1898 gr./mt. 175 60 Sh

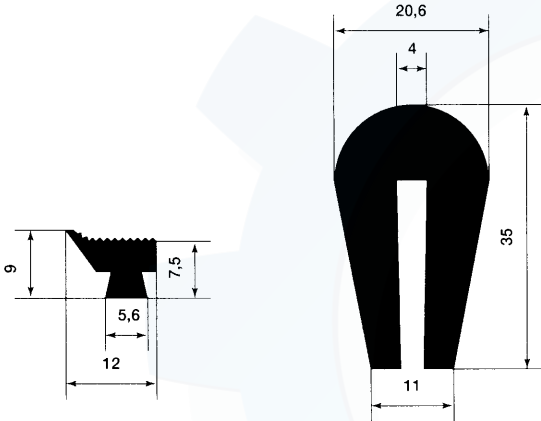

P 1899 gr./mt. 74 70 Sh

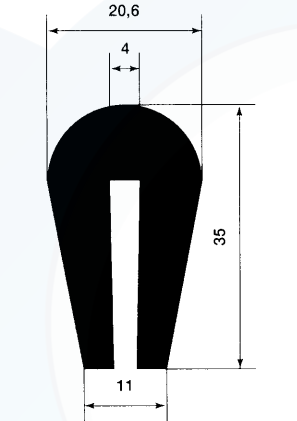

P 1900 gr./mt. 600 60 Sh

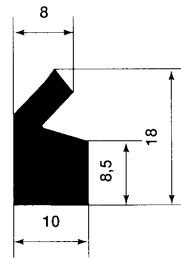

P 1901 gr./mt. 154 60 Sh

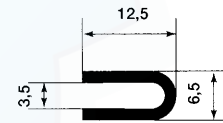

P 1902 gr./mt. 62 70 Sh

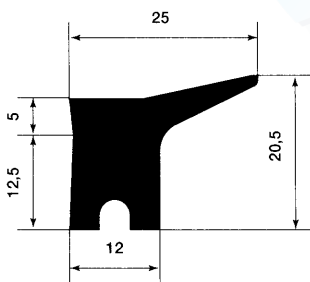

P 1903 gr./mt. 280 50 Sh

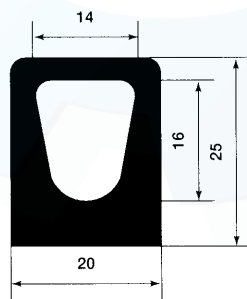

P 1904 gr./mt. 390 50 Sh

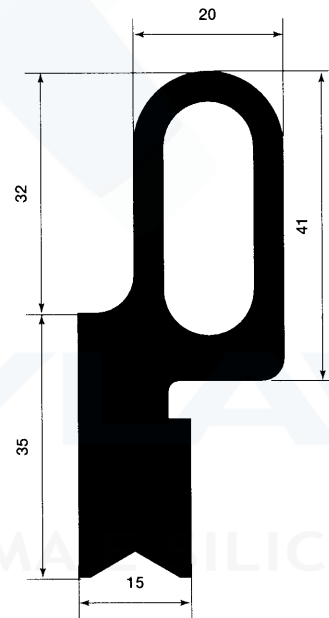

P 1905 gr./mt. 1135 60 Sh

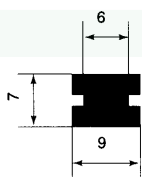

P 1906 gr./mt. 68 40 Sh

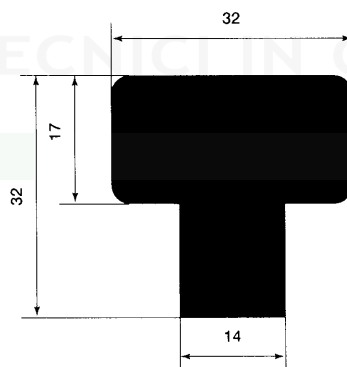

P 1907 gr./mt. 965 60 Sh

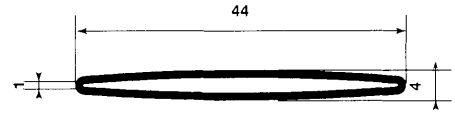
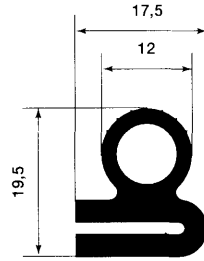
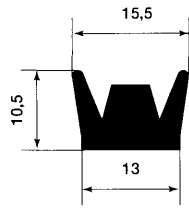

P 1908 gr./mt. 151 70 Sh

P 1909 gr./mt. 219 50 Sh

P 1910 gr./mt. 113 60 Sh

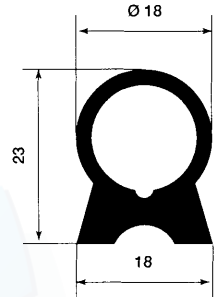
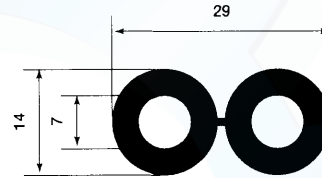
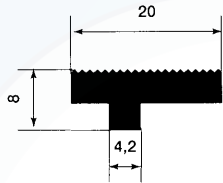
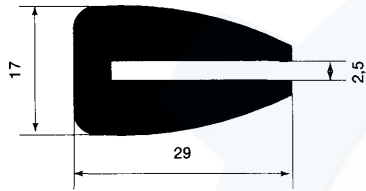

P 1911 gr./mt. 360 40 Sh

P 1912 gr./mt. 137 60 Sh

P 1913 gr./mt. 270 60 Sh

P 1914 gr./mt. 210 50 Sh

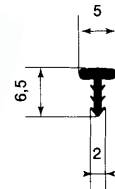
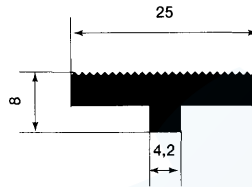
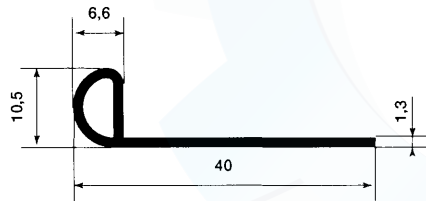

P 1915 gr./mt. 93 60 Sh

P 1916 gr./mt. 165 60 Sh

P 1917 gr./mt. 19 60 Sh

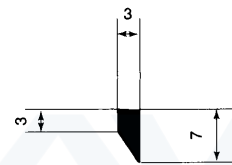
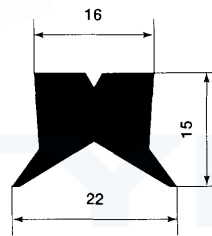

P 1918 gr./mt. 665 60 Sh

P 1919 gr./mt. 206 60 Sh

P 1920 gr./mt. 20 60 Sh

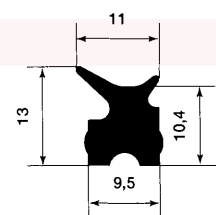
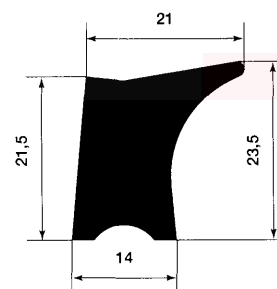
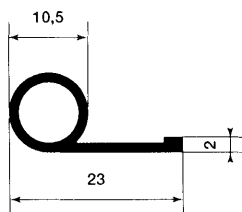
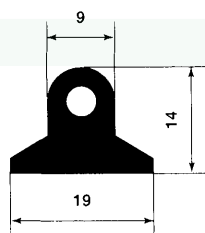

P 1921 gr./mt. 163 60 Sh

P 1922 gr./mt. 69 60 Sh

P 1923 gr./mt. 443 60 Sh

P 1924 gr./mt. 124 75 Sh

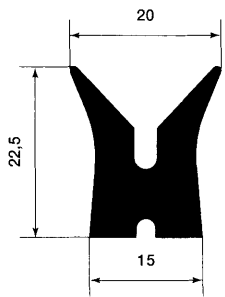

P 1925 gr./mt. 268 50 Sh

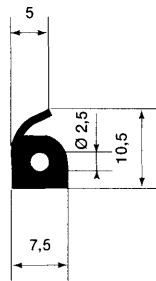

P 1926 gr./mt. 65 50 Sh

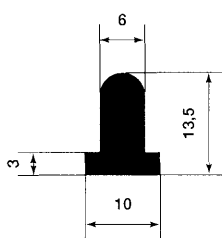

P 1927 gr./mt. 116 60 Sh

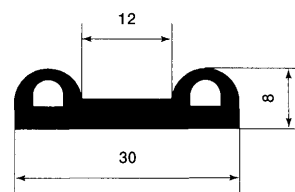

P 1928 gr./mt. 177 60 Sh

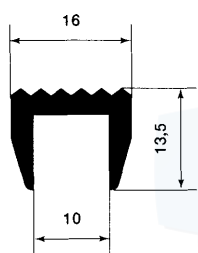

P 1929 gr./mt. 112 60 Sh

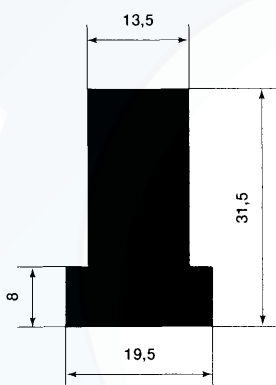

P 1930 gr./mt. 544 50 Sh

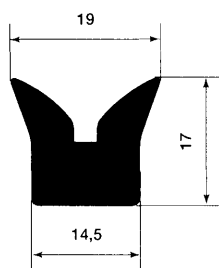

P 1931 gr./mt. 232 60 Sh

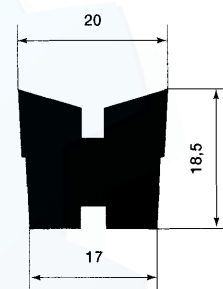

P 1932 gr./mt. 330 40 Sh

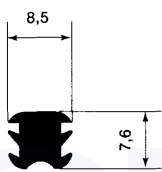

P 1933 gr./mt. 60 60 Sh

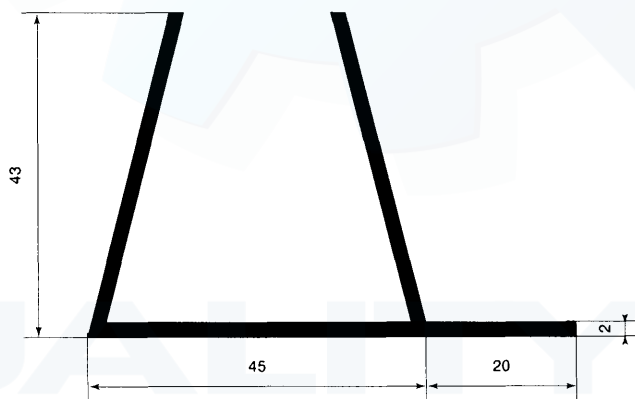

P 1934 gr./mt. 387 60 Sh

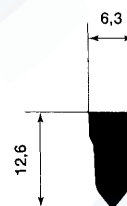

P 1935 gr./mt. 70 60 Sh

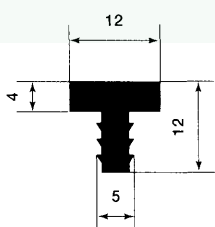

P 1936 gr./mt. 103 50 Sh

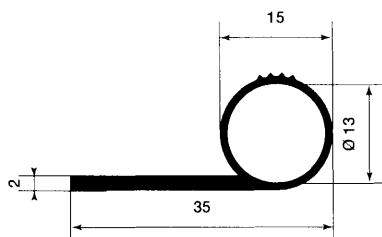

P 1937 gr./mt. 116 50 Sh

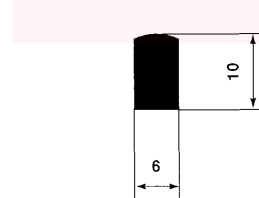

P 1938 gr./mt. 78 60 Sh

ARTICOLI TECNICI IN GOMMA E SILICONE



P 1939 gr./mt. 25 60 Sh

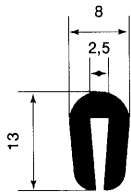

P 1940 gr./mt. 95 60 Sh

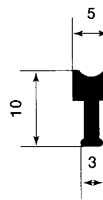

P 1941 gr./mt. 38 70 Sh

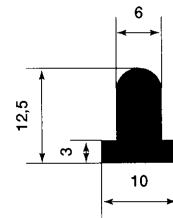

P 1942 gr./mt. 107 60 Sh

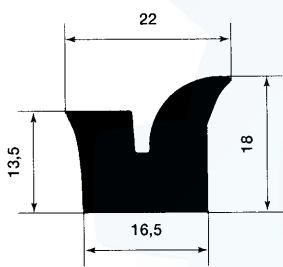

P 1943 gr./mt. 273 60 Sh

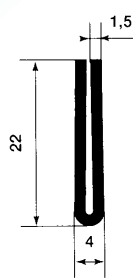

P 1944 gr./mt. 77 60 Sh

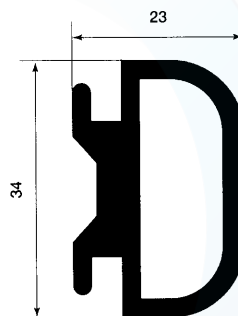

P 1945 gr./mt. 428 70 Sh

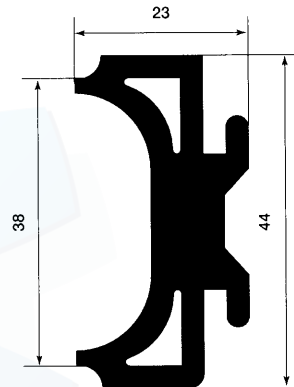

P 1946 gr./mt. 490 70 Sh

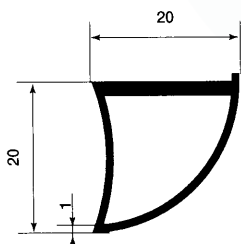

P 1947 gr./mt. 113 70 Sh

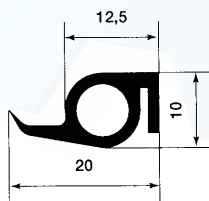

P 1948 gr./mt. 98 60 Sh

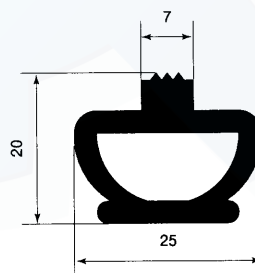

P 1949 gr./mt. 283 60 Sh

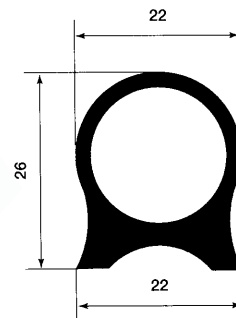

P 1950 gr./mt. 273 50 Sh

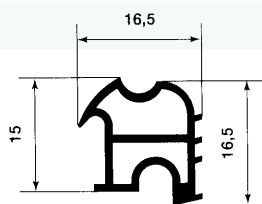

P 1951 gr./mt. 110 70 Sh

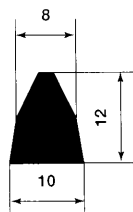

P 1952 gr./mt. 102 50 Sh



P 1953 gr./mt. 527 50 Sh

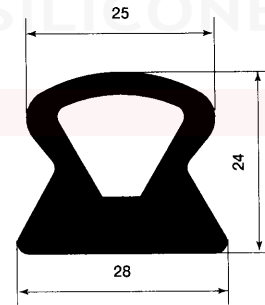

P 1954 gr./mt. 451 50 Sh

QUALITYLAV
ARTICOLI TECNICI IN GOMMA E SILIGONE

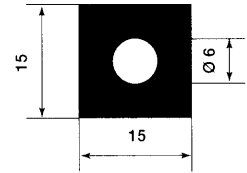
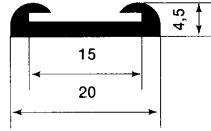
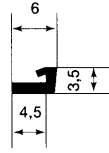
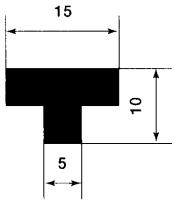

P 1955 gr./mt. 123 70 Sh

P 1956 gr./mt. 15 75 Sh

P 1957 gr./mt. 70 60 Sh

P 1958 gr./mt. 253 60 Sh

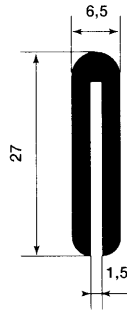
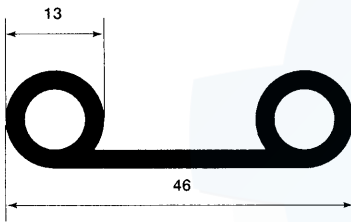

P 1959 gr./mt. 260 60 Sh

P 1960 gr./mt. 167 60 Sh

P 1961 gr./mt. 12 60 Sh

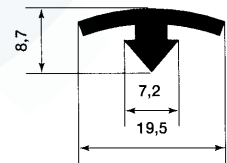
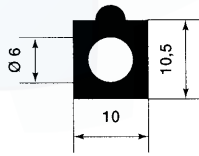
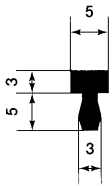

P 1962 gr./mt. 37 75 Sh

P 1963 gr./mt. 33 75 Sh

P 1964 gr./mt. 108 70 Sh

P 1965 gr./mt. 90 60 Sh

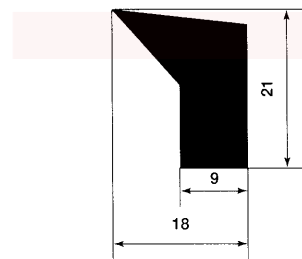
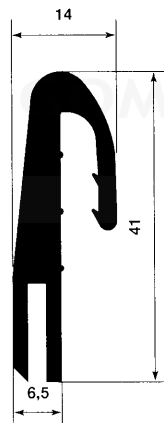
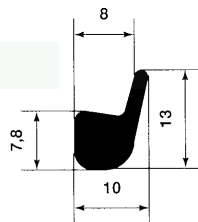
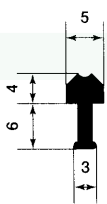

P 1966 gr./mt. 37 70 Sh

P 1967 gr./mt. 110 75 Sh

P 1968 gr./mt. 330 70 Sh

P 1969 gr./mt. 287 60 Sh

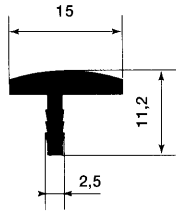

P 1970 gr./mt. 75 60 Sh

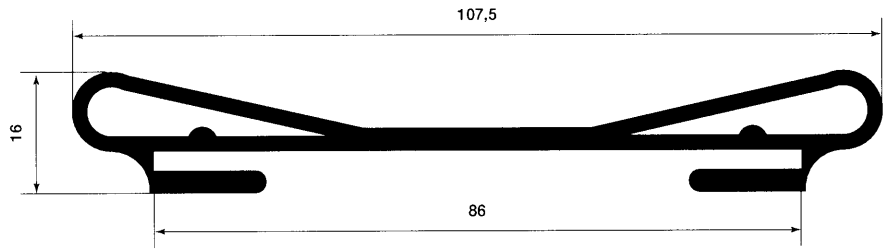

P 1971 gr./mt. 670 60 Sh

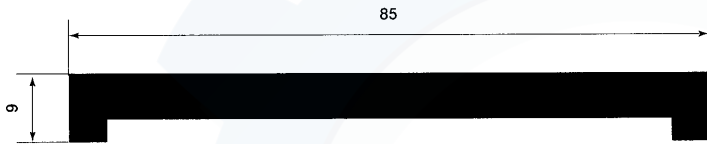

P 1972 gr./mt. 645 60 Sh

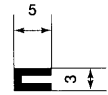

P 1973 gr./mt. 28 60 Sh

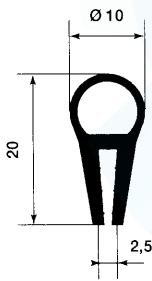

P 1974 gr./mt. 92 60 Sh

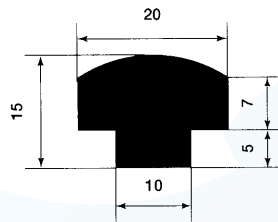

P 1975 gr./mt. 290 60 Sh

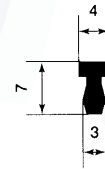

P 1976 gr./mt. 28 75 Sh

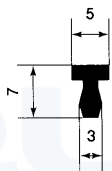

P 1977 gr./mt. 30 75 Sh

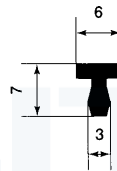

P 1978 gr./mt. 33 75 Sh

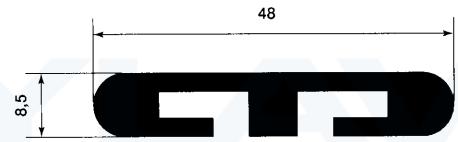

P 1979 gr./mt. 396 70 Sh

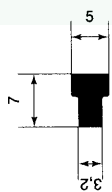

P 1980 gr./mt. 33 50 Sh

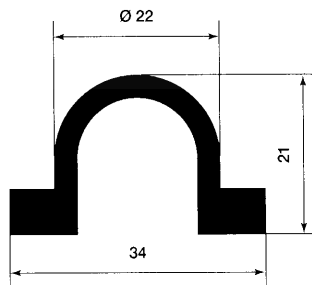

P 1981 gr./mt. 290 60 Sh

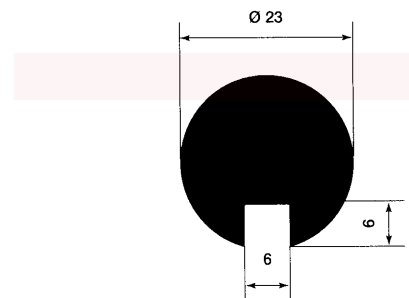

P 1982 gr./mt. 455 60 Sh

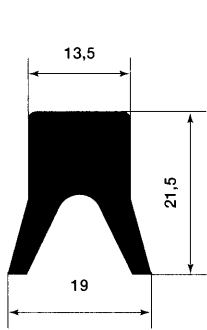

P 1983 gr./mt. 280 70 Sh

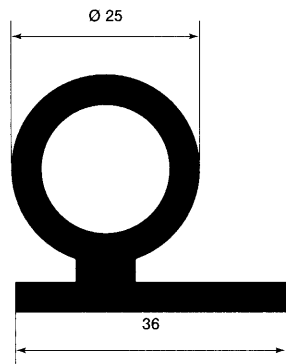

P 1984 gr./mt. 565 60 Sh

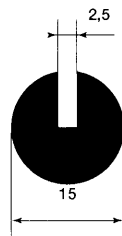

P 1985 gr./mt. 181 50 Sh

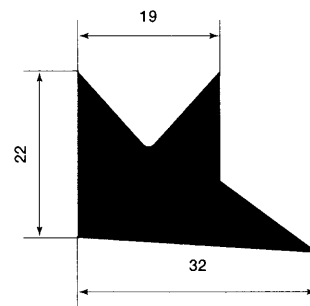

P 1986 gr./mt. 443 60 Sh

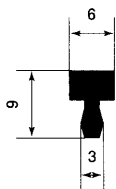

P 1987 gr./mt. 49 75 Sh

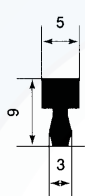

P 1988 gr./mt. 43 75 Sh

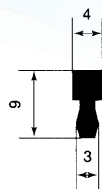

P 1989 gr./mt. 38 75 Sh

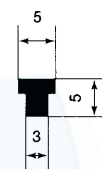

P 1990 gr./mt. 24 70 Sh

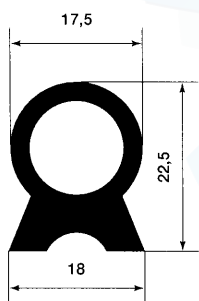

P 1991 gr./mt. 234 60 Sh



P 1992 gr./mt. 51 60 Sh

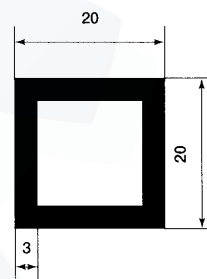

P 1993 gr./mt. 243 60 Sh

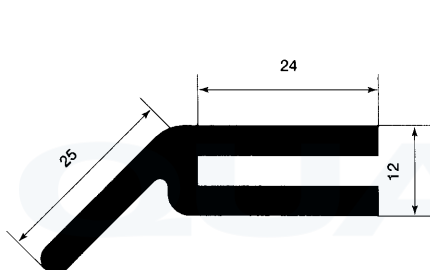

P 1994 gr./mt. 403 60 Sh

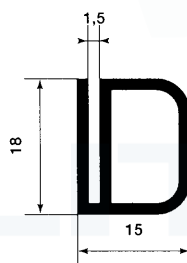

P 1995 gr./mt. 125 60 Sh

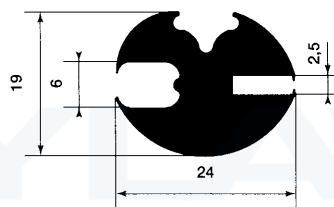

P 1996 gr./mt. 300 50 Sh

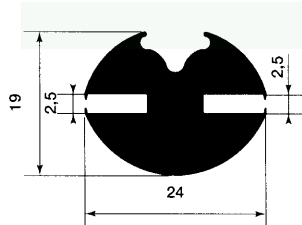

P 1997 gr./mt. 330 50 Sh

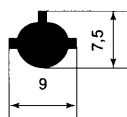

P 1998 gr./mt. 70 70 Sh

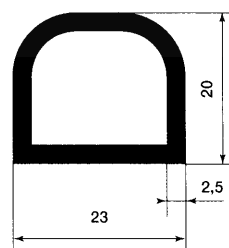

P 1999 gr./mt. 230 60 Sh

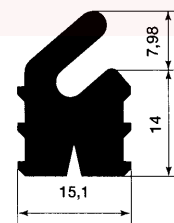

P 2000 gr./mt. 250 60 Sh



Quality Lav S.r.l.s.

Articoli Tecnici in Gomma e Silicone

Corso Montello, 6 - 20822 Seveso (MB) IT
Tel: +39 389 8368431
P.I. C.F. 12522320964 – REA: MB-2667352

E-Mail: info@qualitylav.it
Pec: qualitylav@pec.it
Web: <http://www.qualitylav.it/>